



# RETAIL PRICE LIST 2024

EFFECTIVE APRIL 2024



# Contents

<b>Caretron™</b> MINIATURE CIRCUIT BREAKER (MCBs) .....	02 - 04
<b>Caretron™</b> ISOLATOR .....	04
<b>Caretron™</b> RESIDUAL CURRENT CIRCUIT BREAKER (RCCBs) .....	04
—optipro™— MINIATURE CIRCUIT BREAKER (MCBs) .....	05 - 06
—optipro™— ISOLATOR .....	06
AUTOMATIC CHANGEOVER WITH CURRENT LIMITER (ACCL) .....	07
<b>Caretron™+</b> DISTRIBUTION BOARDS (DBs) .....	08 - 11
BUSBAR CHAMBER .....	11
TIME SWITCHES .....	12
—optium™— MCCB - 1.0 (FIXED TM RANGE) .....	13 - 15
—optium™— MCCB - 1.1 (FIXED TM RANGE) .....	16
—optium™— MCCB - 2.0 (ADJUSTABLE TM RANGE) .....	16 - 18
—optium™— MCCB - ACCESSORIES .....	18 - 19
<b>NEW</b> —optinova™— SWITCH DISCONNECTOR / TSE (ONLOAD CHANGEOVER) .....	20 - 23
HRC FUSE LINKS & BASES .....	24
SWITCH DISCONNECTOR FUSES .....	25
<b>Ambidex</b> CHANGEOVER SWITCHES .....	26 - 27
<b>Shynora</b> WIRING ACCESSORIES .....	28 - 39
METAL & PLASTIC SURFACE BOX .....	38,45,52
<b>Glint™</b> WIRING ACCESSORIES .....	40 - 46
<b>ELVIRA</b> WIRING ACCESSORIES .....	47 - 53
<b>Zosta™</b> EXHAUST FAN .....	54 - 55
INDOASIAN PLUGS .....	55
FANCY BATTEN BULB HOLDER / CEILING ROSE .....	55 - 56

EXPERIENCE HAPPINESS THROUGH  
SAFE & SECURE PRODUCTS



**Caretron**<sup>™</sup> | MCB | RCCB



**Caretron™ MINIATURE CIRCUIT BREAKER - MCB**

- ISI / CE Marked as per IS/IEC 60898 - 1 • Degree of Protection IP 20 • 25 sq. mm Terminals • Breaking Capacity 6kA
- Bi-Connect Terminals • Positive Isolation • Frequency 50Hz • Operating Voltage 240V / 415V AC, 60V DC per Pole

**B CURVE SINGLE POLE**

**HSN Code: 8536**

	Rating (A)	Pack	Cat. Nos.	Unit Price (₹)
	6	1/12/180	810000	211
10	1/12/180	810001	211	
16	1/12/180	810002	211	
20	1/12/180	810003	211	
25	1/12/180	810004	211	
32	1/12/180	810005	211	
40	1/12/180	810006	468	
50	1/12/180	810007	524	
63	1/12/180	810008	524	

**B CURVE SINGLE POLE NEUTRAL**

**HSN Code: 8536**

	Rating (A)	Pack	Cat. Nos.	Unit Price (₹)
	6	1/6/90	810009	704
10	1/6/90	810010	704	
16	1/6/90	810011	704	
20	1/6/90	810012	704	
25	1/6/90	810013	704	
32	1/6/90	810014	704	
40	1/6/90	810015	1017	
50	1/6/90	810016	1124	
63	1/6/90	810017	1124	

**B CURVE DOUBLE POLE**

**HSN Code: 8536**

	Rating (A)	Pack	Cat. Nos.	Unit Price (₹)
	6	1/6/90	810018	740
10	1/6/90	810019	740	
16	1/6/90	810020	740	
20	1/6/90	810021	740	
25	1/6/90	810022	740	
32	1/6/90	810023	740	
40	1/6/90	810024	1078	
50	1/6/90	810025	1206	
63	1/6/90	810026	1206	

**C CURVE SINGLE POLE**

**HSN Code: 8536**

	Rating (A)	Pack	Cat. Nos.	Unit Price (₹)
	6	1/12/180	810054	213
10	1/12/180	810055	213	
16	1/12/180	810056	213	
20	1/12/180	810057	213	
25	1/12/180	810058	213	
32	1/12/180	810059	213	
40	1/12/180	810060	484	
50	1/12/180	810061	564	
63	1/12/180	810062	564	

**Caretron™ MINIATURE CIRCUIT BREAKER - MCB**

- ISI / CE Marked as per IS/IEC 60898 - 1 • Degree of Protection IP 20 • 25 sq. mm Terminals • Breaking Capacity 6kA
- Bi-Connect Terminals • Positive Isolation • Frequency 50Hz • Operating Voltage 240V / 415V AC, 60V DC per Pole

**C CURVE SINGLE POLE NEUTRAL**

**HSN Code: 8536**

	Rating (A)	Pack	Cat. Nos.	Unit Price (₹)
	6	1/6/90	810063	784
10	1/6/90	810064	784	
16	1/6/90	810065	784	
20	1/6/90	810066	784	
25	1/6/90	810067	784	
32	1/6/90	810068	784	
40	1/6/90	810069	1088	
50	1/6/90	810070	1286	
63	1/6/90	810071	1286	

**C CURVE DOUBLE POLE**

**HSN Code: 8536**

	Rating (A)	Pack	Cat. Nos.	Unit Price (₹)
	6	1/6/90	810072	792
10	1/6/90	810073	792	
16	1/6/90	810074	792	
20	1/6/90	810075	792	
25	1/6/90	810076	792	
32	1/6/90	810077	792	
40	1/6/90	810078	1158	
50	1/6/90	810079	1306	
63	1/6/90	810080	1306	

**C CURVE THREE POLE**

**HSN Code: 8536**

	Rating (A)	Pack	Cat. Nos.	Unit Price (₹)
	6	1/4/60	810081	1297
10	1/4/60	810082	1297	
16	1/4/60	810083	1297	
20	1/4/60	810084	1297	
25	1/4/60	810085	1297	
32	1/4/60	810086	1297	
40	1/4/60	810087	1824	
50	1/4/60	810088	2007	
63	1/4/60	810089	2007	

**C CURVE THREE POLE NEUTRAL**

**HSN Code: 8536**

	Rating (A)	Pack	Cat. Nos.	Unit Price (₹)
	6	1/3/45	810090	1710
10	1/3/45	810091	1710	
16	1/3/45	810092	1710	
20	1/3/45	810093	1710	
25	1/3/45	810094	1710	
32	1/3/45	810095	1710	
40	1/3/45	810096	2268	
50	1/3/45	810097	2470	
63	1/3/45	810098	2470	

**Caretron™ MINIATURE CIRCUIT BREAKER - MCB**

**C CURVE FOUR POLE**

**HSN Code: 8536**

	Rating (A)	Pack	Cat. Nos.	Unit Price (₹)
	6	1/3/45	810099	1726
10	1/3/45	810100	1726	
16	1/3/45	810101	1726	
20	1/3/45	810102	1726	
25	1/3/45	810103	1726	
32	1/3/45	810104	1726	
40	1/3/45	810105	2292	
50	1/3/45	810106	2508	
63	1/3/45	810107	2508	

**Caretron™ ISOLATOR**

- Conforms to IEC 60947-3 • Bi-Connect Terminals • Positive Isolation
- Degree of Protection IP 20 • 25 sq. mm Terminals

**DOUBLE POLE**

**HSN Code: 8536**

	Rating (A)	Pack	Cat. Nos.	Unit Price (₹)
	40	1/6/90	810130	526
63	1/6/90	810131	651	

**THREE POLE**

**HSN Code: 8536**

	Rating (A)	Pack	Cat. Nos.	Unit Price (₹)
	40	1/4/60	810132	946
63	1/4/60	810133	1063	

**FOUR POLE**

**HSN Code: 8536**

	Rating (A)	Pack	Cat. Nos.	Unit Price (₹)
	40	1/3/45	810134	1171
63	1/3/45	810135	1229	

**Caretron™ RESIDUAL CURRENT CIRCUIT BREAKER - RCCB**

- ISI/CE marked as per IS/IEC12640 • Rated Conditional Short Circuit Current, ICC6kA
- Degree of Protection IP 20 • Bi-Connect Terminals • 25 sq. mm Terminals

**DOUBLE POLE**

**HSN Code: 8536**

	Rating (A)	Sensitivity	Pack	Cat. Nos.	Unit Price (₹)
	25	30 mA	1/6/90	810150	2710
25	100 mA	1/6/90	810153	2800	
25	300 mA	1/6/90	810156	2800	
40	30 mA	1/6/90	810151	3003	
40	100 mA	1/6/90	810154	3049	
40	300 mA	1/6/90	810157	3049	
63	30 mA	1/6/90	810152	3823	
63	100 mA	1/6/90	810155	3865	
63	300 mA	1/6/90	810158	3865	

**FOUR POLE**

**HSN Code: 8536**

	Rating (A)	Sensitivity	Pack	Cat. Nos.	Unit Price (₹)
	25	30 mA	1/3/45	810159	3550
25	100 mA	1/3/45	810162	3612	
25	300 mA	1/3/45	810165	3612	
40	30 mA	1/3/45	810160	3624	
40	100 mA	1/3/45	810163	3688	
40	300 mA	1/3/45	810166	3688	
63	30 mA	1/3/45	810161	4026	
63	100 mA	1/3/45	810164	4088	
63	300 mA	1/3/45	810167	4088	



— optipro<sup>™</sup> —

**RCCB & MCB**

ALL THAT YOU NEED

*Engineered to perfection with wide range and unmatched quality.*

**Contact Indication Window-**  
Visual indication ensure  
safety of end user

**Low Power  
Loss**





—optipro— **MINIATURE CIRCUIT BREAKER - MCB**

- ISI / CE Marked as per IS/IEC 60898 - 1 • Rated Short-Circuit Breaking Capacity, Icn 10kA • Degree of Protection IP 20
- Energy Limitation Class 3 • Line Load Reversibility • 35 sq. mm Terminals • Biconnect Terminals • Frequency: 50 Hz
- Operating Voltage : 240V/415V AC , 60V DC per pole

**B CURVE SINGLE POLE**

**HSN Code: 8536**

	Rating (A)	Pack	Cat. Nos.	Unit Price (₹)
	6	1/12/180	811008	265
10	1/12/180	811010	265	
16	1/12/180	811012	265	
20	1/12/180	811013	265	
25	1/12/180	811014	265	
32	1/12/180	811015	265	
40	1/12/180	811016	597	
50	1/12/180	811017	695	
63	1/12/180	811018	695	

**B CURVE SINGLE POLE NEUTRAL**

**HSN Code: 8536**

	Rating (A)	Pack	Cat. Nos.	Unit Price (₹)
	6	1/6/90	811027	892
10	1/6/90	811029	892	
16	1/6/90	811031	892	
20	1/6/90	811032	892	
25	1/6/90	811033	892	
32	1/6/90	811034	892	
40	1/6/90	811035	1248	
50	1/6/90	811036	1415	
63	1/6/90	811037	1415	

**B CURVE DOUBLE POLE**

**HSN Code: 8536**

	Rating (A)	Pack	Cat. Nos.	Unit Price (₹)
	6	1/6/90	811046	926
10	1/6/90	811048	926	
16	1/6/90	811050	926	
20	1/6/90	811051	926	
25	1/6/90	811052	926	
32	1/6/90	811053	926	
40	1/6/90	811054	1334	
50	1/6/90	811055	1487	
63	1/6/90	811056	1487	

—optipro— **ISOLATOR**

- Conforms to IEC 60947-3 • CE Marked • Degree of Protection IP 20 • 35 sq. mm Terminals • Biconnect Terminals
- Frequency: 50 Hz • Operating Voltage: 240V/415V AC, 60V DC per Pole

**DOUBLE POLE**

**HSN Code: 8536**

	Rating (A)	Pack	Cat. Nos.	Unit Price (₹)
	80	1/6/90	811552	934
100	1/6/90	811553	934	
125	1/6/90	811554	1008	

**THREE POLE**

**HSN Code: 8536**

	Rating (A)	Pack	Cat. Nos.	Unit Price (₹)
	80	1/4/60	811557	1414
100	1/4/60	811558	1414	
125	1/4/60	811559	1550	

**FOUR POLE**

**HSN Code: 8536**

	Rating (A)	Pack	Cat. Nos.	Unit Price (₹)
	80	1/3/45	811562	1754
100	1/3/45	811563	1754	
125	1/3/45	811564	1898	

**AUTOMATIC CHANGEOVER WITH CURRENT LIMITER**

- As per IEC60947-6-1
- Intelligent micro controller based Design
- RoHS Compliant

**HSN Code: 8536**

	Rating (A)	Pack	Cat. Nos.	Unit Price (₹)
	SPN 30A Mains 1.5A DG ACCL	1/3/45	810409	2130
	SPN 30A Mains 2.5A DG ACCL	1/3/45	810410	2130
	SPN 30A Mains 3A DG ACCL	1/3/45	810400	2130
	SPN 30A Mains 4A DG ACCL	1/3/45	810401	2130
	SPN 30A Mains 5A DG ACCL	1/3/45	810402	2130
	SPN 30A Mains 6A DG ACCL	1/3/45	810403	2130
	SPN 30A Mains 9A DG ACCL	1/3/45	810404	2130
	SPN 30A Mains 12A DG ACCL	1/3/45	810405	2130
	SPN 30A Mains 15A DG ACCL	1/3/45	810406	2130
	SPN 30A Mains 20A DG ACCL	1/3/45	810407	2130
	SPN 30A Mains 30A DG ACCL	1/3/45	810408	2130

ATTRACTIVE DESIGN  
WITH MINIMAL WALL  
PROJECTION



**Caretron<sup>TM</sup> +**

**DISTRIBUTION BOARDS**

- Degree of Protection  
**IP30** & **IP42**
- Suitable for surface and  
flush mounting



**RoHS  
Compliant**



**Caretron™ + DISTRIBUTION BOARDS**

- Innovative Design with minimal wall projection • Degree of Protection IP 30 AND IP42 • Mechanical Impact Strength IK 08
- Suitable for surface and flush mounting • Detachable Gland Plate • Attractive White Shade (RAL 9010) Matt Finish
- Box Insertion Marks • Circuit Identification Label

**SPN SINGLE DOOR**

**HSN Code: 8537**

	No. of Way	Incomer+ Outgoing	Pack	Cat. Nos.	Unit Price (₹)
	4	4	1/19	810500I	909
	6	6	1/18	810501I	1009
	8	8	1/13	810502I	1148
	12	12	1/11	810503I	1566
	16	16	1/9	810504I	1898

**SPN DOUBLE DOOR**

**HSN Code: 8537**

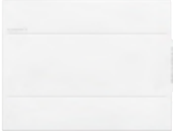
	No. of Way	Incomer+ Outgoing	Pack	Cat. Nos.	Unit Price (₹)
	4	4	1/15	810505	1592
	6	6	1/12	810506	1777
	8	8	1/9	810507	1970
	12	12	1/9	810508	2440
	16	16	1/6	810509	3004

**SPN ACRYLIC**

**HSN Code: 8537**

	No. of Way	Incomer+ Outgoing	Pack	Cat. Nos.	Unit Price (₹)
	4	4	1/12	810567I	1101
	6	6	1/12	810568I	1280
	8	8	1/8	810569I	1512
	10	10	1/8	810570I	1670
	12	12	1/8	810571I	1844
16	16	1/6	810572I	2863	

**TPN SINGLE DOOR**

**HSN Code: 8537**

	No. of Way	Incomer+ Outgoing	Pack	Cat. Nos.	Unit Price (₹)
	4	4 + 12	1/8	810510I	2767
	4	8 + 12	1/5	810511I	3131
	6	4 + 18	1/5	810512I	3328
	6	8 + 18	1/5	810513I	3913
	8	8 + 24	1/4	810514I	4464
12	8 + 36	1/4	810515I	6015	

**TPN DOUBLE DOOR**

**HSN Code: 8537**

	No. of Way	Incomer+ Outgoing	Pack	Cat. Nos.	Unit Price (₹)
	4	4 + 12	1/6	810516	3868
	4	8 + 12	1/4	810517	4018
	6	4 + 18	1/4	810518	4498
	6	8 + 18	1/3	810519	4798
	8	8 + 24	1/3	810520	5945
12	8 + 36	1/3	810521	6737	

**Caretron™ + DISTRIBUTION BOARDS**

- Innovative Design with minimal wall projection • Degree of Protection IP 30 AND IP42 • Mechanical Impact Strength IK 08
- Suitable for surface and flush mounting • Detachable Gland Plate • Attractive White Shade (RAL 9010) Matt Finish
- Box Insertion Marks • Circuit Identification Label

**VTPN MCB INCOMER DOUBLE DOOR**

**HSN Code: 8537**

	No. of Way	Incomer+ Outgoing	Pack	Cat. Nos.	Unit Price (₹)
	4	8 + 12	1	810526	9635
	6	8 + 18	1	810527	11290
	8	8 + 24	1	810528	12577
	12	8 + 36	1	810529	16622

**VTPN 125A MCCB I/C DD DB**

**HSN Code: 8537**

	No. of Way	Incomer+ Outgoing	Pack	Cat. Nos.	Unit Price (₹)
	4	Optium F1 + 12	1	810530	10844
	6	Optium F1 + 18	1	810531	11908
	8	Optium F1 + 24	1	810532	12527
	12	Optium F1 + 36	1	810533	15692

**VTPN 250A MCCB I/C DD DB**

**HSN Code: 8537**

	No. of Way	Incomer+ Outgoing	Pack	Cat. Nos.	Unit Price (₹)
	4	Optium F2 + 12	1	810534	14033
	6	Optium F2 + 18	1	810535	15415
	8	Optium F2 + 24	1	810536	16212
	12	Optium F2 + 36	1	810537	20310

**PHASE SELECTOR 40A DOUBLE DOOR (PRE FITTED SELECTOR SWITCHES)**

**HSN Code: 8536**

	No. of Way	Incomer+ Outgoing	Pack	Cat. Nos.	Unit Price (₹)
	4	8 + 12	1	810546	10572
	6	8 + 18	1	810547	11888
	8	8 + 24	1	810548	12468
	12	8 + 36	1	810549	14258

**PHASE SELECTOR 63A DOUBLE DOOR (PRE FITTED SELECTOR SWITCHES)**

**HSN Code: 8536**

	No. of Way	Incomer+ Outgoing	Pack	Cat. Nos.	Unit Price (₹)
	4	8 + 12	1	810550	13030
	6	8 + 18	1	810551	13648
	8	8 + 24	1	810552	14256
	12	8 + 36	1	810553	16660

**PLUG & SOCKET BOX**

**HSN Code: 8536**

	No. of Way	Incomer+ Outgoing	Pack	Cat. Nos.	Unit Price (₹)
	20A TP (compatible with 20A TP 'C' MCB) Metal Box	3	1/8	810556I	2486
	32A TP (compatible with 32A TP 'C' MCB) Metal Box	3	1/8	810557I	3462
	20A SP (supplied with 20A SP 'C' MCB) Plastic Box	1	1/24	810558I	1147
	20A DP (supplied with 20A DP 'C' MCB) Plastic Box	2	1/24	810559I	1528

**METAL ENCLOSURE**

**HSN Code: 8537**

	No. of Way	Incomer+ Outgoing	Pack	Cat. Nos.	Unit Price (₹)
	1	1	1/50	810560I	452
	2	2	1/36	810561I	452
	3	3	1/36	810562I	528
	4	4	1/32	810563I	528
	6	6	1/24	810564I	614

**PLASTIC ENCLOSURE**

**HSN Code: 8536**

	No. of Way	Incomer+ Outgoing	Pack	Cat. Nos.	Unit Price (₹)
	1 & 2	1/2	1/5/45	810565	106
	3 & 4	3/4	1/3/27	810566	167

**BUSBAR CHAMBER  
TPN BBC (Cu-Busbar)**

**HSN Code: 8536**

	Solution for safe Power Distribution • Step type design • Available in both SPN & TPN configuration	Item Description	Ingress Protection*	Cat Ref.	Unit Price* (₹)
		Spl. 32A TPN BBC (Cu) with 4 o/g ways	IP42	CPPI1015	8074
		Spl. 63A TPN BBC (Cu) with 4 o/g ways	IP42	CPPI1016	9006
		Spl. 100A TPN BBC (Cu) with 4 o/g ways	IP42	CPPI1017	9978
		Spl. 200A TPN BBC (Cu) with 4 o/g ways	IP42	CPPI1018	12342
		Spl. 250A TPN BBC (Cu) with 4 o/g ways	IP42	CPPI1019	17566
		Spl. 320A TPN BBC (Cu) with 4 o/g ways	IP42	CPPI1020	21342
		Spl. 400A TPN BBC (Cu) with 4 o/g ways	IP42	CPPI1021	23714
		Spl. 630A TPN BBC (Cu) with 4 o/g ways	IP42	CPPI1022	37936

\*Also available in IP54 design

**BUSBAR CHAMBER  
TPN-Type (Al.Busbar)**

**HSN Code: 8536**

	Solution for safe Power Distribution • Step type design • Available in both SPN & TPN configuration	Item Description	Ingress Protection*	Cat Ref.	Unit Price* (₹)
		Spl. 32A TPN BBC (Al.) with 4 o/g ways	IP42	CPPI1023	7590
		Spl. 63A TPN BBC (Al.) with 4 o/g ways	IP42	CPPI1024	8074
		Spl. 100A TPN BBC (Al.) with 4 o/g ways	IP42	CPPI1025	8520
		Spl. 200A TPN BBC (Al.) with 4 o/g ways	IP42	CPPI1026	9006
		Spl. 250A TPN BBC (Al.) with 4 o/g ways	IP42	CPPI1027	10886
		Spl. 320A TPN BBC (Al.) with 4 o/g ways	IP42	CPPI1028	11856
		Spl. 400A TPN BBC (Al.) with 4 o/g ways	IP42	CPPI1029	12342
		Spl. 630A TPN BBC (Al.) with 4 o/g ways	IP42	CPPI1008	21212

\*Also available in IP54 design

**MCCB ENCLOSURE**

**HSN Code: 8537**

- Solid Neutral Link for 3 Pole MCCBs

	Description	Pack	Cat. Nos.	Unit Price (₹)
	Optipro Enclosure for Frame-1 Optium 3 Pole MCCB	1	811984	1940
	Optipro Enclosure for Frame-1 Optium 4 Pole MCCB	1	811985	1940
	Optipro Enclosure for Frame-2 Optium 3 Pole MCCB	1	811986	3006
	Optipro Enclosure for Frame-2 Optium 4 Pole MCCB	1	811987	3006
	Optipro Enclosure for Frame-3 Optium 3 Pole MCCB	1	811988	3006
	Optipro Enclosure for Frame-3 Optium 4 Pole MCCB	1	811989	3006
	Optipro Enclosure for Frame-4 Optium 3 Pole MCCB	1	811990	7484
	Optipro Enclosure for Frame-4 Optium 4 Pole MCCB	1	811991	7484

**METAL CLAD PLUG & SOCKET  
AC PLUG**

**HSN Code: 8536**

	Rating	Pack	Cat. Nos.	Unit Price (₹)
	10A 2P+E, 230V AC	1/10/100	810385	184
	20A 2P+E, 230V AC	1/10/100	810386	198
	20A 3P+E, 230V / 415V AC	1/10/100	810387	268
	32A 3P+E, 230V / 415V AC	1/10/100	810388	484

**AC SOCKET**

**HSN Code: 8536**

	Rating	Pack	Cat. Nos.	Unit Price (₹)
	10A 2P+E, 230V AC	1/10/100	810389	184
	20A 2P+E, 230V AC	1/10/100	810390	212
	20A 3P+E, 230V / 415V AC	1/10/100	810391	280
	32A 3P+E, 230V / 415V AC	1/10/100	810392	484

**TIME SWITCHES**

**HSN Code: 9107**

	Model Name	Description	Cat Ref.	Unit Price (₹)
	1mod DIN Daily	1P Module, 24 hours program, Programmable every 15 min., backup of 100 hours, current capacity 16A, with 1 changeover (1 CO)	TA916422	3906
	3mod DIN Daily	3P Module, 24 hours program, Programmable every 15 min., backup of 100 hrs., current capacity 16A, with 1 changeover (1 CO)	TA926453	4254
	DIN Type Daily / Weekly with 1 CO	Programmable every 1 min., with backup of 6 years, 28 memory locations, current capacity 16A, weekly program, with 1 changeover (1 CO), Total 28 program	TDA43110	5170

\* For other models of Time Switches please contact nearest Branch Office.

# ENSURING RELIABLE PERFORMANCE AT HIGH AMBIENT & HUMID ENVIRONMENTS.



— **optium**<sup>™</sup> —  
ALL THAT YOU NEED

**MCCB**

- COMPREHENSIVE PROTECTION – PROTECTED NEUTRAL
- ROBUST PERFORMANCE - NO DE-RATING UPTO 50 DEGREE C
- SAFE - HIGH PHASE-PHASE CLEARANCES
- EASY TO MANAGE - ONLY TWO SIZES OF INTERNAL ACCESSORIES
- INTELLIGENT -ALARMS & PRE-ALARMS FOR ELECTRONIC RANGE



—optium™— **OPTIUM 1.0 (FIXED TM MCCB RANGE)**

- Ics =50% Icu as per IEC 60947-II
- Suitable for isolation
- Class II front face
- Fixed Overload & fixed short circuit setting

**HSN Code: 8536**

	Frame	Breaking capacity	Rating	3P	Unit Price (₹)	4P	Unit Price (₹)
		F1	10kA	16	830701	2758	830710
	F1	10kA	25	830702	2758	830711	3348
	F1	10kA	32	830703	2758	830712	3348
	F1	10kA	40	830704	2758	830713	3348
	F1	10kA	50	830705	2758	830714	3348
	F1	10kA	63	830706	2758	830715	3348
	F1	10kA	80	830707	3108	830716	3976
	F1	10kA	100	830708	3122	830717	3996
	F1	10kA	125	830709	4452	830718	5752

**HSN Code: 8536**

	Frame	Breaking capacity	Rating	3P	Unit Price (₹)	4P	Unit Price (₹)
		F1	16kA	16	830001	4592	830015
	F1	16kA	25	830002	4592	830016	5608
	F1	16kA	32	830003	4592	830017	5608
	F1	16kA	40	830004	4592	830018	5608
	F1	16kA	50	830005	4592	830019	5608
	F1	16kA	63	830006	4592	830020	5608
	F1	16kA	80	830007	4822	830021	6208
	F1	16kA	100	830008	4822	830022	6208
	F1	16kA	125	830009	6680	830023	8780

**HSN Code: 8536**

	Frame	Breaking capacity	Rating	3P	Unit Price (₹)	4P	Unit Price (₹)
		F1	25kA	16	830031	5526	830045
	F1	25kA	25	830032	5526	830046	6606
	F1	25kA	32	830033	5526	830047	6606
	F1	25kA	40	830034	5526	830048	6606
	F1	25kA	50	830035	5526	830049	6606
	F1	25kA	63	830036	5526	830050	6606
	F1	25kA	80	830037	5690	830051	6934
	F1	25kA	100	830038	5690	830052	6934
	F1	25kA	125	830039	6852	830053	9120

**HSN Code: 8536**

	Frame	Breaking capacity	Rating	3P	Unit Price (₹)	4P	Unit Price (₹)
		F1	36kA	16	830061	7316	830075
	F1	36kA	25	830062	7316	830076	8366
	F1	36kA	32	830063	7316	830077	8366
	F1	36kA	40	830064	7316	830078	8366
	F1	36kA	50	830065	7316	830079	8366
	F1	36kA	63	830066	7316	830080	8366
	F1	36kA	80	830067	7428	830081	8818
	F1	36kA	100	830068	7428	830082	8818
	F1	36kA	125	830069	10234	830083	10638

—optium™— **OPTIUM 1.0 (FIXED TM MCCB RANGE)**

**HSN Code: 8536**

	Frame	Breaking capacity	Rating	3P	Unit Price (₹)	4P	Unit Price (₹)
	F3	50kA	16	830125	8750	830145	10638
	F3	50kA	25	830126	8750	830146	10638
	F3	50kA	32	830127	8750	830147	10638
	F3	50kA	40	830128	8750	830148	10638
	F3	50kA	50	830129	8750	830149	10638
	F3	50kA	63	830130	8750	830150	10638
	F3	50kA	80	830131	9190	830151	10960
	F3	50kA	100	830132	9190	830152	10960
	F3	50kA	125	830133	10722	830153	13596

**HSN Code: 8536**

	Frame	Breaking capacity	Rating	3P	Unit Price (₹)	4P	Unit Price (₹)
	F2	16kA	160	830090	7202	830095	10450
	F2	16kA	200	830091	9324	830096	12138
	F2	16kA	250	830092	10288	830097	12820
	F2	25kA	160	830100	8526	830105	10724
	F2	25kA	200	830101	11792	830106	14266
	F2	25kA	250	830102	15216	830107	17886
	F2	36kA	160	830110	10740	830115	13162
	F2	36kA	200	830111	13756	830116	17380
F2	36kA	250	830112	17956	830117	23612	

**HSN Code: 8536**

	Frame	Breaking capacity	Rating	3P	Unit Price (₹)	4P	Unit Price (₹)
	F3	50kA	160	830134	11994	830154	16470
	F3	50kA	200	830135	14436	830155	20266
F3	50kA	250	830136	18566	830156	24666	

**HSN Code: 8536**

	Frame	Breaking capacity	Rating	3P	Unit Price (₹)	4P	Unit Price (₹)
	F4	36kA	315	830165	24244	830175	27658
	F4	36kA	400	830166	25622	830176	29228
	F4	36kA	500	830167	28672	830177	33178
F4	36kA	630	830168	30390	830178	34922	

**HSN Code: 8536**

	Frame	Breaking capacity	Rating	3P	Unit Price (₹)	4P	Unit Price (₹)
	F4	50kA	315	830185	24954	830195	29588
	F4	50kA	400	830186	27236	830196	31960
	F4	50kA	500	830187	29614	830197	34348
F4	50kA	630	830188	31392	830198	35592	

**HSN Code: 8536**

	Frame	Breaking capacity	Rating	3P	MRP	4P	MRP
F5	50kA	800	830200	40902	830201	52832	

—optium™— **OPTIUM 1.1 (FIXED TM MCCB RANGE)**

- Ics = 100% Icu as per IEC 60947-II
- Suitable for isolation
- Class II front face
- Fixed Overload & fixed short circuit setting

**HSN Code: 8536**

	Frame	Breaking capacity	Rating	3P	Unit Price (₹)	4P	Unit Price (₹)
		F1	16kA	32	840003	4780	840017
	F1	16kA	40	840004	4780	840018	6272
	F1	16kA	63	840006	4780	840020	6272
	F1	16kA	80	840007	4966	840021	6708
	F1	16kA	100	840008	4966	840022	6708
	F1	16kA	125	840009	6966	840023	9362
	F1	25kA	32	840033	5798	840047	7344
	F1	25kA	40	840034	5798	840048	7344
	F1	25kA	63	840036	5798	840050	7344
	F1	25kA	80	840037	6144	840051	7488
	F1	25kA	100	840038	6144	840052	7488
	F1	25kA	125	840039	7108	840053	10504
	F2	16kA	160	840090	7614	840095	11352
	F2	16kA	200	840091	9560	840096	12690
	F2	16kA	250	840092	10894	840097	14544
	F2	25kA	160	840100	8864	840105	11712
	F2	25kA	200	840101	12436	840106	14946
	F2	25kA	250	840102	16078	840107	20092

—optium™— **OPTIUM 2.0 (ADJUSTABLE THERMAL SETTING MCCB)**

- Conforms to IEC 60947-II
- Adjustable Overload Setting  $I_r = (0.8 \text{ to } 1.0) \times I_n$
- Ics = 100% Icu
- Class II front face
- Short Circuit setting fixed
- Suitable for isolation

**HSN Code: 8536**

	Frame	Breaking capacity	Rating	3P	Unit Price (₹)	4P	Unit Price (₹)
		F1	16kA	25	830222	4862	830236
	F1	16kA	32	830223	4862	830237	6494
	F1	16kA	40	830224	4862	830238	6494
	F1	16kA	50	830225	4862	830239	6494
	F1	16kA	63	830226	4862	830240	6494
	F1	16kA	80	830227	5272	830241	6982
	F1	16kA	100	830228	5272	830242	6982
	F1	16kA	125	830229	7198	830243	9730

**HSN Code: 8536**

	Frame	Breaking capacity	Rating	3P	Unit Price (₹)	4P	Unit Price (₹)
		F1	25kA	25	830252	6098	830266
	F1	25kA	32	830253	6098	830267	7678
	F1	25kA	40	830254	6098	830268	7678
	F1	25kA	50	830255	6098	830269	7678
	F1	25kA	63	830256	6098	830270	7678
	F1	25kA	80	830257	6398	830271	8054
	F1	25kA	100	830258	6398	830272	8054
	F1	25kA	125	830259	7404	830273	11020

**HSN Code: 8536**

	Frame	Breaking capacity	Rating	3P	Unit Price (₹)	4P	Unit Price (₹)
		F2	16kA	160	830280	7986	830285
	F2	16kA	200	830281	9952	830286	13176
	F2	16kA	250	830282	11520	830287	15566
	F2	25kA	160	830290	10108	830295	13260
	F2	25kA	200	830291	12938	830296	16692
	F2	25kA	250	830292	17296	830297	21632

—optium™— **OPTIUM 2.0 (ADJUSTABLE TM MCCB RANGE)**

- Ics =100% Icu as per IEC 60947-II
- Adjustable Overload Setting Ir =(0.8 to 1.0)×In
- Class II front face
- Adjustable Short Circuit Setting I<sub>sd</sub> =(5 - 10)×In
- Suitable for isolation

**HSN Code: 8536**

	Frame	Breaking capacity	Rating	3P		4P	
				Unit Price (₹)		Unit Price (₹)	
	F3	36kA	16	830305	8156	830325	11270
	F3	36kA	25	830306	8156	830326	11270
	F3	36kA	32	830307	8156	830327	11270
	F3	36kA	40	830308	8156	830328	11270
	F3	36kA	50	830309	8156	830329	11270
	F3	36kA	63	830310	8156	830330	11270
	F3	36kA	80	830311	8317	830331	11602
	F3	36kA	100	830312	8317	830332	11602
	F3	36kA	125	830313	10782	830333	13000

**HSN Code: 8536**

	Frame	Breaking capacity	Rating	3P		4P	
				Unit Price (₹)		Unit Price (₹)	
	F3	50kA	16	830345	10982	830365	13126
	F3	50kA	25	830346	10982	830366	13126
	F3	50kA	32	830347	10982	830367	13126
	F3	50kA	40	830348	10982	830368	13126
	F3	50kA	50	830349	10982	830369	13126
	F3	50kA	63	830350	10982	830370	13126
	F3	50kA	80	830351	11204	830371	13258
	F3	50kA	100	830352	11204	830372	13258
	F3	50kA	125	830353	12326	830373	15826

**HSN Code: 8536**

	Frame	Breaking capacity	Rating	3P		4P	
				Unit Price (₹)		Unit Price (₹)	
	F3	36kA	160	830314	13626	830334	16214
	F3	36kA	200	830315	15280	830335	21156
	F3	36kA	250	830316	20072	830336	27706

**HSN Code: 8536**

	Frame	Breaking capacity	Rating	3P		4P	
				Unit Price (₹)		Unit Price (₹)	
	F3	50kA	160	830354	14122	830374	17810
	F3	50kA	200	830355	16476	830375	22588
	F3	50kA	250	830356	23386	830376	29178

**HSN Code: 8536**

	Frame	Breaking capacity	Rating	3P		4P	
				Unit Price (₹)		Unit Price (₹)	
	F4	25kA	315	830385	21342	830387	26880
	F4	25kA	400	830386	21852	830388	29326
	F4	36kA	315	830390	25648	830395	31238
	F4	36kA	400	830391	27286	830396	33634
	F4	36kA	500	830392	32114	830397	39432
	F4	36kA	630	830393	34550	830398	44170
	F4	50kA	315	830400	27386	830405	33828
	F4	50kA	400	830401	29228	830406	35520
	F4	50kA	500	830402	33480	830407	41646
	F4	50kA	630	830403	36196	830408	46202

—optium™— **OPTIUM 2.0 (ADJUSTABLE TM MCCB RANGE)**

**HSN Code: 8536**

Frame	Breaking capacity	Rating	3P	Unit Price (₹)	4P	Unit Price (₹)
F5	36kA	800	830410	42212	830413	51762
F5	36kA	1000	830411	60794	830414	69540
F5	36kA	1250	830412	70312	830415	83564
F5	50kA	800	830416	43456	830419	61914
F5	50kA	1000	830417	75576	830420	81044
F5	50kA	1250	830418	83354	830421	93870

—optium™— **ACCESSORIES**

**HSN Code: 8538**

Product	Frame	Cat Ref.	Unit Price (₹)
Auxiliary contact	F1 F2 F3	830691	1118
Alarm Contact	F1 F2 F3	830692	1118
Auxiliary contact / Alarm Contact	F4-F5	830693	1466
Auxiliary contact / Alarm Contact	F1 F2 F3	830694	1674

**HSN Code: 8538**

Product	Frame	Cat Ref.	Unit Price (₹)
"Shunt trip 24 V AC/DC"	F1 F2 F3	830602	1266
"Shunt trip 110 V AC/DC"	F1 F2 F3	830603	1266
"Shunt trip 230 V AC/DC"	F1 F2 F3	830604	1354
"Shunt trip 415 V AC/DC"	F1 F2 F3	830605	1354
"Shunt trip 24 V AC/DC"	F4 F5	830642	2488
"Shunt trip 110 V AC/DC"	F4 F5	830643	2488
"Shunt trip 230 V AC/DC"	F4 F5	830644	2488
"Shunt trip 415 V AC/DC"	F4 F5	830645	2488

**HSN Code: 8538**

Product	Frame	Cat Ref.	Unit Price (₹)
"Undervoltage 24 V DC"	F1 F2 F3	830606	2076
"Undervoltage 110V AC"	F1 F2 F3	830607	2076
"Undervoltage 230V AC"	F1 F2 F3	830608	2076
"Undervoltage 415V AC"	F1 F2 F3	830609	2076
"Undervoltage 24 V DC"	F4 F5	830646	2210
"Undervoltage 110V AC"	F4 F5	830647	2210
"Undervoltage 230V AC"	F4 F5	830648	2210
"Undervoltage 415V AC"	F4 F5	830649	2210

**HSN Code: 8538**

Product	Frame	Cat Ref.	Unit Price (₹)
Rotary Handle Direct	F1	830611	1590
Rotary Handle vary-Depth	F1	830612	1590
Rotary Handle Direct	F2 F3	830626	1868
Rotary Handle vary-Depth	F2 F3	830627	1868
Rotary Handle Direct	F4	830651	2210
Rotary Handle vary-Depth	F4	830652	2210
Rotary Handle Direct	F5	830671	4330
Rotary Handle vary-Depth	F5	830672	4330

—optium™— **ACCESSORIES**

**HSN Code: 8538**



Product	Frame	Cat Ref.	Unit Price (₹)
Ronis lock Direct RH	F1 F2 F3	830613	1740
Ronis lock Vary-Depth RH	F1 F2 F3	830614	1740
Ronis lock Vary-Depth RH	F4	830653	2350

**HSN Code: 8538**



Product	Frame	Cat Ref.	Unit Price (₹)
Padlock Off position	F1 F2 F3	830615	2372
Padlock Off position	F4	830654	2372
Padlock Off position	F5	830674	2372

**HSN Code: 8538**



Product	Frame	Cat Ref.	Unit Price (₹)
Phase insulators 3P	F1 F2	830616	POR
Phase insulators 3P	F3	830628	POR
Phase insulators 3P	F4	830655	POR
Phase insulators 3P	F5	830675	POR
Phase insulators 4P	F1 F2	830617	POR
Phase insulators 4P	F3	830629	POR
Phase insulators 4P	F4	830656	POR
Phase insulators 4P	F5	830676	POR

\*\* POR - Price on Request.

**HSN Code: 8538**

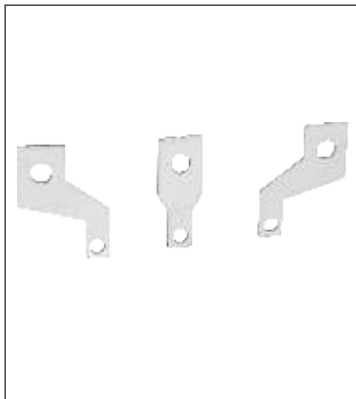

Product	Frame	Cat Ref.	Unit Price (₹)
Spreaders 3P	F1	830618	430
Spreaders 4P	F1	830619	628
Spreaders 3P	F2 F3	830632	1112
Spreaders 4P	F2 F3	830633	2222
Spreaders 3P	F4	830659	3522
Spreaders 4P	F4	830660	5136
Spreaders 3P 800/1000A	F5	830681	9096
Spreaders 4P 800/1000A	F5	830682	13802
Spreaders 3P 1250A	F5	830685	9460
Spreaders 4P 1250A	F5	830686	13944

# SWITCH ON TO NEW RANGE OF EFFICIENT

## SWITCH DISCONNECTOR AND TRANSFER SWITCHING EQUIPMENT





**Modular** 32, 40, 63A



**SD** **TSE**

**Panel Mounted** Frame 1- 100, 125, 160A Frame 2- 200, 250, 320A



**SD** **TSE**



# APPLICATIONS



## Features

1. Quick and Easy Installation
2. Operational Voltage upto 550 V
3. High short time withstand upto 12.5kA for 1 sec
4. High Mechanical and Electrical endurance
5. Extra safety with add on accessories





# UNCOMPROMISED SAFETY WITH ADD ON ACCESSORIES



## DIN FRAME



Direct Handle



Insulated Shorting Links



Auxillary Contact



Vari Depth Rotary Handle



## POWER FRAME



Inter Source Barrier



Phase Barrier



Spreader



Auxillary Contact



Vari Depth Rotary Handle

— optinova™ —

Switch Disconnecter



Transfer Switching Equipment



				Din Frame			Power Frame-1				Power Frame-2			
Performance				IndoAsian OptiNova-SD										
General	Frame	Ith	A	63			160				320			
	Rated currents			32	40	63	63	100	125	160	200	250	320	
	Poles				4			4				4		
Electrical	Rated insulation voltage	Ui	V	690			1000				1000			
	Rated Impulse Withstand Voltage	Uimp	kV	8			8				12			
	Rated frequency				50/60			50/60				50/60		
	Short time withstand current @ rated time(s)			t(s)	lcw for 1s	1.5kA			4kA		5kA		10kA	

— optinova™ —

**4P SWITCH DISCONNECTOR / TRANSFER SWITCHING EQUIPMENT - DIN FRAME HSN Code: 8536**

Rated Current	Switch Disconnecter		Transfer Switching Equipment TSE (On Load ChangeOver)	
	Cat Ref.	Unit Price (₹)	Cat Ref.	Unit Price (₹)
	32A	824006	2164	824106
40A	824007	2286	824107	4430
63A	824008	2708	824108	4944

— optinova™ —

**4P SWITCH DISCONNECTOR / TRANSFER SWITCHING EQUIPMENT - POWER FRAME HSN Code: 8536**

Rated Current	Switch Disconnecter		Transfer Switching Equipment TSE (On Load ChangeOver)		Transfer Switching Equipment TSE (On Load ChangeOver) with Enclosure	
	Cat Ref.	Unit Price (₹)	Cat Ref.	Unit Price (₹)	Cat Ref.	Unit Price (₹)
63A	824082	3672	824182	5764	824192	8384
100A	824083	5120	824183	7172	824193	10962
125A	824084	5532	824184	10758	824194	15402
160A	824085	7010	824185	11992	824195	16932
200A	824086	8772	824186	14332	824196	19686
250A	824087	11016	824187	20502	824197	26214
320A	824088	12228	824188	21832	824198	28254

— optinova™ —

**ACCESSORIES - DIN FRAME HSN Code: 8538**

Product	Cat Ref.	Unit Price (₹)
Shorting links 63A for TSE	824201	754
Auxiliary contact Simultaneous (1 NO + 1 NC)	824208	398
Handle Vary Depth KIT IP54	824209	1112
SD Direct Handle	824215	888
TSE Direct Handle	824217	888

— optinova™ —

**ACCESSORIES - POWER FRAME HSN Code: 8538**

Product	Frame 1- 160A		Frame 2- 320A	
	Cat Ref.	Unit Price (₹)	Cat Ref.	Unit Price (₹)
Aux contact Simultaneous (4 NO + 4 NC)	824245	1112	824245	1112
Shorting Link for TSE	824249	2132	824241	3192
Phase Barriers	824251	174	824243	224
Inter source barrier for TSE	824252	224	824239	358
Spreader terminals (one side only)	824254	868	824238	1734
Handle Direct	824230	928	824230	928
Handle Vary Depth	824231	1326	824231	1326

**HRC FUSE LINKS & BASES**

**BOLTED TYPE (BS) BREAKING CAPACITY ≥ 80kA 500 V AC 50 Hz.**

**HSN Code: 8536**

Rating	Type	Cat Ref.	Tag Type	Unit Price (₹)	
				Unit Price (₹)	Unit/Carton
2, 4, 6, 8, 10, 16A	FGN	IEFGN***	Offset	92	20
20, 25, 32A	FGN	IEFGN***	Offset	102	20
2, 4, 6, 10, 16, 20, 25, 32A	FSA	IEFSA***	Offset	136	10
35, 40, 50, 63A	FSS	IEFSS***	Offset	154	10
50, 63, 80, 100, 125, 160A	FSDCP	IEDCP***	Offset	326	10
100, 125, 160, 200, 250A	FSFP	IESFP***	Offset	468	3
50, 63, 80, 100, 125A	FSDC	IESDC***	Central	326	10
100, 125, 160, 200, 250A	FSF	IEFSF***	Central	478	3
225, 250, 300, 315, 320A	FSK	IEFSK***	Central	692	3
355, 400A	FMF	IEFMF***	Central	1336	3
355, 400, 450, 500, 560, 600, 630A	FTS	IEFTS***	Central	1542	1
355, 400, 450, 500, 560A	FTM	IEFTM***	2 Central	1990	1
600, 630A	FTM	IEFTM***	2 Central	2736	1

**DIN TYPE BREAKING CAPACITY ≥ 80kA 500 V AC 50 Hz.**

**HSN Code: 8536**

Rating Amps	Type	Cat Ref.	Unit Price (₹)	Unit/Carton
2, 4, 6, 10, 16, 20, 25, 32, 50, 63A	Size 000	IWS00***	408	6
2, 4, 6, 10, 16, 20, 25, 32, 36, 40, 50, 63A	Size 00	IW000***	434	6
80, 100A		IW000***	452	6
125, 160A		IW000***	480	6
32, 36, 50, 63, 80, 100, 125, 160, 200A	Size 01	IW001***	794	3
250A		IW001***	904	3
100, 125, 160, 200, 250, 315A	Size 02	IW002***	1164	3
400A		IW002***	1260	3
315, 355, 400, 425A	Size 03	IW003***	1600	3
500, 630A		IW003***	1860	3

\* Note HRC fuses with SC breaking capacity 120kA are available on request.

**CYLINDRICAL TYPE (IFRH) BREAKING CAPACITY > 80kA 415 V AC.**

**HSN Code: 8536**

Rating	Cat Ref.	Unit Price (₹)
2 to 25A	IFRHO***	172
32 to 40A	IFRHO***	180
50A	IFRH0050	334
63A	IFRH0063	344
Fuse Holder Fr type (2 to 63A)	IFR00***	322

**FUSE FITTINGS FOR BOLTED (BS) TYPE**

**HSN Code: 8536**

Rating	Front Connection	Unit Price (₹)	Back Busbar Connection	Unit Price (₹)	Unit/Carton
20A	BFFC 0020	194	BFBC 0020	210	10
32A	BFFC 0032	342	BFBC 0032	354	10
63A	BFFC 0063	492	BFBC 0063	518	5
100A	BFFC 0100	1264	BFBC 0100	1302	3
20A (Stud Type)			BFFCS 020	282	1

**FUSE BASES FOR DIN TYPE HRC FUSE LINKS**

**HSN Code: 8536**

Rating Amps	Suitable for	Cat Ref.	Unit Price (₹)	Unit/Carton
6-160A	Size - 00	IWFB0***	558	6
32-250A	Size - 1	IWFB1***	1062	2
100-400A	Size - 2	IWFB2***	1588	2
315-630A	Size - 3	IWFB3***	2014	2

**SWITCH DISCONNECTOR FUSES**

**HSN Code: 8536**

Rated Current	Type	IN OPEN EXECUTION*		IN SHEET STEEL ENCLOSURE		Recommended HRC Fuse Indo Asian Make
		Cat Ref.	Unit Price (₹)	Cat Ref.	Unit Price (₹)	
32A BS	TPN	INO1A032	2096	INS1A032	4276	FSA
63A BS	TPN	INO1A063	2900	INS1A063	5448	FSS
100A BS	TPN	INO1A100	6374	INS1A100	8916	FSDCP
125A BS	TPN	INO1A125	7152	INS1A125	10686	FSDCP
160A BS	TPN	INO1A160	8656	INS1A160	11932	FSDCP
200A BS	TPN	INO1A200	10772	INS1A200	13880	FSF
250A BS	TPN	INO1A250	12158	INS1A250	16048	FSF
315A BS	TPN	INO1A315	15580	INS1A315	20036	FSK
400A BS	TPN	INO1A400	19338	INS1A400	23916	FMF
32A BS	TPSN	INO1B032	2664	INS1B032	4510	FSA
63A BS	TPSN	INO1B063	3382	INS1B063	5336	FSS
100A BS	TPSN	INO1B100	7836	INS1B100	9984	FSDCP
125A BS	TPSN	INO1B125	8582	INS1B125	10686	FSDCP
160A BS	TPSN	INO1B160	10734	INS1B160	13810	FSDCP
200A BS	TPSN	INO1B200	12226	INS1B200	15282	FSF
250A BS	TPSN	INO1B250	13330	INS1B250	17158	FSF
315A BS	TPSN	INO1B315	18862	INS1B315	23966	FSK
400A BS	TPSN	INO1B400	22314	INS1B400	24928	FMF

\* Price Does Not Include HRC Fuse

**HSN Code: 8536**

Rated Current	Type	IN OPEN EXECUTION*		IN SHEET STEEL ENCLOSURE		Recommended HRC Fuse Indo Asian Make
		Cat Ref.	Unit Price (₹)	Cat Ref.	Unit Price (₹)	
32A DIN	TPN	IN1OA032	2202	IN1SA032	4070	Size 000
63A DIN	TPN	IN1OA063	3054	IN1SA063	5172	Size 000
100A DIN	TPN	IN1OA100	6534	IN1SA100	8818	Size 00
125A DIN	TPN	IN1OA125	7464	IN1SA125	10656	Size 00
160A DIN	TPN	IN1OA160	8982	IN1SA160	11706	Size 00
200A DIN	TPN	IN1OA200	11216	IN1SA200	13324	Size 01
250A DIN	TPN	IN1OA250	12564	IN1SA250	16038	Size 01
315A DIN	TPN	IN1OA315	16140	IN1SA315	19964	Size 02
400A DIN	TPN	IN1OA400	19896	IN1SA400	23664	Size 02
630A DIN	TPN	IN1OA630	31338	IN1SA630	33750	Size 03
800A DIN	TPN	IN1OA800	38210	IN1SA800	47776	Size 03
32A DIN	TPSN	IN1OB032	3120	IN1SB032	4188	Size 000
63A DIN	TPSN	IN1OB063	3598	IN1SB063	4522	Size 000
100A DIN	TPSN	IN1OB100	8060	IN1SB100	9020	Size 00
125A DIN	TPSN	IN1OB125	8932	IN1SB125	9710	Size 00
160A DIN	TPSN	IN1OB160	10466	IN1SB160	12982	Size 00
200A DIN	TPSN	IN1OB200	12162	IN1SB200	13694	Size 01
250A DIN	TPSN	IN1OB250	13928	IN1SB250	15688	Size 01
315A DIN	TPSN	IN1OB315	18642	IN1SB315	21348	Size 02
400A DIN	TPSN	IN1OB400	21666	IN1SB400	26656	Size 02
630A DIN	TPSN	IN1OB630	34782	IN1SB630	36460	Size 03
800A DIN	TPSN	IN1OB800	40218	IN1SB800	52522	Size 03

\* Price Does Not Include HRC Fuse

**SWITCH DISCONNECTOR 4 POLE**

**HSN Code: 8536**

Rated Current	IN OPEN EXECUTION*		IN SHEET STEEL ENCLOSURE	
	Cat Ref.	Unit Price (₹)	Cat Ref.	Unit Price (₹)
400A	IN1SD400	15856	IN3ED400	25080
630A	IN1SD630	22004	IN4ED630	36588
800A	IN1SD800	26206	IN4ED800	42380

\*Prices of 3 Pole SD is available on Request.

**Ambidex CHANGEOVER SWITCHES  
ON-LOAD CHANGEOVER SWITCHES 4 POLE**

**HSN Code: 8536**

Rated Current	IN OPEN EXECUTION		IN SHEET STEEL ENCLOSURE	
	Cat Ref.	Unit Price (₹)	Cat Ref.	Unit Price (₹)
400A	ICAE0400	34340	ICAS0400	53944
630A	ICAE0630	40454	ICAS0630	57806
800A	ITAE0800	56694	ITAS0800	85098
1000A	ITAE1000	102558	ITAS1000	142624
1250A	ITAE1250	137638	ITAS1250	196900
1600A	ITAE1600	158046	ITAS1600	261262
2000A	ITAE2000	231116	ITAS2000	321902
2500A	ITAE2500	317966	ITAS2500	426984
3150A	ITAE3150	326784	ITAS3150	554292

**HSN Code: 8536**

ACCESSORIES FOR AMBIDEX CHANGEOVER SWITCHES	Cat Ref.	Unit Price (₹)
Auxiliary Switch 200A-630A (1NO + 1NC)	ICA00AUX	236
Spreader Links for Frame00 - 1 set (4 links)	ICA00SPL	372

**ON-LOAD SWITCH FUSE CHANGEOVER**

**HSN Code: 8536**

Rated Current	IN OPEN EXECUTION		IN SHEET STEEL ENCLOSURE		Recommended HRC Fuse Indo Asian Make
	Cat Ref.	Unit Price (₹)	Cat Ref.	Unit Price (₹)	
125A	ITBE0125	16014	ITBS0125	24472	FSDCP
200A	ITBE0200	29258	ITBS0200	43438	FSF
250A	ITBE0250	29534	ITBS0250	43842	FSK
320A	ITBE0320	30490	ITBS0320	45268	FSK
400A	ITBE0400	44162	ITBS0400	65566	FTS
630A	ITBE0630	51542	ITBS0630	76524	FTS

Price does not include HRC Fuses.

**ON-LOAD BY-PASS SWITCHES**

**HSN Code: 8536**

Rated Current	IN OPEN EXECUTION		IN SHEET STEEL ENCLOSURE	
	Cat Ref.	Unit Price (₹)	Cat Ref.	Unit Price (₹)
125A	ITCE0125	22782	ITCS0125	30760
200A	ITCE0200	29008	ITCS0200	39162
250A	ITCE0250	42142	ITCS0250	56890
320A	ITCE0320	43758	ITCS0320	59074
400A	ITCE0400	65636	ITCS0400	88610
630A	ITCE0630	74568	ITCS0630	100672

**OFF LOAD CHANGEOVER SWITCH**

**HSN Code: 8536**

 <ul style="list-style-type: none"> <li>• With enclosure</li> <li>• Rated Voltage - 415V-AC 50Hz</li> <li>• Type - FP</li> </ul>	Rating	Cat Ref.	Unit Price (₹)
	32A (DP)	OFDP0032	2064
	16A	OFFP0016	3306
	32A	OFFP0032	3450
	63A	OFFP0063	7012
	100A	OFFP0100	13704
	125A	OFFP0125	19264
	200A	OFFP0200	20798
	250A	OFFP0250	26494
	315A	OFFP0315	27350
	400A	OFFP0400	31906

Prices for spares of Rewirable Switch Fuse Unit like Action Bar, Base Plate, End Shield, Bakelite Contact Shrouds are available on request.

# Quality That's Built Into The Design



## Shynora

SWITCH & SOCKET



5 COLOUR  
FINISHES



HIGH-GRADE  
POLYCARBONATE



ROHS  
COMPLIANT



FIRE  
RETARDANT



ISI MARK



CRS  
CERTIFIED

# Shynora

## WHITE MECHANISMS

SWITCHES: • Polycarbonate Material\* • LED Based Indicator • Shrouded Terminal • ISI Marked

### SWITCHES 6A 230 V AC

HSN Code: 8536

	Cat. Nos.	Description	Module	Unit Price (₹)	Pack
	810600	6A 1 Way Switch	1	44	1/20/400
	810610	6A 2 Way Switch	1	88	1/20/200
	810602	6A 1 Way Switch with Indicator	1	90	1/20/200
	810604	6A 1 Way Switch with "Light" Marking	1	90	1/20/200
	810605	6A 1Way Switch with "Fan" Marking	1	90	1/20/200

### SWITCHES 10A 230 V AC

HSN Code: 8536

	Cat. Nos.	Description	Module	Unit Price (₹)	Pack
	810673	10A 1 Way Switch	1	46	1/20/200
	810674	10A 2 Way Switch	1	92	1/20/200
	810675	10A 1 Way Switch with Indicator	1	92	1/20/200

### SWITCHES 16A 230 V AC

HSN Code: 8536

	Cat. Nos.	Description	Module	Unit Price (₹)	Pack
	810601	16A 1 Way Switch	1	108	1/20/200
	810611	16A 2 Way Switch	1	148	1/10/100
	810603	16A 1 Way Switch with Indicator	1	132	1/20/200

### SWITCHES 20A 230 V AC

HSN Code: 8536

	Cat. Nos.	Description	Module	Unit Price (₹)	Pack
	810606	20A 1 Way Switch	1	146	1/20/200
	810607	20A 1 Way Switch with Indicator	1	170	1/20/200
	810609	20A SP 1 Way Switch	2	210	1/10/100
	810612	20A DP Switch with Indicator	2	190	1/10/100

### SWITCHES 25A 230 V AC

HSN Code: 8536

	Cat. Nos.	Description	Module	Unit Price (₹)	Pack
	810608	25A 1 Way Switch with Indicator	1	198	1/20/200

### SWITCHES 32A 230 V AC

HSN Code: 8536

	Cat. Nos.	Description	Module	Unit Price (₹)	Pack
	810613	32A DP Switch with Indicator	2	260	1/10/100

### BELL PUSH BUTTON 6A 230 V AC

HSN Code: 8536

	Cat. Nos.	Description	Module	Unit Price (₹)	Pack
	810615	6A Bell Push Switch	1	94	1/20/200
	810616	6A Bell Push Switch with Indicator	1	98	1/20/200
	810617	6A Bell Push Switch with Indicator	2	150	1/10/100

### ACCESSORIES FOR SWITCHES

HSN Code: 8536

	Cat. Nos.	Description	Module	Unit Price (₹)	Pack
	810650	LED Indicator for Switches (Red)	-	36	1/5/25



## Shynora

**SOCKET 240 V AC** • Child Safety Shutter • Shrouded Terminals • Smooth Plug removal & insertion

**HSN Code: 8536**

	Cat. Nos.	Description	Module	Unit Price (₹)	Pack
	810620	6A 3 Pin Round Socket with Shutter (ISI mark)	2	110	1/20/200
	810621	6A/16A 3 Pin Socket with Shutter (ISI Mark)	2	212	1/10/100
	810624	25A 3 Pin Socket with Shutter	2	222	1/10/50

**DIMMERS AND FAN REGULATORS** • Laser Marking

**HSN Code: 8538 & 8414**

	Cat. Nos.	Description	Module	Unit Price (₹)	Pack
	810641	Light Dimmer -400W	1	392	1/10/100
	810642	Light Dimmer -500W	2	506	1/10/100
	810638	Fan 4 Step Regulator 100W (ISI mark)	1	368	1/10/100
	810639	Fan Step Regulator 360 deg 100W (ISI mark)	2	484	1/10/100
	810640	Fan 8 step Regulator 100W	2	566	1/10/100

**SKIRTING LIGHT**

**HSN Code: 9405**

	Cat. Nos.	Description	Module	Unit Price (₹)	Pack
	810649	Skirting Light	2	376	1/5/50

**INDICATOR**

**HSN Code: 8536**

	Cat. Nos.	Description	Module	Unit Price (₹)	Pack
	810645	Flat Indicator Red	1	114	1/20/200

**BELL CALL INDICATOR**

**HSN Code: 8536**

	Cat. Nos.	Description	Module	Unit Price (₹)	Pack
	810644	Bell Call Indicator	1	646	1/20/100

**BUZZER**

**HSN Code: 8536**

	Cat. Nos.	Description	Module	Unit Price (₹)	Pack
	810637	Buzzer -230V	1	274	1/20/100

**HOSPITALITY FUNCTION  
HOTEL KEYCARD SWITCH**

**HSN Code: 8538**

	Cat. Nos.	Description	Module	Unit Price (₹)	Pack
	810614	32A DP Keytag Switch (Mechanical)	2	440	1/10
	810646	Key Card SW 16A + Key Fob	2	2,272	1/1/10

## Shynora

### HOSPITALITY FUNCTION

#### HOTEL "DND AND MMR"

HSN Code: 8538

	Cat. Nos.	Description	Module	Unit Price (₹)	Pack
	810647	DND Internal Unit	2	306	1/10/100
	810648	DND External Unit	2	360	1/10/100

#### SHAVER SOCKET

HSN Code: 8538

	Cat. Nos.	Description	Module	Unit Price (₹)	Pack
	810666	Shaver Socket	4	4,006	1/5/20

### SOCKETS AND CONNECTORS

#### TV SOCKETS

HSN Code: 8536

	Cat. Nos.	Description	Module	Unit Price (₹)	Pack
	810633	TV Socket	1	102	1/20/200

#### DATA & VOICE

HSN Code: 8536

	Cat. Nos.	Description	Module	Unit Price (₹)	Pack
	810631	Telephone Socket - RJ11 with Shutter	1	100	1/20/200
	810632	Computer Socket- RJ45 Cat 6 with Shutter	1	590	1/20/200

#### SOUND - ELECTRONIC BELL

HSN Code: 8536

	Cat. Nos.	Description	Module	Unit Price (₹)	Pack
	810643	Electronic Bell	2	264	1/10/100

### PROTECTORS AND ACCESSORIES

#### MOTOR STARTER

HSN Code: 8536

	Cat. Nos.	Description	Module	Unit Price (₹)	Pack
	810664	16A Motor Starter	2	524	10/50
	810665	25A Motor Starter	2	524	10/50

#### MODULAR MCB (IS : 608981:2002) • ISI Mark

HSN Code: 8536

	Cat. Nos.	Description	Module	Unit Price (₹)	Pack
	810654	6A Mini MCB SP C Curve	1	398	1/1/100
	810655	10A Mini MCB SP C Curve	1	398	1/1/100
	810656	16A Mini MCB SP C Curve	1	398	1/1/100
	810657	20A Mini MCB SP C Curve	1	398	1/1/100
	810658	25A Mini MCB SP C Curve	1	398	1/1/100
	810659	32A Mini MCB SP C Curve	1	398	1/1/100
	810660	16A Mini MCB DP C Curve	2	706	1/1/100
	810661	20A Mini MCB DP C Curve	2	706	1/1/100
	810662	25A Mini MCB DP C Curve	2	706	1/1/100
	810663	32A Mini MCB DP C Curve	2	706	1/1/100

# EFFORTLESS CHARGING, SIMPLIFIED LIVING



**Shynora**

USB CHARGERS

Experience Simplified Living with Type C and Type A+C USBs

## Shynora

### PROTECTORS AND ACCESSORIES

#### POWER UNIT

HSN Code: 8536

	Cat. Nos.	Description	Module	Unit Price (₹)	Pack
	810625	Power Unit with 20A MCB & 16A Plug	3	946	1/10
	810626	Power Unit with 25A MCB & 16A Plug	3	1,014	1/10

#### ELECTRONIC FUNCTION

#### USB CHARGERS (IS13252 (PART 1) / IEC 60950-1) • CRS Certified

HSN Code: 8536

	Cat. Nos.	Description	Module	Unit Price (₹)	Pack
	810652	USB Charger 1500mA Type A	1	882	1/10/100
	810651	Double USB Charger 3000mA Type A	2	1,412	1/10/100

#### USB CHARGERS (IS13252 (PART 1) / IEC 60950-1) • CRS Certified

HSN Code: 8536

	Cat. Nos.	Description	Module	Unit Price (₹)	Pack
	810670	USB Charger 1500mA Type C	1	996	1/10/100
	810669	Double USB Charger 3000mA Type A + C	2	1,604	1/10/100

#### ACCESSORIES

HSN Code: 8538

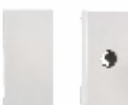
	Cat. Nos.	Description	Module	Unit Price (₹)	Pack
	810667	1 Module Blank Plate	1	26	1/40/400
	810668	Cable Outlet	1	80	1/20/100

## Shynora

### COOL GREY MECHANISMS

SWITCHES: • Polycarbonate Material\* • LED Based Indicator • Shrouded Terminal • ISI Marked



#### SWITCHES 6A 230 V AC

HSN Code: 8536

	Cat. Nos.	Description	Module	Unit Price (₹)	Pack
	810700	6A 1 Way Switch	1	52	1/20/400
	810710	6A 2 Way Switch	1	102	1/20/200
	810702	6A 1 Way Switch with Indicator	1	96	1/20/200
	810704	6A 1 Way Switch with "Light" Marking	1	106	1/20/200
	810705	6A 1 Way Switch with "Fan" Marking	1	106	1/20/200

#### SWITCHES 16A 230 V AC

HSN Code: 8536

	Cat. Nos.	Description	Module	Unit Price (₹)	Pack
	810701	16A 1 Way Switch	1	132	1/20/200
	810711	16A 2 Way Switch* 	1	178	1/10/100
	810703	16A 1 Way Switch with Indicator	1	142	1/20/200

\*Will be available for sale from May 2024 onwards

#### SWITCHES 20A 230 V AC

HSN Code: 8536

	Cat. Nos.	Description	Module	Unit Price (₹)	Pack
	810706	20A 1 Way Switch	1	172	1/20/200
	810707	20A 1 Way Switch with Indicator	1	196	1/20/200
	810709	20A SP 1 Way Switch	2	244	1/10/100
	810712	20A DP Switch with Indicator	2	218	1/10/100

## Shynora

### SWITCHES 25A 230 V AC

HSN Code: 8536

	Cat. Nos.	Description	Module	Unit Price (₹)	Pack
	810708	25A 1 Way Switch with Indicator	1	216	1/20/200

### SWITCHES 32A 230 V AC

HSN Code: 8536

	Cat. Nos.	Description	Module	Unit Price (₹)	Pack
	810713	32A DP Switch with Indicator	2	302	1/10/100

### BELL PUSH BUTTON 6A 230 V AC

HSN Code: 8536

	Cat. Nos.	Description	Module	Unit Price (₹)	Pack
	810715	6A Bell Push Switch	1	108	1/20/200
	810716	6A Bell Push Switch with Indicator	1	118	1/20/200
	810717	6A Bell Push Switch with Indicator	2	174	1/10/100

### SOCKET 240 V AC • Child Safety Shutter • Shrouded Terminals • Smooth Plug removal & insertion

HSN Code: 8536

	Cat. Nos.	Description	Module	Unit Price (₹)	Pack
	810720	6A 3 Pin Round Socket with Shutter (ISI mark)	2	132	1/20/200
	810721	6A/16A 3 Pin Socket with Shutter (ISI Mark)	2	246	1/10/100
	810724	25A 3 Pin Socket with Shutter	2	264	1/10/50

### DIMMERS AND FAN REGULATORS • Laser Marking

HSN Code: 8538 & 8414

	Cat. Nos.	Description	Module	Unit Price (₹)	Pack
	810741	Light Dimmer -400W	1	450	1/10/100
	810742	Light Dimmer -500W	2	592	1/10/100
	810738	Fan 4 Step Regulator 100W (ISI mark)	1	430	1/10/100
	810739	Fan Step Regulator 360 deg 100W (ISI mark)	2	566	1/10/100
	810740	Fan 8 step Regulator 100W	2	710	1/10/100

### SKIRTING LIGHT

HSN Code: 9405

	Cat. Nos.	Description	Module	Unit Price (₹)	Pack
	810749	Skirting Light	2	412	1/5/50

### INDICATOR

HSN Code: 8536

	Cat. Nos.	Description	Module	Unit Price (₹)	Pack
	810745	Flat Indicator Red	1	122	1/20/200

### BUZZER

HSN Code: 8536

	Cat. Nos.	Description	Module	Unit Price (₹)	Pack
	810737	Buzzer -230V	1	318	1/20/100

## Shynora

### HOSPITALITY FUNCTION HOTEL KEYCARD SWITCH

HSN Code: 8538

	Cat. Nos.	Description	Module	Unit Price (₹)	Pack
	810714	32A DP Keytag Switch (Mechanical)	2	510	1/10
	810746	Key Card SW 16A + Key Fob	2	2,850	1/1/10

### HOTEL "DND AND MMR"

HSN Code: 8538

	Cat. Nos.	Description	Module	Unit Price (₹)	Pack
	810747	DND Internal Unit	2	384	1/10/100
	810748	DND External Unit	2	430	1/10/100

### SHAVER SOCKET

HSN Code: 8538

	Cat. Nos.	Description	Module	Unit Price (₹)	Pack
	810766	Shaver Socket	4	5,026	1/5/20

### SOCKETS AND CONNECTORS

#### TV SOCKETS

HSN Code: 8536

	Cat. Nos.	Description	Module	Unit Price (₹)	Pack
	810733	TV socket	1	120	1/20/200

### DATA & VOICE

HSN Code: 8536

	Cat. Nos.	Description	Module	Unit Price (₹)	Pack
	810731	Telephone Socket - RJ11 with Shutter	1	118	1/20/200
	810732	Computer Socket- RJ45 Cat 6 with Shutter	1	686	1/20/200

### PROTECTORS AND ACCESSORIES

#### MOTOR STARTER

HSN Code: 8536

	Cat. Nos.	Description	Module	Unit Price (₹)	Pack
	810764	16A Motor Starter	2	616	10/50
	810765	25A Motor Starter	2	616	10/50

## Shynora

### PROTECTORS AND ACCESSORIES

**MODULAR MCB (IS : 608981:2002) • ISI Mark**

**HSN Code: 8536**

	Cat. Nos.	Description	Module	Unit Price (₹)	Pack
	810754	6A Mini MCB SP C Curve	1	460	1/1/100
	810755	10A Mini MCB SP C Curve	1	460	1/1/100
	810756	16A Mini MCB SP C Curve	1	460	1/1/100
	810757	20A Mini MCB SP C Curve	1	460	1/1/100
	810758	25A Mini MCB SP C Curve	1	460	1/1/100
	810759	32A Mini MCB SP C Curve	1	460	1/1/100

### POWER UNIT

**HSN Code: 8536**

	Cat. Nos.	Description	Module	Unit Price (₹)	Pack
	810725	Power Unit with 20A MCB & 16A Plug	3	1,102	1/10
	810726	Power Unit with 25A MCB & 16A Plug	3	1,184	1/10

### ELECTRONIC FUNCTION

**USB CHARGERS (IS13252 (PART 1) / IEC 60950-1) • CRS Certified**

**HSN Code: 8536**

	Cat. Nos.	Description	Module	Unit Price (₹)	Pack
	810752	USB Charger 1500mA Type A	1	1,104	1/10/100
	810751	Double USB Charger 3000mA Type A	2	1,632	1/10/100

**USB CHARGERS (IS13252 (PART 1) / IEC 60950-1) • CRS Certified**

**HSN Code: 8536**

	Cat. Nos.	Description	Module	Unit Price (₹)	Pack
	810770	USB Charger 1500mA Type C	1	1,132	1/10/100
	810769	Double USB Charger 3000mA Type A + C	2	1,828	1/10/100

### ACCESSORIES

**HSN Code: 8538**

	Cat. Nos.	Description	Module	Unit Price (₹)	Pack
	810767	1 Module Blank Plate	1	32	1/40/400
	810768	Cable Outlet	1	86	1/20/100

**PLATE & FRAME • Strong Dimensional Stability**

**WHITE MODULAR PLATE WITH SUPPORT FRAME**

**HSN Code: 8538**

	Cat. Nos.	Description	Module	Unit Price (₹)	Pack
	810800	White Plate + Frame, 1 module	1	80	1/10/100
	810801	White Plate + Frame, 2 module	2	80	1/10/100
	810802	White Plate + Frame, 3 module	3	122	1/10/100
	810803	White Plate + Frame, 4 module	4	130	1/10/100
	810804	White Plate + Frame, 6 module	6	178	1/5/50
	810805	White Plate + Frame, 8 module	8	230	1/5/50
	810806	White Plate + Frame, 2X4 module	8	230	1/5/25
	810807	White Plate + Frame, 9 module	9	258	1/5/50
	810808	White Plate + Frame, 12 module	12	302	1/5/25
	810809	White Plate + Frame, 16 module	16	340	1/5/25
	810810	White Plate + Frame, 18 module	18	408	1/5/25

# Shynora

## COOL GREY MODULAR PLATE WITH SUPPORT FRAME

HSN Code: 8538

	Cat. Nos.	Description	Module	Unit Price (₹)	Pack
	810811	Cool Grey Plate + Frame, 1 module	1	100	1/10/100
	810812	Cool Grey Plate + Frame, 2 module	2	100	1/10/100
	810813	Cool Grey Plate + Frame, 3 module	3	146	1/10/100
	810814	Cool Grey Plate + Frame, 4 module	4	158	1/10/100
	810815	Cool Grey Plate + Frame, 6 module	6	220	1/5/50
	810816	Cool Grey Plate + Frame, 8 module	8	254	1/5/50
	810817	Cool Grey Plate + Frame, 2X4 module	8	260	1/5/25
	810818	Cool Grey Plate + Frame, 9 module	9	314	1/5/50
	810819	Cool Grey Plate + Frame, 12 module	12	368	1/5/25
	810820	Cool Grey Plate + Frame, 16 module	16	414	1/5/25
810821	Cool Grey Plate + Frame, 18 module	18	500	1/5/25	

## CHROME MODULAR PLATE WITH SUPPORT FRAME

HSN Code: 8538

	Cat. Nos.	Description	Module	Unit Price (₹)	Pack
	810833	Chrome Plate + Frame, 1 module	1	92	1/10/100
	810834	Chrome Plate + Frame, 2 module	2	92	1/10/100
	810835	Chrome Plate + Frame, 3 module	3	128	1/10/100
	810836	Chrome Plate + Frame, 4 module	4	148	1/10/100
	810837	Chrome Plate + Frame, 6 module	6	204	1/5/50
	810838	Chrome Plate + Frame, 8 module	8	240	1/5/50
	810839	Chrome Plate + Frame, 2X4 module	8	246	1/5/25
	810840	Chrome Plate + Frame, 9 module	9	296	1/5/50
	810841	Chrome Plate + Frame, 12 module	12	342	1/5/25
	810842	Chrome Plate + Frame, 16 module	16	392	1/5/25
	810843	Chrome Plate + Frame, 18 module	18	468	1/5/25

## PINK MODULAR PLATE WITH SUPPORT FRAME

HSN Code: 8538

	Cat. Nos.	Description	Module	Unit Price (₹)	Pack
	810844	Pink Plate + Frame, 1 module	1	112	1/10/100
	810845	Pink Plate + Frame, 2 module	2	112	1/10/100
	810846	Pink Plate + Frame, 3 module	3	152	1/10/100
	810847	Pink Plate + Frame, 4 module	4	176	1/10/100
	810848	Pink Plate + Frame, 6 module	6	250	1/5/50
	810849	Pink Plate + Frame, 8 module	8	308	1/5/50
	810850	Pink Plate + Frame, 2X4 module	8	308	1/5/25
	810851	Pink Plate + Frame, 9 module	9	362	1/5/50
	810852	Pink Plate + Frame, 12 module	12	416	1/5/25
	810853	Pink Plate + Frame, 16 module	16	522	1/5/25
	810854	Pink Plate + Frame, 18 module	18	566	1/5/25



# Shynora

## MILAN GOLD MODULAR PLATE WITH SUPPORT FRAME

HSN Code: 8538

	Cat. Nos.	Description	Module	Unit Price (₹)	Pack
	810855	Milan Gold Plate + Frame, 1 module	1	112	1/10/100
	810856	Milan Gold Plate + Frame, 2 module	2	112	1/10/100
	810857	Milan Gold Plate + Frame, 3 module	3	152	1/10/100
	810858	Milan Gold Plate + Frame, 4 module	4	176	1/10/100
	810859	Milan Gold Plate + Frame, 6 module	6	250	1/5/50
	810860	Milan Gold Plate + Frame, 8 module	8	308	1/5/50
	810861	Milan Gold Plate + Frame, 2X4 module	8	308	1/5/25
	810862	Milan Gold Plate + Frame, 9 module	9	362	1/5/50
	810863	Milan Gold Plate + Frame, 12 module	12	416	1/5/25
	810864	Milan Gold Plate + Frame, 16 module	16	522	1/5/25
	810865	Milan Gold Plate + Frame, 18 module	18	566	1/5/25

## METAL FLUSH BOX • Made of G.I. Sheet • Earth Terminal for Safety • Provision for Knockouts Available

HSN Code: 8538

	Cat. Nos.	Description	Module	Unit Price (₹)	Pack
	800172	Metal Flush Box, 1/2 Module	1/2	66	40
	800173	Metal Flush Box, 3 Module	3	86	40
	800174	Metal Flush Box, 4 Module	4	100	40
	800176	Metal Flush Box, 6 Module	6	154	20
	800177	Metal Flush Box, 8 Module (vertical)	8	198	20
	800178	Metal Flush Box, 8 Module	8	198	20
	810867	Metal Flush Box, 9 Module	9	234	20
	800175	Metal Flush Box, 12 Module	12	258	10
	800179	Metal Flush Box, 16 Module	16	296	10
	800180	Metal Flush Box, 18 Module	18	324	10

## WHITE SURFACE BOX • Flame Retardant Material • Edge to Edge Fitting with Plate

HSN Code: 8538

	Cat. Nos.	Description	Module	Unit Price (₹)	Pack
	800182	Plastic Surface Box, 1/2 Module	1/2	68	50
	800183	Plastic Surface Box, 3 Module	3	86	35
	800184	Plastic Surface Box, 4 Module	4	98	35
	800186	Plastic Surface Box, 6 Module	6	150	10
	800187	Plastic Surface Box, 8 Module (vertical)	8	204	15
	810866	Plastic Surface Box, 8 Module	8	216	10
	800185	Plastic Surface Box, 12 Module	12	256	10
	800189	Plastic Surface Box, 16 Module	16	298	10
	800190	Metal Surface Box, 18 Module	18	334	10

**Cover Plates - Shynora**

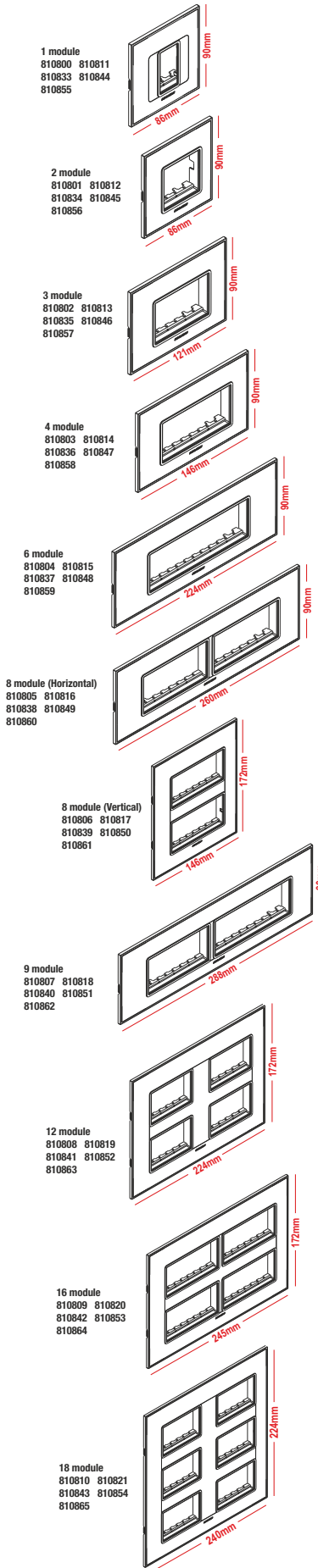

**Flush Boxes-Metal**

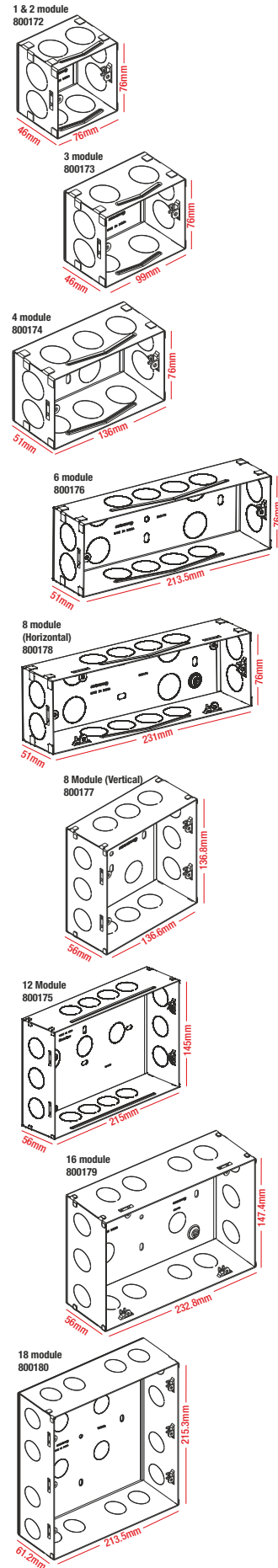

**Surface Boxes-Plastic**

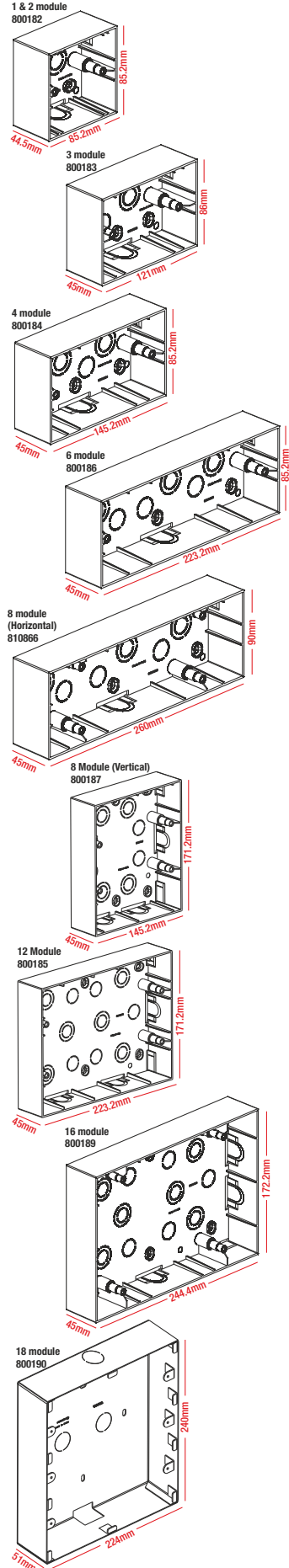

# ADD THE ELEGANCE OF COLOUR TO YOUR SPACE!

WELCOME CHANGE!



**Glint**™  
Welcome Change

**Glint™**  
**WHITE MECHANISMS**

SWITCHES: • Polycarbonate Material\* • LED Based Indicator • ISI Marked

**SWITCHES 6A 230 V AC**

**HSN Code: 8536**

	Cat. Nos.	Description	Module	Unit Price (₹)	Pack
	800000	6A 1 Way Switch	1	34	1/20/400
	800001	6A 2 Way Switch	1	68	1/20/200

**SWITCHES 16A 230 V AC**

**HSN Code: 8536**

	Cat. Nos.	Description	Module	Unit Price (₹)	Pack
	800002	16A 1 Way Switch	1	94	1/20/200
	800003	16A 2 Way Switch	1	118	1/10/100
	800004	16A 1 way Switch with Indicator	1	114	1/10/100

**SWITCHES 20A 230 V AC**

**HSN Code: 8536**

	Cat. Nos.	Description	Module	Unit Price (₹)	Pack
	800005	20A DP Switch with Indicator	2	142	1/10/50

**Switches 25A 230V AC**

**HSN Code: 8536**

	Cat. Nos.	Description	Module	Unit Price (₹)	Pack
	800089	25A Switch with Indicator	1	122	1/10/100

**SWITCHES 32A 230 V AC**

**HSN Code: 8536**

	Cat. Nos.	Description	Module	Unit Price (₹)	Pack
	800006	32A DP Switch with Indicator	2	208	1/10/50

**BELL PUSH BUTTON 6A 230 V AC**

**HSN Code: 8536**

	Cat. Nos.	Description	Module	Unit Price (₹)	Pack
	800007	6A Bell Push with Indicator	1	82	1/10/100
	800008	6A Bell Push with Indicator	2	120	1/10/100

**SOCKET 240 V AC • Child Safety Shutter • Smooth Plug removal & insertion**

**HSN Code: 8536**

	Cat. Nos.	Description	Module	Unit Price (₹)	Pack
	801800	6A 3 Pin Round Socket with Shutter (ISI mark)	2	68	1/20/200
	800022	6A/16A 3 Pin Socket with Shutter (ISI Mark)	2	128	1/10/100



**DIMMERS AND FAN REGULATORS • Laser Marking for Easy Identification**

**HSN Code: 8538 & 8414**

	Cat. Nos.	Description	Module	Unit Price (₹)	Pack
	800042	Light Dimmer -400W	1	314	1/10/100
	800041	Fan 4 Step Regulator -100W	1	322	1/10/100
	800043	Fan 4 Step Regulator -100W	2	362	1/10/100
	800090	Fan 5 Step Regulator -100W ( ISI mark) <b>NEW</b>	2	266	1/10/100
	800091	Fan 8 Step Regulator -100W <b>NEW</b>	2	322	1/10/100

**Glint™**  
**SKIRTING LIGHT**

HSN Code: 8536

 	Cat. Nos.	Description	Module	Unit Price (₹)	Pack
		800092	Skirting Light 2M	2	232

**INDICATOR**

HSN Code: 8536

	Cat. Nos.	Description	Module	Unit Price (₹)	Pack
	800033	Flat Indicator Red	1	92	1/10/100



**BUZZER**

HSN Code: 8536

	Cat. Nos.	Description	Module	Unit Price (₹)	Pack
	800040	Buzzer 230V	1	182	1/20/100



**HOSPITALITY FUNCTION**  
**HOTEL KEYCARD SWITCH**

HSN Code: 8536

 	Cat. Nos.	Description	Module	Unit Price (₹)	Pack
	800093	32A DP Keytag Switch (Mechanical)	2	316	1/10

**HOTEL "DND AND MMR" FUNCTIONS**

HSN Code: 8536

  	Cat. Nos.	Description	Module	Unit Price (₹)	Pack
	800094	DND Internal Unit	2	118	1/10/100
	800095	DND External Unit	2	208	1/10/100

**SOCKETS AND CONNECTORS**



**TV SOCKETS**

HSN Code: 8536

	Cat. Nos.	Description	Module	Unit Price (₹)	Pack
	800032	TV Socket	1	66	1/20/100

**DATA & VOICE**

HSN Code: 8536

 	Cat. Nos.	Description	Module	Unit Price (₹)	Pack
	800030	Telephone Socket - RJ11	1	72	1/20/100
	800031	Computer Socket- RJ45 Cat 6	1	168	1/20/100

**PROTECTORS AND ACCESSORIES**



**MODULAR MCB (IS : 608981:2002) • Laser marking**

HSN Code: 8536

	Cat. Nos.	Description	Module	Unit Price (₹)	Pack
	800097	6A Mini MCB SP C Curve	1	200	1/10/100
	800098	10A Mini MCB SP C Curve	1	200	1/10/100
	800010	16A Mini MCB SP C Curve	1	306	1/10/100
	800011	20A Mini MCB SP C Curve	1	306	1/10/100
	800012	25A Mini MCB SP C Curve	1	306	1/10/100
	800013	32A Mini MCB SP C Curve	1	306	1/10/100

**Glint™**  
**MOTOR STARTER**

HSN Code: 8536

 	Cat. Nos.	Description	Module	Unit Price (₹)	Pack
		800096	25A MOTOR STARTER	2	334

**ELECTRONIC FUNCTION**

**USB CHARGERS (IS13252 (PART 1) / IEC 60950-1) • CRS Certified**

HSN Code: 8536

	Cat. Nos.	Description	Module	Unit Price (₹)	Pack
		800044	USB Charger 1500mA Type A	1	758

**ACCESSORIES • Spare Screw Caps**

HSN Code: 8538

	Cat. Nos.	Description	Module	Unit Price (₹)	Pack
	800051	1 Module Blank Plate	1	22	1/20/200
	800052	2 Module Blank Plate	2	26	1/10/100
	800059	Screw Caps		22	1/10/100

**Glint™**

**WHITE GLINT PLATE**

PLATE: • Unique Design - Sleek & Curvy • Flame Retardant Material • Compatible with Standard Size of Metal Flush & Plastic Surface Boxes

HSN Code: 8538

	Cat. Nos.	Description	Module	Unit Price (₹)	Pack
	800061	1 Module Plate	1	48	1/10/100
	800062	2 Module Plate	2	48	1/10/100
	800063	3 Module Plate	3	70	1/10/100
	800064	4 Module Plate	4	82	1/10/100
	800066	6 Module Plate	6	104	1/5/50
	800067	8 Module Plate (vertical)	8	144	1/5/25
	800068	8 Module Plate (horizontal)	8	136	1/5/50
	800065	12 Module Plate	12	188	1/5/25
	800069	16 Module Plate	16	196	1/5/25
	800070	18 Module Plate	18	238	1/5/25

**WHITE GLINT PLATE WITH FRAME**

PLATE & FRAME: • Aesthetic Design • Suitable for Metal Flush & Wooden Boxes • Comes with Regular & Self Tapping Screws

HSN Code: 8538

	Cat. Nos.	Description	Module	Unit Price (₹)	Pack
	800071	White Plate + Frame, 1M	1	74	1/10/100
	800072	White Plate + Frame, 2M	2	74	1/10/100
	800073	White Plate + Frame, 3M	3	94	1/10/100
	800074	White Plate + Frame, 4M	4	118	1/10/100
	800076	White Plate + Frame, 6M	6	148	1/10/50
	800078	White Plate + Frame, 8M ( Vertical)	8	212	1/5/25
	800079	White Plate + Frame, 8M ( Horizontal)	8	212	1/10/50
	800080	White Plate + Frame, 10M	10	250	1/5/25
	800082	White Plate + Frame, 12M ( Vertical)	12	272	1/5/25
	800084	White Plate + Frame, 12M ( Horizontal)	12	272	1/5/25
	800086	White Plate + Frame, 16M	16	310	1/5/25
	800088	White Plate + Frame, 18M	18	336	1/5/25

**Glint™**

**METALLIC GREY GLINT PLATE WITH FRAME**

**HSN Code: 8538**

	Cat. Nos.	Description	Module	Unit Price (₹)	Pack
	800241	Metallic Grey Plate + Frame, 1M	1	108	1/10/100
	800242	Metallic Grey Plate + Frame, 2M	2	108	1/10/100
	800243	Metallic Grey Plate + Frame, 3M	3	134	1/10/100
	800244	Metallic Grey Plate + Frame, 4M	4	168	1/10/100
	800245	Metallic Grey Plate + Frame, 6M	6	208	1/10/50
	800246	Metallic Grey Plate + Frame, 8M (Horizontal)	8	296	1/5/25
	800247	Metallic Grey Plate + Frame, 8M (Vertical)	8	296	1/10/50
	800248	Metallic Grey Plate + Frame, 10M	10	348	1/5/25
	800249	Metallic Grey Plate + Frame, 12M (Horizontal)	12	380	1/5/25
	800250	Metallic Grey Plate + Frame, 12M (Vertical)	12	380	1/5/25
	800251	Metallic Grey Plate + Frame, 16M	16	504	1/5/25
	800252	Metallic Grey Plate + Frame, 18M	18	536	1/5/25

**METALLIC GOLD GLINT PLATE WITH FRAME**

**HSN Code: 8538**

	Cat. Nos.	Description	Module	Unit Price (₹)	Pack
	800253	Metallic Gold Plate + Frame, 1M	1	108	1/10/100
	800254	Metallic Gold Plate + Frame, 2M	2	108	1/10/100
	800255	Metallic Gold Plate + Frame, 3M	3	134	1/10/100
	800256	Metallic Gold Plate + Frame, 4M	4	168	1/10/100
	800257	Metallic Gold Plate + Frame, 6M	6	208	1/10/50
	800258	Metallic Gold Plate + Frame, 8M (Horizontal)	8	296	1/5/25
	800259	Metallic Gold Plate + Frame, 8M (Vertical)	8	296	1/10/50
	800260	Metallic Gold Plate + Frame, 10M	10	348	1/5/25
	800261	Metallic Gold Plate + Frame, 12M (Horizontal)	12	380	1/5/25
	800262	Metallic Gold Plate + Frame, 12M (Vertical)	12	380	1/5/25
	800263	Metallic Gold Plate + Frame, 16M	16	504	1/5/25
	800264	Metallic Gold Plate + Frame, 18M	18	536	1/5/25

**METALLIC PLUM GLINT PLATE WITH FRAME**

**HSN Code: 8538**

	Cat. Nos.	Description	Module	Unit Price (₹)	Pack
	800265	Metallic Plum Plate + Frame, 1M	1	108	1/10/100
	800266	Metallic Plum Plate + Frame, 2M	2	108	1/10/100
	800267	Metallic Plum Plate + Frame, 3M	3	134	1/10/100
	800268	Metallic Plum Plate + Frame, 4M	4	168	1/10/100
	800269	Metallic Plum Plate + Frame, 6M	6	208	1/10/50
	800270	Metallic Plum Plate + Frame, 8M (Horizontal)	8	296	1/5/25
	800271	Metallic Plum Plate + Frame, 8M (Vertical)	8	296	1/10/50
	800272	Metallic Plum Plate + Frame, 10M	10	348	1/5/25
	800273	Metallic Plum Plate + Frame, 12M (Horizontal)	12	380	1/5/25
	800274	Metallic Plum Plate + Frame, 12M (Vertical)	12	380	1/5/25
	800275	Metallic Plum Plate + Frame, 16M	16	504	1/5/25
	800276	Metallic Plum Plate + Frame, 18M	18	536	1/5/25

**Glint™**

**METALLIC MINT GLINT PLATE WITH FRAME**

**HSN Code: 8538**

	Cat. Nos.	Description	Module	Unit Price (₹)	Pack
	800277	Metallic Mint Plate + Frame, 1M	1	108	1/10/100
	800278	Metallic Mint Plate + Frame, 2M	2	108	1/10/100
	800279	Metallic Mint Plate + Frame, 3M	3	134	1/10/100
	800280	Metallic Mint Plate + Frame, 4M	4	168	1/10/100
	800281	Metallic Mint Plate + Frame, 6M	6	208	1/10/50
	800282	Metallic Mint Plate + Frame, 8M (Horizontal)	8	296	1/5/25
	800283	Metallic Mint Plate + Frame, 8M (Vertical)	8	296	1/10/50
	800284	Metallic Mint Plate + Frame, 10M	10	348	1/5/25
	800285	Metallic Mint Plate + Frame, 12M (Horizontal)	12	380	1/5/25
	800286	Metallic Mint Plate + Frame, 12M (Vertical)	12	380	1/5/25
	800287	Metallic Mint Plate + Frame, 16M	16	504	1/5/25
	800288	Metallic Mint Plate + Frame, 18M	18	536	1/5/25

**METAL FLUSH BOX • Made of G.I. Sheet • Earth Terminal for Safety • Provision for Knockouts Available**

**HSN Code: 8538**

	Cat. Nos.	Description	Module	Unit Price (₹)	Pack
	800172	Metal Flush Box, 1/2 Module	1/2	66	40
	800173	Metal Flush Box, 3 Module	3	86	40
	800174	Metal Flush Box, 4 Module	4	100	40
	800176	Metal Flush Box, 6 Module	6	154	20
	800177	Metal Flush Box, 8 Module (vertical)	8	198	20
	800178	Metal Flush Box, 8 Module	8	198	20
	810867	Metal Flush Box, 9 Module	9	234	20
	800175	Metal Flush Box, 12 Module	12	258	10
	800179	Metal Flush Box, 16 Module	16	296	10
	800180	Metal Flush Box, 18 Module	18	324	10

**WHITE SURFACE BOX • Flame Retardant Material • Edge to Edge Fitting with Plate**

**HSN Code: 8538**

	Cat. Nos.	Description	Module	Unit Price (₹)	Pack
	800182	Plastic Surface Box, 1/2 Module	1/2	68	50
	800183	Plastic Surface Box, 3 Module	3	86	35
	800184	Plastic Surface Box, 4 Module	4	98	35
	800186	Plastic Surface Box, 6 Module	6	150	10
	800187	Plastic Surface Box, 8 Module (vertical)	8	204	15
	800188	Plastic Surface Box, 8 Module	8	204	10
	800185	Plastic Surface Box, 12 Module	12	256	10
	800189	Plastic Surface Box, 16 Module	16	298	10
	800190	Metal Surface Box, 18 Module	18	334	10



**Cover Plates - Glint™**

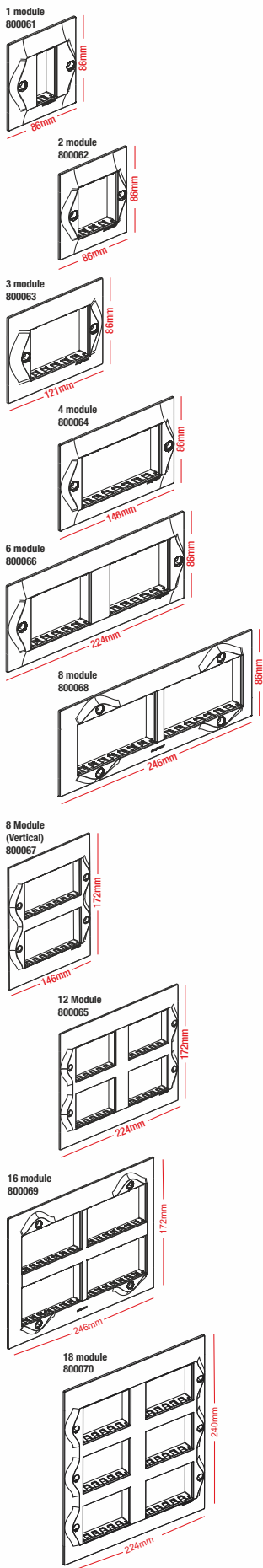

**Flush Boxes-Metal**

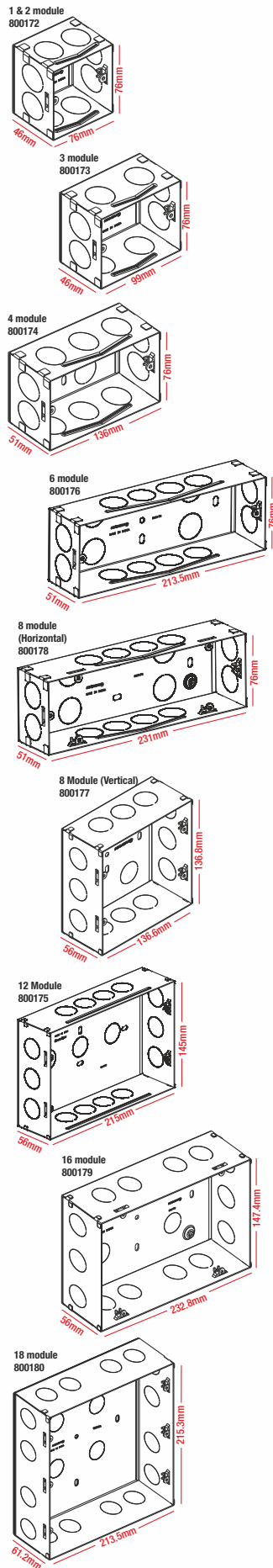

**Surface Boxes-Plastic**

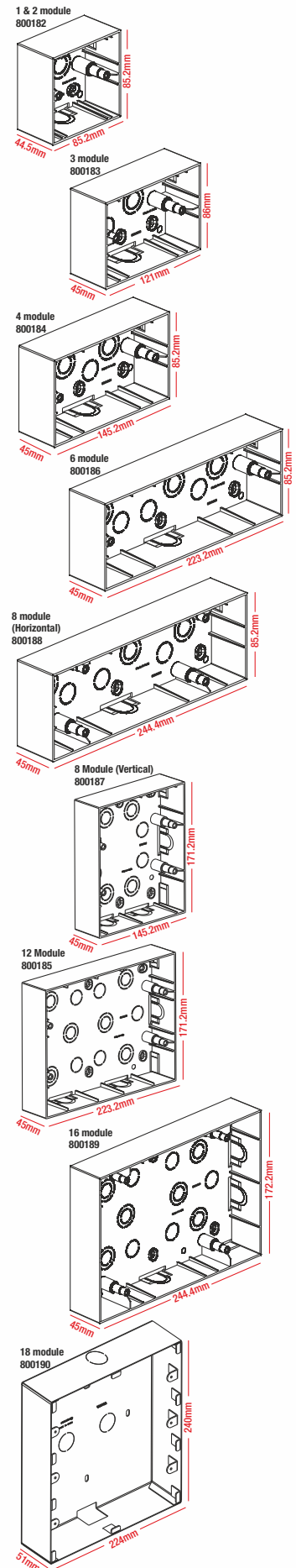

COLOURS THAT REFLECT  
YOUR PERSONALITY.



**ELVIRA**  
A SENSIBLE SWITCH

**ELVIRA**  
A SENSIBLE SWITCH

**WHITE MECHANISMS**

SWITCHES: • Polycarbonate Material\* • LED Based Indicator • ISI Marked

**SWITCHES 6A 230 V AC**

**HSN Code: 8536**

	Cat. Nos.	Description	Module	Unit Price (₹)	Pack
	800100	6A 1 Way Switch	1	38	1/20/400
	800101	6A 2 Way Switch	1	86	1/20/100
	800102	6A 1 Way Switch with Indicator	1	84	1/20/200

**SWITCHES 10A 230 V AC**

**HSN Code: 8536**

	Cat. Nos.	Description	Module	Unit Price (₹)	Pack
	800114	10A 1 Way Switch	1	40	1/20/400
	800115	10A 2 Way Switch	1	88	1/20/100
	800116	10A 1 Way Switch with Indicator	1	86	1/20/200

**SWITCHES 16A 230 V AC**

**HSN Code: 8536**

	Cat. Nos.	Description	Module	Unit Price (₹)	Pack
	800103	16A 1 Way Switch	1	104	1/20/200
	800104	16A 2 Way Switch	1	148	1/10/100
	800105	16A 1 Way Switch with Indicator	1	130	1/20/200

**SWITCHES 20A 230 V AC**

**HSN Code: 8536**

	Cat. Nos.	Description	Module	Unit Price (₹)	Pack
	800107	20A DP Switch with Indicator	2	184	1/10/50

**SWITCHES 25A 230 V AC**

**HSN Code: 8536**

	Cat. Nos.	Description	Module	Unit Price (₹)	Pack
	800106	25A 1 Way Switch with Indicator	1	192	1/10/100

**SWITCHES 32A 230 V AC**

**HSN Code: 8536**

	Cat. Nos.	Description	Module	Unit Price (₹)	Pack
	800108	32A DP Switch with Indicator	2	254	1/10/50

**BELL PUSH BUTTON 6A 230 V AC**

**HSN Code: 8536**

	Cat. Nos.	Description	Module	Unit Price (₹)	Pack
	800110	6A Bell Push with Indicator	1	92	1/20/200
	800111	6A Bell Push with Indicator	2	146	1/10/100

**SOCKET 240 V AC • Child Safety Shutter • Smooth Plug removal & insertion**

**HSN Code: 8536**

	Cat. Nos.	Description	Module	Unit Price (₹)	Pack
	802800	6A 3 Pin Round Socket with Shutter (ISI mark)	2	90	1/20/200
	800122	6A/16A 3 Pin socket with Shutter (ISI Mark)	2	174	1/10/50
	800124	25A 3 Pin Socket with Shutter	2	200	1/10/50

**ELVIRA**  
A SENSIBLE SWITCH

**DIMMERS AND FAN REGULATORS • Laser Marking for Easy Identification**

**HSN Code: 8538 & 8414**

	Cat. Nos.	Description	Module	Unit Price (₹)	Pack
	800143	Light Dimmer 400W	1	372	1/10/100
	800141	Fan 4 Step Regulator 100W (ISI Mark)	1	358	1/10/100
	800142	Fan 4 Step Regulator 100W (ISI Mark)	2	436	1/10/100
	800139	Fan 8 step Regulator 100W	2	536	1/10/100

**SKIRTING LIGHT**

**HSN Code: 8536**

	Cat. Nos.	Description	Module	Unit Price (₹)	Pack
	800155	Skirting Light	2	376	1/5/25

**INDICATOR**

**HSN Code: 8536**

	Cat. Nos.	Description	Module	Unit Price (₹)	Pack
	800154	Flat Indicator Red	1	106	1/20/100

**BUZZER**

**HSN Code: 8536**

	Cat. Nos.	Description	Module	Unit Price (₹)	Pack
	800140	Buzzer 230V	1	266	1/20/100

**BELL CALL INDICATOR**

**HSN Code: 8536**

	Cat. Nos.	Description	Module	Unit Price (₹)	Pack
	800144	Bell Call indicator	1	568	1/20/100

**SOCKETS AND CONNECTORS**

**TV SOCKETS**

**HSN Code: 8536**

	Cat. Nos.	Description	Module	Unit Price (₹)	Pack
	800132	TV Socket	1	92	1/20/100

**DATA & VOICE**

**HSN Code: 8536**

	Cat. Nos.	Description	Module	Unit Price (₹)	Pack
	800130	Telephone Socket - RJ11	1	94	1/20/100
	800131	Computer Socket- RJ45 Cat 6	1	244	1/20/100

**ELVIRA**  
A SENSIBLE SWITCH

**PROTECTORS AND ACCESSORIES**

**MOTOR STARTER**

**HSN Code: 8536**

	Cat. Nos.	Description	Module	Unit Price (₹)	Pack
	800196	25A Motor Starter	2	434	10/50

**MODULAR MCB (IS : 608981:2002) • Laser marking**

**HSN Code: 8536**

	Cat. Nos.	Description	Module	Unit Price (₹)	Pack
	800160	16A Mini MCB SP C Curve	1	386	1/10/100
	800191	20A Mini MCB SP C Curve	1	386	1/10/100
	800156	25A Mini MCB SP C Curve	1	386	1/10/100
	800157	32A Mini MCB SP C Curve	1	386	1/10/100

**PROTECTORS AND ACCESSORIES**

**POWER UNIT**

**HSN Code: 8536**

	Cat. Nos.	Description	Module	Unit Price (₹)	Pack
	800193	Power Unit with 20A MCB & 16A Plug	3	910	1/10
	800194	Power Unit with 25A MCB & 16A Plug	3	978	1/10

**ELECTRONIC FUNCTION**

**USB CHARGERS (IS13252 (PART 1) / IEC 60950-1) • CRS Certified**

**HSN Code: 8536**

	Cat. Nos.	Description	Module	Unit Price (₹)	Pack
	800145	USB charger 1500mA Type A	1	850	1/10/100

**HOSPITALITY FUNCTION**

**HOTEL KEYCARD SWITCH**

**HSN Code: 8538**

	Cat. Nos.	Description	Module	Unit Price (₹)	Pack
	800197	Key card Switch 16A	2	2,172	1/10

**HOTEL "DND AND MMR"**

**HSN Code: 8538**

	Cat. Nos.	Description	Module	Unit Price (₹)	Pack
	800192	DND Internal Unit	2	186	1/10/100
	800195	DND External Unit	2	222	1/10/100

**ACCESSORIES**

**HSN Code: 8538**

	Cat. Nos.	Description	Module	Unit Price (₹)	Pack
	800151	1 Module Blank Plate	1	26	1/20/200
	800152	2 Module Blank Plate	2	44	1/10/100
	800153	Cable Outlet	1	76	1/20/100

**ELVIRA**  
A SENSIBLE SWITCH

**PLATE & FRAME**

**WHITE MODULAR PLATE WITH SUPPORT FRAME • Strong Dimensional Stability**

**HSN Code: 8538**

	Cat. Nos.	Description	Module	Unit Price (₹)	Pack
	800161	White Plate + Frame, 1M	1	78	1/10/100
	800162	White Plate + Frame, 2M	2	78	1/10/100
	800163	White Plate + Frame, 3M	3	106	1/10/100
	800164	White Plate + Frame, 4M	4	122	1/10/100
	800166	White Plate + Frame, 6M	6	156	1/5/50
	800167	White Plate + Frame, 8M( Vertical)	8	218	1/5/25
	800168	White Plate + Frame, 8M( Horizontal)	8	216	1/5/50
	800165	White Plate + Frame, 12M	12	292	1/5/25
	800169	White Plate + Frame, 16M	16	338	1/5/25
	800170	White Plate + Frame, 18M	18	402	1/5/25

**SILVER LIGHT PURPLE MODULAR PLATE WITH SUPPORT FRAME**

**HSN Code: 8538**

	Cat. Nos.	Description	Module	Unit Price (₹)	Pack
	800201	Silver Light Purple Plate + Frame, 1M	1	108	1/10/100
	800202	Silver Light Purple Plate + Frame, 2M	2	108	1/10/100
	800203	Silver Light Purple Plate + Frame, 3M	3	136	1/10/100
	800204	Silver Light Purple Plate + Frame, 4M	4	168	1/10/100
	800205	Silver Light Purple Plate + Frame, 6M	6	224	1/5/50
	800206	Silver Light Purple Plate+Frame, 8M (Horizontal)	8	300	1/5/50
	800207	Silver Light Purple Plate+Frame, 8M (Vertical)	8	300	1/5/25
	800208	Silver Light Purple Plate + Frame, 12M	12	382	1/5/25
	800209	Silver Light Purple Plate + Frame, 16M	16	506	1/5/25
	800210	Silver Light Purple Plate + Frame, 18M	18	542	1/5/25

**INOX SILVER MODULAR PLATE WITH SUPPORT FRAME**

**HSN Code: 8538**

	Cat. Nos.	Description	Module	Unit Price (₹)	Pack
	800211	Inox Silver Plate + Frame, 1M	1	108	1/10/100
	800212	Inox Silver Plate + Frame, 2M	2	108	1/10/100
	800213	Inox Silver Plate + Frame, 3M	3	136	1/10/100
	800214	Inox Silver Plate + Frame, 4M	4	168	1/10/100
	800215	Inox Silver Plate + Frame, 6M	6	224	1/5/50
	800216	Inox Silver Plate + Frame, 8M ( Horizontal)	8	300	1/5/50
	800217	Inox Silver Plate + Frame, 8M ( Vertical)	8	300	1/5/25
	800218	Inox Silver Plate + Frame, 12M	12	382	1/5/25
	800219	Inox Silver Plate + Frame,16M	16	506	1/5/25
	800220	Inox Silver Plate + Frame, 18M	18	542	1/5/25

**ELVIRA**  
A SENSIBLE SWITCH

**POLARIZED GREY MODULAR PLATE WITH SUPPORT FRAME**

HSN Code: 8538

	Cat. Nos.	Description	Module	Unit Price (₹)	Pack
	800221	Polarized Grey Plate + Frame 1M	1	108	1/10/100
	800222	Polarized Grey Plate + Frame 2M	2	108	1/10/100
	800223	Polarized Grey Plate + Frame 3M	3	136	1/10/100
	800224	Polarized Grey Plate + Frame 4M	4	168	1/10/100
	800225	Polarized Grey Plate + Frame 6M	6	224	1/5/50
	800226	Polarized Grey Plate + Frame 8M ( Horizontal)	8	300	1/5/50
	800227	Polarized Grey Plate + Frame 8M ( Vertical)	8	300	1/5/25
	800228	Polarized Grey Plate + Frame 12M	12	382	1/5/25
	800229	Polarized Grey Plate + Frame 16M	16	506	1/5/25
	800230	Polarized Grey Plate + Frame 18M	18	542	1/5/25

**ASH PURPLE MODULAR PLATE WITH SUPPORT FRAME**

HSN Code: 8538

	Cat. Nos.	Description	Module	Unit Price (₹)	Pack
	800231	Ash Purple Plate + Frame, 1M	1	108	1/10/100
	800232	Ash Purple Plate + Frame, 2M	2	108	1/10/100
	800233	Ash Purple Plate + Frame, 3M	3	136	1/10/100
	800234	Ash Purple Plate + Frame, 4M	4	168	1/10/100
	800235	Ash Purple Plate + Frame, 6M	6	224	1/5/50
	800236	Ash Purple Plate + Frame, 8M ( Horizontal)	8	300	1/5/50
	800237	Ash Purple Plate + Frame, 8M ( Vertical)	8	300	1/5/25
	800238	Ash Purple Plate + Frame, 12M	12	382	1/5/25
	800239	Ash Purple Plate + Frame, 16M	16	506	1/5/25
	800240	Ash Purple Plate + Frame, 18M	18	542	1/5/25

**METAL FLUSH BOX • Made of G.I. Sheet • Earth Terminal for Safety • Provision for Knockouts Available**

HSN Code: 8538

	Cat. Nos.	Description	Module	Unit Price (₹)	Pack
	800172	Metal Flush Box, 1/2 Module	1/2	66	40
	800173	Metal Flush Box, 3 Module	3	86	40
	800174	Metal Flush Box, 4 Module	4	100	40
	800176	Metal Flush Box, 6 Module	6	154	20
	800177	Metal Flush Box, 8 Module (vertical)	8	198	20
	800178	Metal Flush Box, 8 Module	8	198	20
	810867	Metal Flush Box, 9 Module	9	234	20
	800175	Metal Flush Box, 12 Module	12	258	10
	800179	Metal Flush Box, 16 Module	16	296	10
	800180	Metal Flush Box, 18 Module	18	324	10

**WHITE SURFACE BOX • Flame Retardant Material • Edge to Edge Fitting with Plate**

HSN Code: 8538

	Cat. Nos.	Description	Module	Unit Price (₹)	Pack
	800182	Plastic Surface Box, 1/2 Module	1/2	68	50
	800183	Plastic Surface Box, 3 Module	3	86	35
	800184	Plastic Surface Box, 4 Module	4	98	35
	800186	Plastic Surface Box, 6 Module	6	150	10
	800187	Plastic Surface Box, 8 Module (vertical)	8	204	15
	800188	Plastic Surface Box, 8 Module	8	204	10
	800185	Plastic Surface Box, 12 Module	12	256	10
	800189	Plastic Surface Box, 16 Module	16	298	10
	800190	Metal Surface Box, 18 Module	18	334	10

**Cover Plates - ELVIRA**  
A SENSIBLE SWITCH

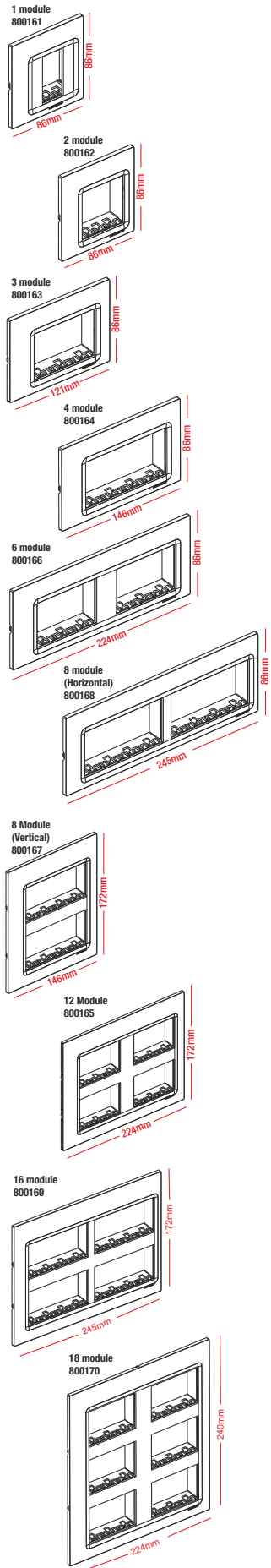

**Flush Boxes-Metal**

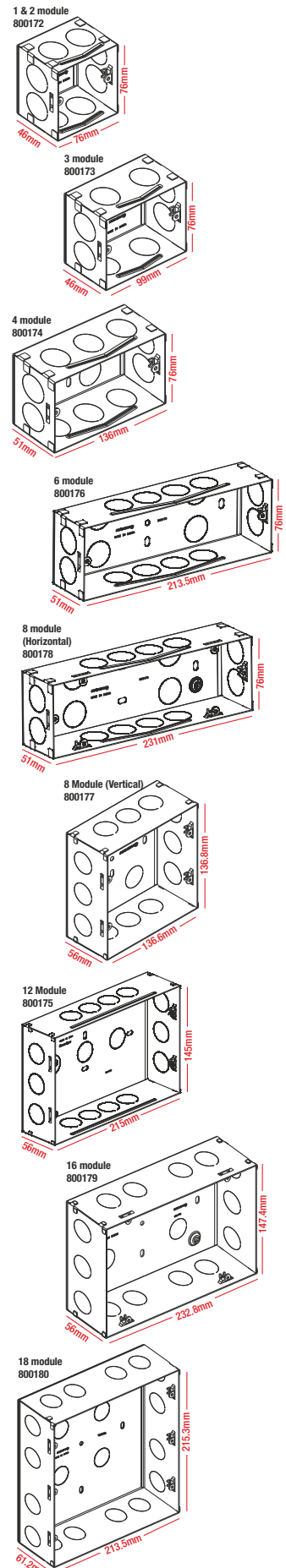

**Surface Boxes-Plastic**

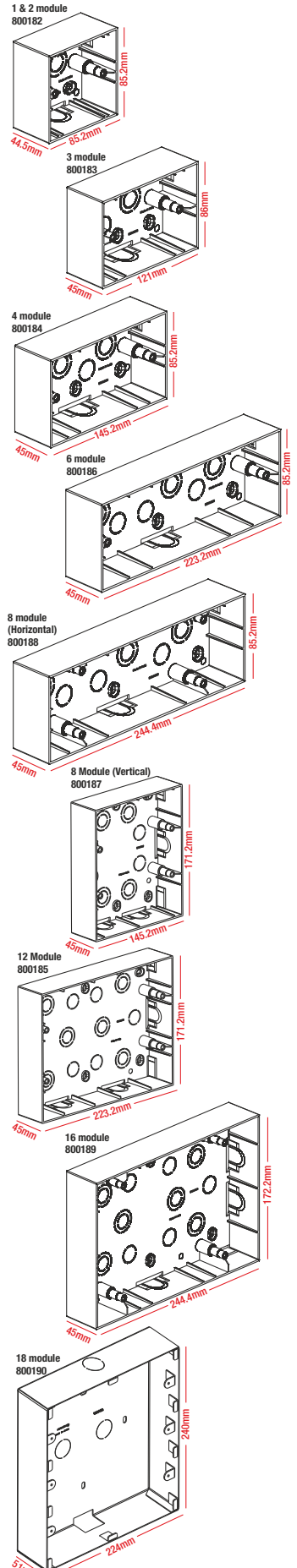



# A POWERFUL EXHAUST FAN

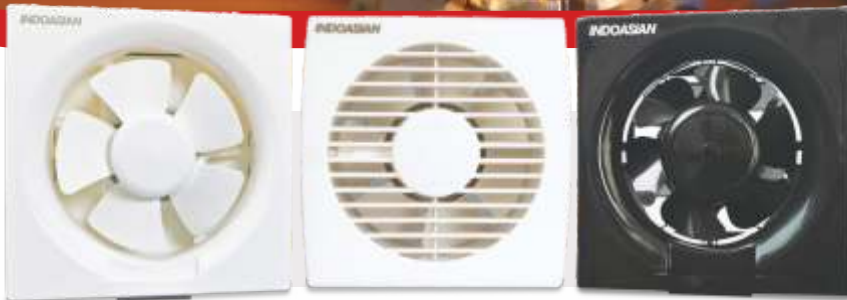

**Zosta**<sup>™</sup>

A RANGE TO MATCH YOUR NEEDS



LOW POWER  
CONSUMPTION



EASY  
INSTALLATION



ROHS  
COMPLIANT

**3 PIN PLUGS WITH EASY GRIP** • White Matt Finish • Tested as per IS 1293

**HSN Code: 8536**

	Cat. Nos.	Description	Unit Price (₹)	Pack
	698470	6A 3 Pin Plug (ISI mark)	92	20/200
	698471	16A 3 Pin Plug (ISI mark)	136	10/100

**FANCY BATTEN BULB HOLDER / CEILING ROSE** • IS Standards • Dynamic Design

**HSN Code: 8536**

	Cat. Nos.	Description	Unit Price (₹)	Pack
	698473	Fancy Batten Bulb Holder White	80	20/200
	698474	Fancy Angle Bulb Holder White	80	20/200
698475	Fancy Ceiling Rose White	52	20/200	

**EXHAUST FAN - WHITE / BLACK** • Copper Motor • RoHS Compliant • Rust Free Body

**HSN Code: 8536**

	Cat. Nos.	Description	Unit Price (₹)	Pack
	698500	Exhaust Fan 150mm White	2080	1/6
	698501	Exhaust Fan 200mm White	2332	1/6
	698502	Exhaust Fan 250mm White	2664	1/6
	698503	Exhaust Fan 150mm Black	2080	1/6
	698504	Exhaust Fan 200mm Black	2332	1/6
698505	Exhaust Fan 250mm Black	2664	1/6	

**AXIAL EXHAUST FAN - WHITE** • Copper Motor • RoHS Compliant • Rust Free Body

**HSN Code: 8536**

	Cat. Nos.	Description	Unit Price (₹)	Pack
	698506	Axial Exhaust Fan 100mm White	1466	1/20
	698507	Axial Exhaust Fan 150mm White	1602	1/20

**BRIGHT IDEAS FOR HAPPY  
& SAFE LIVING!**



## **BULB HOLDER & CEILING ROSE**



Multiple Advantages



RoHS Compliant



Value For Money

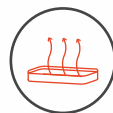

Ducts For Heat  
Dissipation



Long Lasting  
Polycarbonate Plastic



Metal Ring  
Avoid Deformation









## GENERAL TERMS

- This price list supersedes all previous price lists.
- All prices are in Indian Rupees only.
- All prices are Maximum Retail Prices (MRP) inclusive of GST as applicable.
- Our discount structure is exclusive of GST
- Orders will be accepted in multiples of standard packing.
- Prices are subject to change without notice. All despatches will be as per prices prevailing on the date of despatch. Prices are ex-godown, exclusive of packing/forwarding/freight and insurance.
- Product design is subject to change without notice for continuous up gradation.
- Disputes if any are subject to Delhi Jurisdiction only.
- Company reserves the right to issue amendments which may arise due to any printing errors in the price list.

## WARRANTY

IA products carry a warranty against manufacturing defects, subject to use of the product for the right application, with correct wiring/connection and normal operating conditions. Please refer to detailed IndoAsian warranty policy effective 1<sup>st</sup> Jan 2024.

MCBs	36 Months
RCCBs	36 Months
DBs/ACCL	12 Months
HRC Fuses	6 Months
MCCBs/BFF/Fuse Bases/Changeover Switchgears/SDF	12 Months
Time Switches	12 Months
For Wiring Devices - Switches & Socket	120 Months
Bulb Holder/Ceiling Rose	12 Months
For Wiring Devices - Electronic Products (e.g. Fan Regulator, Dimmer, Buzzer, RJ45, RJ11 & TV Sockets, Bell Indicator, Motor starter, Skirting light)	24 Months

## CHANNEL PARTNER

**CORPORATE OFFICE:** V. J. Business Towers, A-6, 1st Floor, Sector-125, Noida-201301, U.P., India. Ph.: +91-0120-3305111 E-mail: customer.care@indoasian.com, international@indoasian.com Website: www.indoasian.com

**CUSTOMER CARE HEAD:** Novateur Electrical & Digital Systems Pvt. Ltd., V. J. Business Towers, A-6, 1st Floor, Sector-125, Noida-201301, U.P., India.  
Ph.: +91-0120-3305100 Toll Free no. 1800 103 7077 E-mail: customer.care@indoasian.com

### NORTH

#### Regional Sales office DELHI NCR

V. J. Business Towers  
A-6, Ground Floor,  
Sector-125, Noida-201303  
Ph.: 0120-6858900

#### Branch office CHANDIGARH

SCO No. 6, 2nd Floor,  
Madhya Marg, Sector 26,  
Chandigarh-160019

#### Branch office JAIPUR

433, 4th Floor, Ganpati Plaza,  
M. I. Road,  
Jaipur-302001  
Ph.: 0141-4113528

#### Branch office LUCKNOW

301, 3rd Floor, Chintel House,  
Station Road,  
Lucknow-226001  
Ph.: 0522-4013210

### SOUTH

#### Regional Sales office BANGALORE

787, 1st Floor "Skyline Vista"  
15th Cross, 100 Feet Ring Road  
J P Nagar 1st Phase  
Bangalore-560 078  
Tel: 080-46219999

#### Branch office COCHIN

Door No.65/1317, Syda Building,  
2nd Floor, Kaloor-Kadavanthra Road,  
Kaloor, Ernakulam District,  
Kochi-682017 (Kerala)  
Ph.: 0484-4055581-88

#### Branch office COIMBATORE

Door No. 83,  
Dr. Nanjappa Road,  
Coimbatore-641018  
Ph.: 0422-2302715

#### Branch office CHENNAI

No.5, 1st Floor, Mahalingapuram Main Road,  
Nungambakkam,  
Chennai-600034  
Ph.: 044-28172096, 28170527

#### Branch office HYDERABAD

312, 3rd Floor,  
Amrutha Estates, Himayath Nagar,  
Hyderabad-500029  
Ph.: 040-66742425

### WEST

#### Regional Sales office MUMBAI

401 & 408, K.P. Arrum,  
Marol Morshi Road, Andheri East,  
Mumbai-400059  
Ph.: 022-61035800

#### Branch office AHMEDABAD

102, 1st Floor, Shivalik High Street,  
Near Mansi Circle, Vastrapur,  
Ahmedabad-380015  
Ph.: 079-29701351-53

#### Branch office INDORE

Tower B, 403 - The One  
Ravindra Nath Tagore Marg,  
Indore- 452001  
Ph.: 0731-4677510

#### Branch office PUNE

311, Pride Silicon Plaza,  
Bhamburda, Shivaji Nagar,  
Senapati Bapat Marg,  
Pune-411016  
Ph.: 8087610722

### EAST

#### Regional Sales office KOLKATA

"Raikva Building" Room No. 8, 2nd Floor,  
3A Ram Mohan Garden Lane,  
Beliaghata E.M.Bypass, Kolkata-700010  
Ph.: 033-66041503

IA/Retail Price List/04-24



# WE SUPPORT

E-mail: customer.care@indoasian.com

