

Switches Sockets and Accessories  
Product Information and Price List



# Company Overview

A Professional of electrical switchgear, Norisys constructs innovative switchgear systems and has established itself by many years of experience and high quality workmanship. Norisys is committed to being recognised as a premier destination for electrical products.

Each day Norisys engineers work to bring about a combination of innovative designs and materials using advanced manufacturing technology in order to create products that are best suited to meet user requirements.

We continuously strive to upgrade processes and materials. CUBE Series and SQUARE Series products thus ensure sound electrical performance.

Products such as Modular MCBs, Single Phase Motor Starters, Power Units for airconditioners are all products made by Norisys, and have today become common household products. Quality is ensured at every stage.



The manufacturing plant is equipped with modern state-of-the-art machinery and equipment. In-house facilities for testing and quality assurance of all components ensure guaranteed quality. Extensive material selection process and rigorous quality monitoring process is followed for conformity to highest standards.



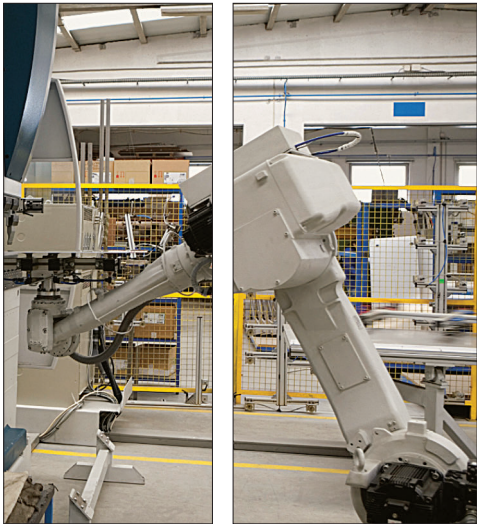

All products from Norisys have been developed to establish new standards in electrical accessories. Commitment to superior designs, elaborate attention to engineering details, modern manufacturing facilities and stringent quality measures have combined together to create a new concept in safety, reliability, flexibility and modernity.

Norisys has a full fledged, well equipped research and development division which works constantly to improve, innovate and engineer new products. This research and development division has a fully integrated product development environment that directs the development process throughout - right from conceptual design to manufacturing.

All Norisys products are designed for extreme endurance. Materials are chosen to withstand arduous conditions. Local wiring practices are carefully studied before designing any new product at Norisys. This ensures ease of installation and durability of the products.

# Bi-material Frames engineered for toughness

CUBE Series products are designed for tough performance. The products are mounted in a way that the entire pressure of wires in the junction box is borne entirely by a sturdy bi-material frame.

by this mechanism and it maintains uniform gaps between the modules. This mechanism uses locks which remain free from any stress after mounting, thus making the system extremely durable with long life.

4

The bi-material support frames in CUBE Series is the result of several man-hours of research and development. The bi-material frames are made of a combination of steel and engineering grade plastic. In this design, the steel structure is embeded into plastic. The steel inside gives the bi-material frame a rigid structure while the plastic provides the anti-rust and insulation properties.

Wiring connections can be made upon fixing the modules on the bi-material frames. Cover plates can be mounted after final painting of walls, thus preventing the plates from getting soiled during construction and painting work.

Modules are mounted on the bi-material frames using a unique snap-fit mechanism. This snap-fit mechanism is highly accurate thereby ensuring that all modules fit comfortably without the need of force. Location of the modules on the bi--material frames is controlled

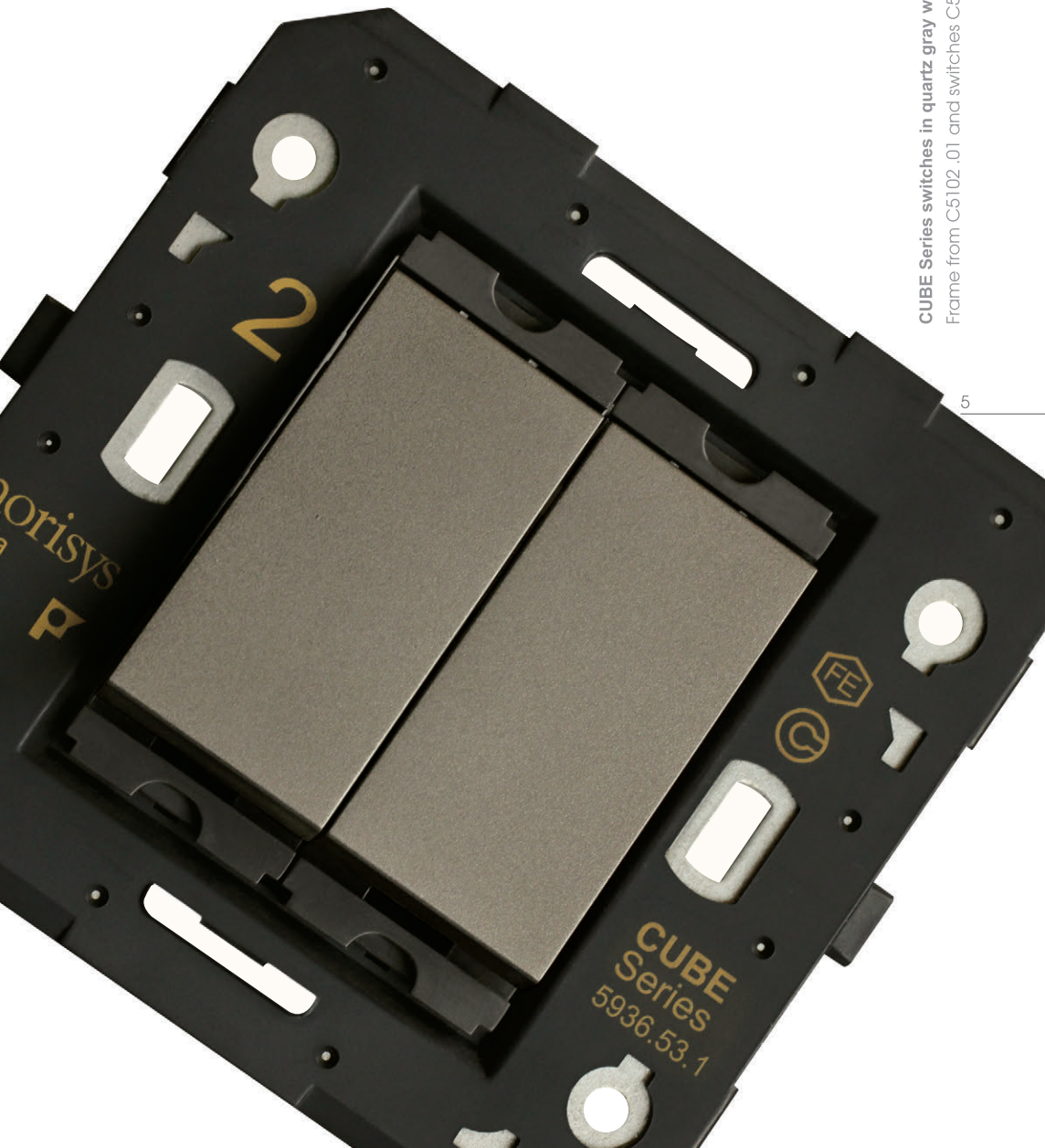

CUBE Series switches in quartz gray with a two module frame  
Frame from C5102.01 and switches C5110.02

# CUBE Series

CUBE Series is a modular product range which is designed to satisfy the requirements of electrical installations in modern buildings.

The range includes switches, sockets, fan regulators & dimmers, hospitality products, communication sockets, acoustic and optical signaling products, cover plates etc.

Modules such as switches, sockets etc. are made to a standard size (module) which are mounted on frames. Front plates are available in a variety of colours, materials and finish. The front plates can be changed at any time without disturbing the wiring to adapt to changes in building interiors.

Use of engineering grade thermoset materials in CUBE Series products makes the range extremely strong and sturdy with flame proof qualities. The engineering grade thermoset material used in the products has

excellent electrical insulation properties and does not catch fire. This ensures that the products are capable of handling higher operating temperatures. This engineering grade thermoset material is conventionally used in industrial applications where high degree of electrical insulation is required.

**CUBE Series quartz gray switches & sockets with solid wood plate**  
Switches C5110.02 Socket C5212.02 and Plate CW304.06

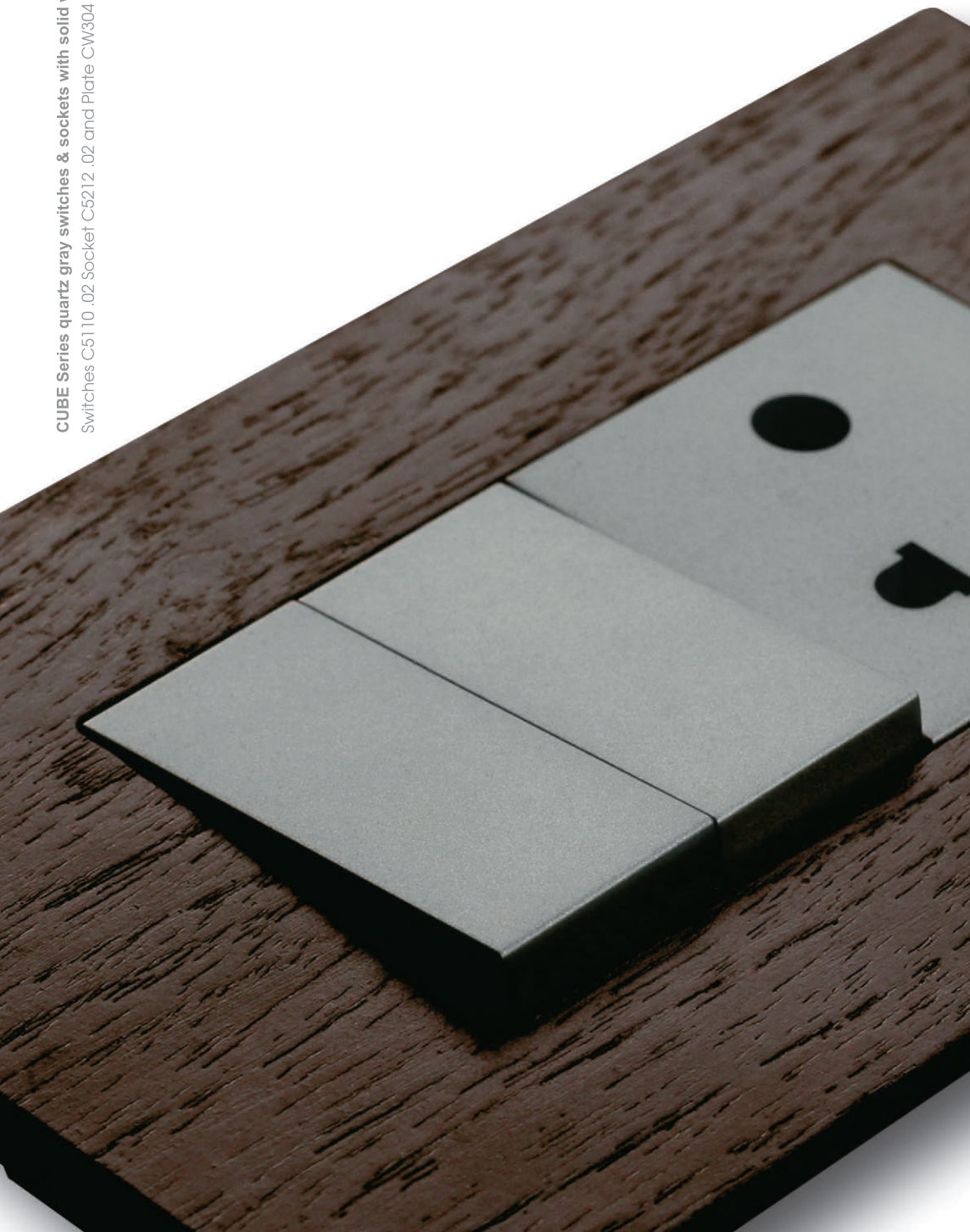



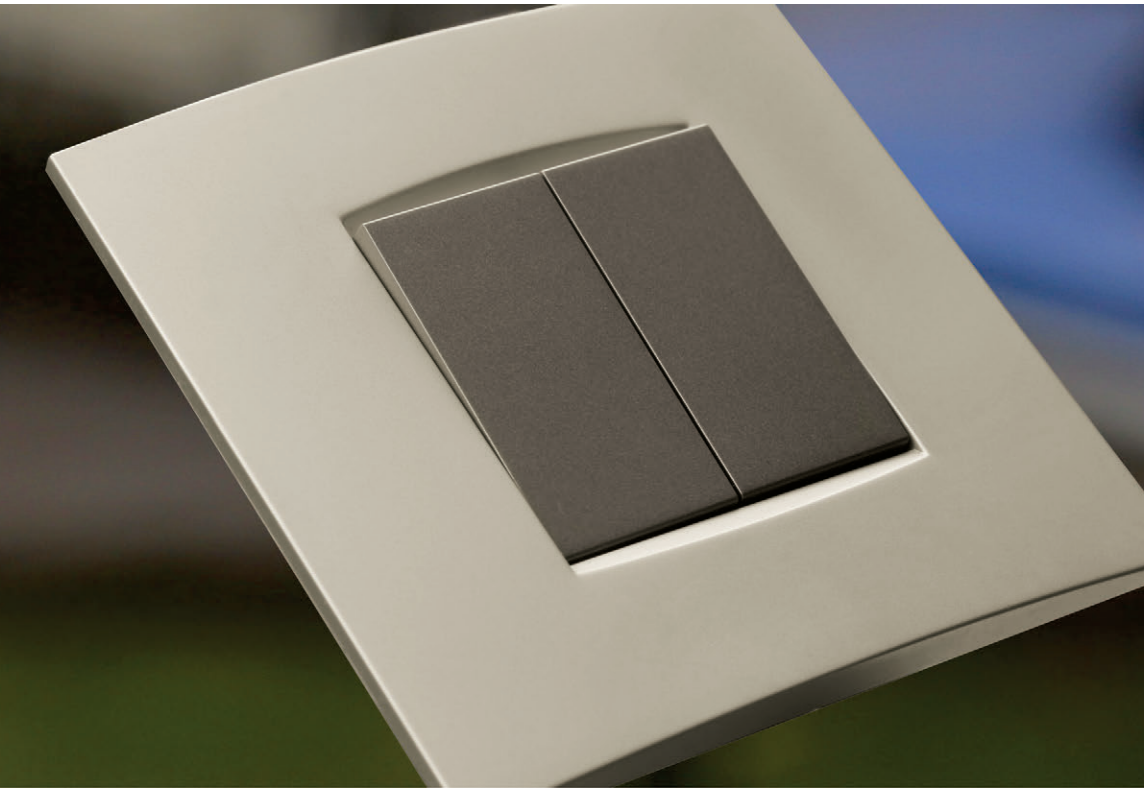

Norisy's engineers have been working day after day with diligence in order to ensure consistent electrical, mechanical and thermal qualities.

# CUBE Series

## the technology inside

CUBE Series switches have contacts which provide very high current carrying capacity. The contact design, snap action mechanism, appropriate contact pressure, wiping action between the contacts and use of high engineering grade materials result in minimum arcing. Reduction in arcing ensures a very long operating life for the switches.

Proper shrouding of terminals and current carrying parts is provided in all switches and sockets. Since the live parts are separated by thermoset material, they are prevented from fusing together in case of any over-heating.

LED indicators used in the CUBE Series switches emit a soft, reassuring glow which is mild and soothing to the eyes. Use of high quality LEDs ensures a long indicator life without flicker.

Norisys engineers developed a unique ring-shaped spring which solves the frequently occurring problem of burnouts in power sockets. Norisys sockets feature this ring-shaped spring which maintains a uniform pressure on the brass contact tubes. This pressure clamps the plug pins tightly leading to a firm spark-free contact, thus eliminating overheating and consequential burnouts.

CUBE Series sockets are child protected. Safety shutters have been put in place to prevent any accidental contact with live parts thereby reducing risk of electric shocks.

# CUBE Series

## tiny mcb - modular mcb system

Tiny MCB is a high performance and a reliable safety device, which has now become a common household product. It is a modular MCB that can be mounted simply like a switch. These MCBs are front mounted along with switches, sockets etc. of CUBE Series or SQUARE Series products. Tiny MCB can also be mounted on sunmica sheets of any existing or new receptacle commonly used in household wiring.

Single Pole and Double Pole versions are available in Tiny MCB in various ratings. Distribution Boards for single phase are made using Tiny MCBs on CUBE Series or SQUARE Series plates or even on sunmica sheets. These distribution boards are compact and smart. When mounted with a 25Ampere socket, it offers the perfect solution for switching airconditioners and geysers.

Tiny MCBs are high performance devices that incorporate advanced developments in electrical engineering technology for protection of circuits and individual appliances. They are typically used for switching and protection of air-conditioners, geysers, pumps, heaters and other appliances that draw high current in domestic applications. These MCBs are also used as a master switch in rooms to switch off the entire circuit in a room for energy saving.



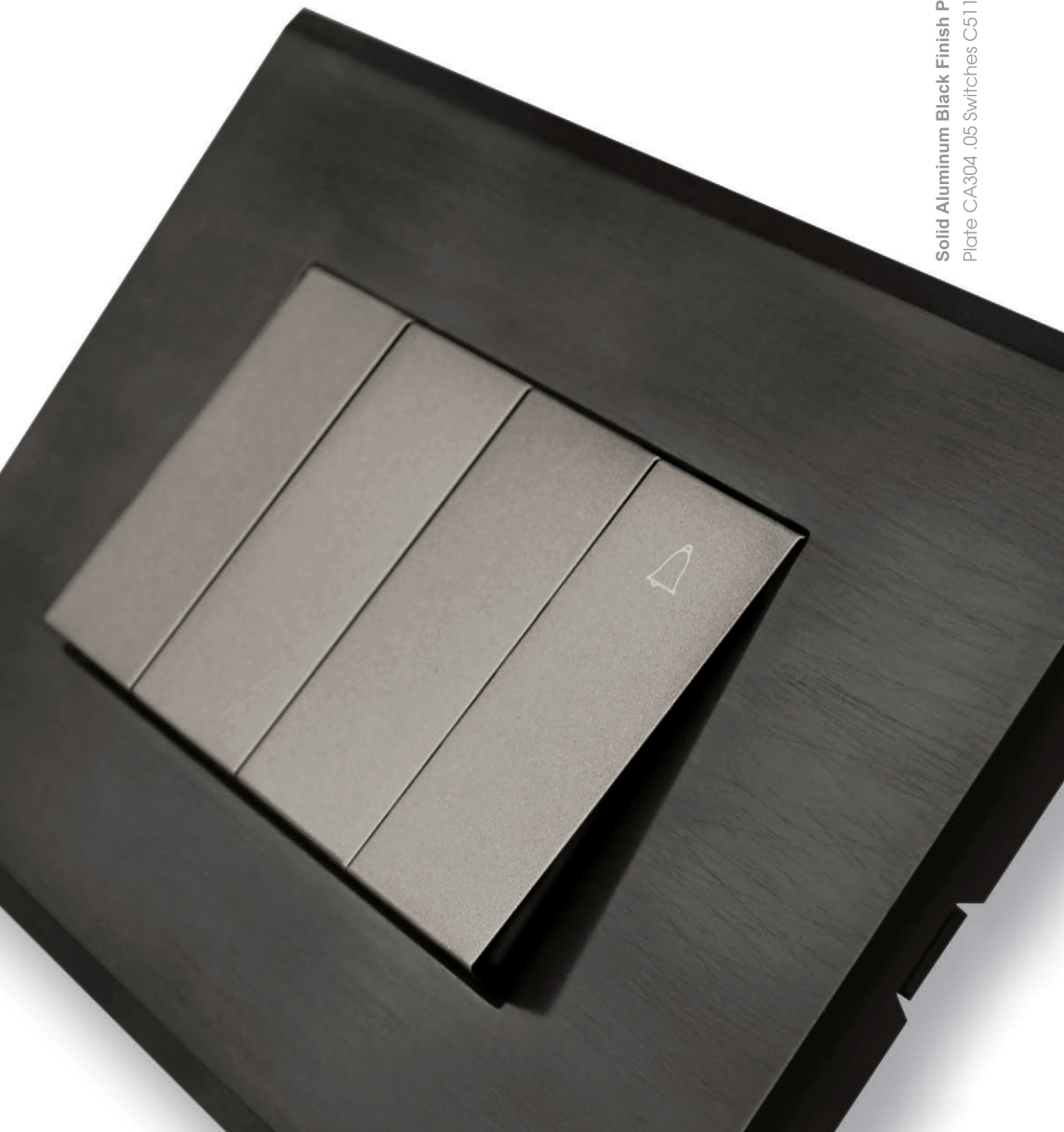

**Solid Aluminum Black Finish Plate with quartz gray switches**  
Plate CA304 .05 Switches C5110 .02 Bell C5310 .02

# CUBE Series

## fan regulators & vector plates

Fan regulator in CUBE Series demonstrates the way engineers at Norisys pay attention to product details. The knob featured in this device solves the common problem of knobs coming off or falling. The dual knob design ensures that the knob cannot be pulled out, thus ensuring that the knobs remain intact even after years of usage.

The unique bar shaped knob is a visual treat and blends with modern interiors, besides being ergonomic. The bar shaped knob is easy to grip and is much more comfortable to operate than regular circular ones.

This fan regulator is a totally dependable device that eliminates failures normally experienced with electronic regulators. It has full rotation operation with no end point, thereby preventing any undue pressure from damaging the regulator. Total hum-free operation, six speeds of operation,

no radio interference and negligible power loss are other benefits of this regulator.

CUBE Series Vector Plates incorporate a redefined design capable of harmoniously blending into different living styles. These plates are available in Frost White, Quartz Grey and Ice Silver colour options. The shape of these plates is urbane and exudes aesthetic elegance. These plates are made from high gloss virgin grade UV stabilized engineering plastics.



**Vector Plate in Ice Silver colour with two switches & fan regulator**  
Plate C5404 .03 Switches C5110 .01 Fan Regulator C5900 .01

Each piece of Solid Aluminum plate is machined out of a solid block of aluminum to give it the sharp and clean look. These plates are available in natural finish and black finish and match very well with Frost White modules and Quartz Gray modules. The complete look is a solid, well engineered smart composition.



# CUBE Series

## special material machined plates

Norisys special material plates set the standards for stylish design combined with top quality materials: Solid Aluminum, Solid Glass, Solid Wood, Solid Marble finish. The classy design creates an exclusive flair owing to the interaction of contrasts between the severity of optical forms and surface finish.

Solid glass plates are made of engineered glass which is tempered and toughened to make it rugged and to impart a nice uniform lustre. Solid glass plates are available in Ice White and Metal Gray colours. Both the options provide a radiance to the interiors.

Solid Wood plates are crafted out of best quality natural wood, which is treated and seasoned to ensure a long life. These plates are offered in Natural Pinewood Polish and Dark Mahogany Polish. Special Protective coatings and surface hardeners make the surface wear

resistant. Wood lends a natural feel to the clean edges of engineering plastics and metals. This natural feel can be an asset for interior designers for making the electrical outlets blend with the furniture.

Solid Marble finish plates are individually machined from solid blocks so that the end product is a crisp clean cut flat plate which looks modern in aesthetics. The Sparkle White option matches very well with white marble whereas the Terra Beige option matches very well with marbles from the Beige and Brown family. Once mounted alongwith the CUBE Series modules, it merges the looks of technical accuracy with natural marble feel.

## CUBE Series

CUBE Series marks the evolution of Norisys' research as it once again focuses on engineering design, especially its environmental qualities, and pivots on the concepts of variability and sustainability, performance and simplicity of use.

16

It is a new way of creating environments, made possible by the types of products that have been developed, namely by using advanced materials and engineering. The result is an installation system that seamlessly blends with the building.

As a professional of electrical switchgear, today Norisys constructs innovative switchgear systems at the highest level and has established itself by sheer experience and high quality workmanship. The two product ranges namely CUBE Series and SQUARE Series, make sure that products are available for highly specific requirements as well.

In CUBE Series switches, the spring geometry of the moving contact of the mechanism has a natural cushioning function, which significantly reduces its electrical recoil as well as wear. An increase in the quantum of silver in the contacts, helps to reconcile the safety of electric switching with smoothness of operation.



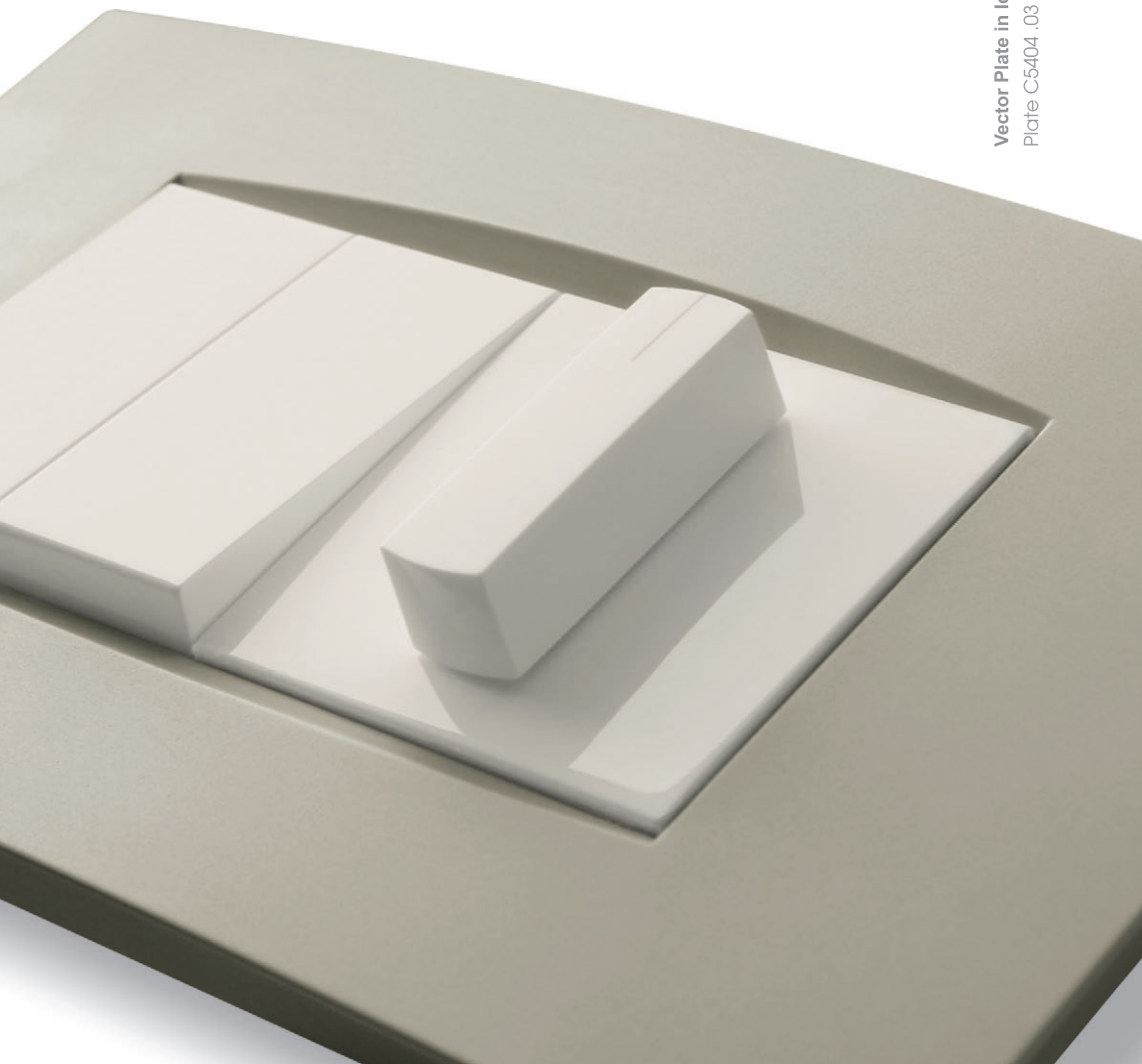

**Vector Plate in Ice Silver colour with two switches & fan regulator**  
Plate C5404 .03 Switches C5110 .01 Fan Regulator C5900 .01

Architecture of modern hotels and hospitals makes the highest demand for design and function of electrical installations. NorisyS offers high-end products suited for the hospitality industry.





## CUBE Series hotel installation systems

CUBE Series installations do not only look good, they are also ideally convenient to operate. Especially for use in hotels and hospitals where one seeks quiet and wellbeing. It is important to have fittings that stand for good feeling.

Products like Shaver Sockets, Key Card Switches, Call bell system with register, Buzzers, Speakers for Music circuits, Step Marker Night Light, Do Not Disturb and Clean My Room dedicated switches, Bell Switch with DND & Clean My Room connections provide the necessary convenience for guests in hotels.

Smart Plates in CUBE Series have a distinct classic design offering comfort to the eye. The plates merge with the interiors very well creating a homogeneous look. Inner bi-material frames give adequate support to the plates keeping all the modules securely in place without yielding to pressure from the wires inside or during insertion / removal of plug tops.

Good quality data sockets are a prerequisite at all workplaces because of increasing speeds in data transmission. Norisys communication sockets are available for all types of telephone and data connections. Shutters for dust protection is provided in all data sockets along with a circuit marking label with a clear cover. The marking can give clear indication on the data line connected to the socket. Communication sockets are available for Cat 5, Cat 6, RJ-11 lines.

# CUBE Series

## single phase motor starters

Single Phase Motor Starters - a safety device designed by Norisys engineers with advanced current handling. It is a device for switching and protection of appliances such as room air-conditioners, refrigerators, washing machines, computers, water coolers, pumps etc. up to 25Amperes. In case of overload, the Single Phase Motor Starter trips, thereby protecting the appliance from burn-out.

These starters are normally mounted with sockets from CUBE Series or SQUARE Series. This combination forms an efficient module for single phase applications. The unit is compact and economical and is operated by the push of buttons located in the front of the Starter.

Installation of Single Phase Motor Starters is very simple as they can be installed simply like a switch. They can also be mounted on Surface Mount Boxes from Norisys for an elegant stylized look.

The unique feature of Single Phase Motor Starters is the facility of current setting. The starter tripping can be precisely set as per the requirement of the individual appliance. This setting can be done simply by the turn of a screw provided on the front panel of the starter. After setting the starter tripping current, the device protects the appliance from overloads with desired precision.

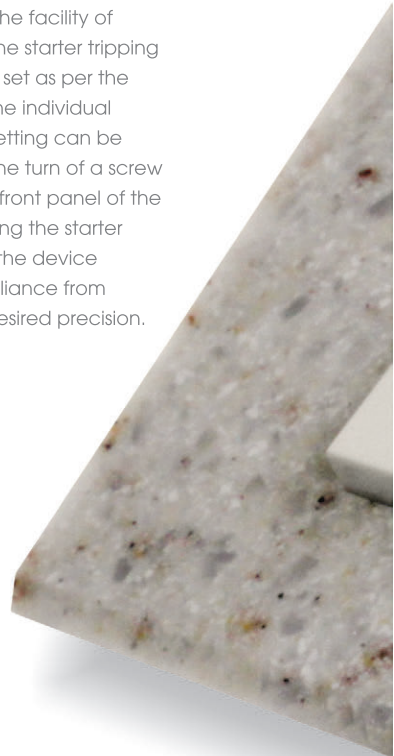



**Solid Marble Finish Plate Terra Beige with switches in Frost White**  
Plate CM304.11 Switches C5110.01 & Fan Regulator C6900.01

# SQUARE Series

SQUARE Series products is a design which has evolved over a period of time. Functional qualities and the mounting system is proven and the technology tested. Classic looks of this range makes it a timeless design.

22

Unique feature of this Series is the mounting system. All modules are mounted on frames using screws. This makes the assembly very sturdy. The modules which are mounted by screws can withstand tremendous amount of pressure. Back housing of sockets rest on the frame and provides a firm support - required in case of excessive push pressure while inserting plugs.

SQUARE Series products retain the special features offered by the company in the past, yet have been redesigned for modernity. Use of thermoset material for the core areas makes the switches and sockets highly durable and capable of handling higher currents.

UV stabilized virgin grade polycarbonate material is used in SQUARE Series to impart a highly polished glossy surface. Locators in the modules and frames facilitate accuracy in mounting ensuring uniform gaps between the modules. Spring loaded tubes in sockets ensure a firm contact with plug pins for smooth operation.



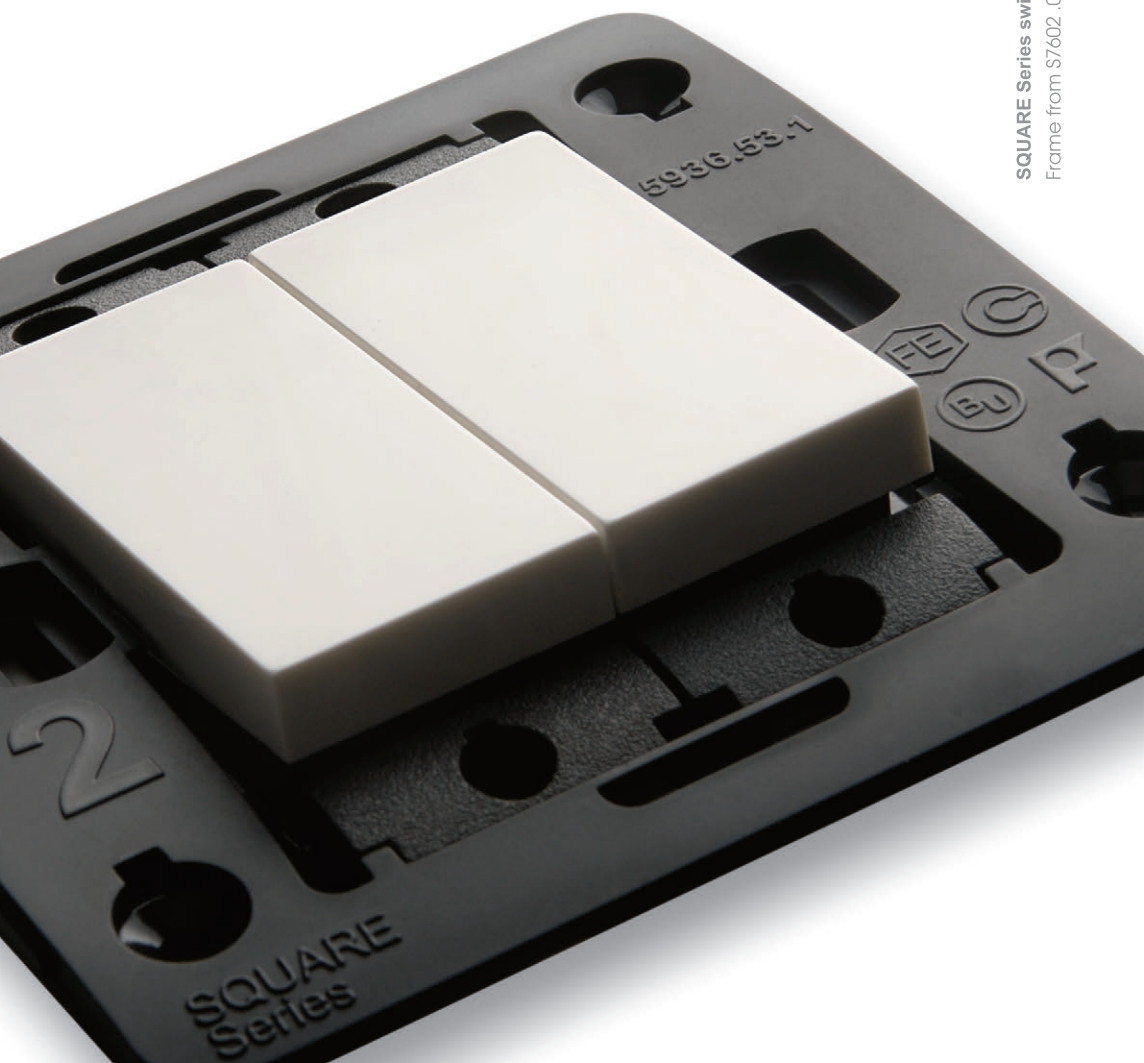

**SQUARE Series switches in frost white with a two module frame**  
Frame from S7602 .01 and switches S7110 .01



C5110 .01  
C5130 .01  
C5730 .01



C5210 .01  
C5230 .01



C5310 .01



C5441 .01

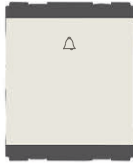

C5340 .01

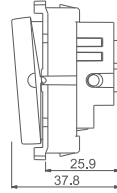

C5111 .01  
C5131 .01  
C5731 .01



C5211 .01  
C5231 .01



C5311 .01



C5431 .01



C5341 .01

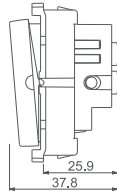

24



C5140 .01  
C5160 .01



C5180 .01



C5240 .01  
C5260 .01



C5280 .01

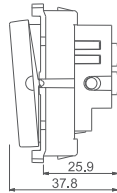

C5141 .01  
C5161 .01



C5191 .01  
C5171 .01



C5241 .01  
C5261 .01



C5281 .01  
C5291 .01

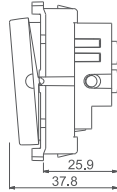

# CUBE Series

## Switches Frost White

Cat no.	Description	Price (Rs.)
<b>C5110 .01</b>	Switch 6A One-way - 1 Module	<b>155.00</b>
<b>C5111 .01</b>	Switch 6A One-way with indicator - 1 Module	<b>232.00</b>
<b>C5210 .01</b>	Switch 6A Two-way - 1 Module	<b>211.00</b>
<b>C5211 .01</b>	Switch 6A Two-way with indicator - 1 Module	<b>310.00</b>
<b>C5130 .01</b>	Switch 16A One-way - 1 Module	<b>251.00</b>
<b>C5131 .01</b>	Switch 16A One-way with indicator - 1 Module	<b>317.00</b>
<b>C5230 .01</b>	Switch 16A Two-way - 1 Module	<b>268.00</b>
<b>C5231 .01</b>	Switch 16A Two-way with indicator - 1 Module	<b>347.00</b>
<b>C5730 .01</b>	Switch 25A One-way - 1 Module	<b>354.00</b>
<b>C5731 .01</b>	Switch 25A One-way with indicator - 1 Module	<b>417.00</b>
<b>C5310 .01</b>	Switch 6A - Bell - 1 Module	<b>224.00</b>
<b>C5311 .01</b>	Switch 6A - Bell with indicator - 1 Module	<b>309.00</b>
<b>C5140 .01</b>	Palm Switch 6A One-way Single Pole - 2 Module	<b>201.00</b>
<b>C5141 .01</b>	Palm Switch 6A One-way Single Pole with indicator - 2 Module	<b>260.00</b>
<b>C5240 .01</b>	Palm Switch 6A Two-way Single Pole - 2 Module	<b>233.00</b>
<b>C5241 .01</b>	Palm Switch 6A Two-way Single Pole with indicator - 2 Module	<b>330.00</b>
<b>C5160 .01</b>	Palm Switch 16A One-way Single Pole - 2 Module	<b>271.00</b>
<b>C5161 .01</b>	Palm Switch 16A One-way Single Pole with indicator - 2 Module	<b>330.00</b>
<b>C5260 .01</b>	Palm Switch 16A Two-way Single Pole - 2 Module	<b>296.00</b>
<b>C5261 .01</b>	Palm Switch 16A Two-way Single Pole with indicator - 2 Module	<b>385.00</b>
<b>C5180 .01</b>	Palm Switch 6A One-way Double Pole - 2 Module	<b>378.00</b>
<b>C5280 .01</b>	Palm Switch 6A Two-way Double Pole - 2 Module	<b>402.00</b>
<b>C5281 .01</b>	Palm Switch 6A Two-way Double Pole with indicator - 2 Module	<b>447.00</b>
<b>C5191 .01</b>	Palm Switch 16A One-way Double Pole with indicator - 2 Module	<b>526.00</b>
<b>C5291 .01</b>	Palm Switch 16A Two-way Double Pole with indicator - 2 Module	<b>626.00</b>
<b>C5171 .01</b>	Palm Switch 25A One-way Double Pole with indicator - 2 Module	<b>629.00</b>
<b>C5340 .01</b>	Palm Bell Switch Single Pole - 2 Module	<b>278.00</b>
<b>C5341 .01</b>	Palm Bell Switch Single Pole with indicator - 2 Module	<b>359.00</b>
<b>C5441 .01</b>	Switch 16A One-way with 'Geyser' Symbol with indicator - 1 Module	<b>344.00</b>
<b>C5431 .01</b>	Switch 6A One-way with 'Fan' or 'Light' or 'Exhaust' symbol - 1 Module	<b>260.00</b>



C2110.01



C2111.01



C2010.01



C2011.01



C2130.01

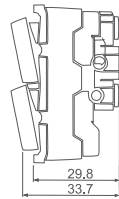

C2131.01



C2030.01



C2031.01



C2140.01



C2141.01

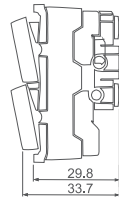

C2040.01



C2041.01

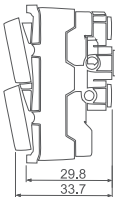



## CUBE Series

### Twin Switches Frost White

Cat no.	Description	Price (Rs.)
<b>C2110 .01</b>	Twin Switch 6A - 2 Gang - Both switches 1 way - 1 Module	<b>488.00</b>
<b>C2111 .01</b>	Twin Switch 6A - 2 Gang - 1 way + 1 way with indicator - 1 Module	<b>695.00</b>
<b>C2010 .01</b>	Twin Switch 6A - 1 Gang - 2 way + Dummy - 1 Module	<b>543.00</b>
<b>C2011 .01</b>	Twin Switch 6A - 1 Gang - 2 way with indicator + Dummy - 1 Module	<b>761.00</b>
<b>C2130 .01</b>	Twin Switch 16A - 2 Gang - Both switches 1 way - 1 Module	<b>759.00</b>
<b>C2131 .01</b>	Twin Switch 16A - 2 Gang - 1 way + 1 way with indicator - 1 Module	<b>954.00</b>
<b>C2030 .01</b>	Twin Switch 16A - 1 Gang - 2 way + Dummy - 1 Module	<b>719.00</b>
<b>C2031 .01</b>	Twin Switch 16A - 1 Gang - 2 way with indicator + Dummy - 1 Module	<b>922.00</b>
<b>C2140 .01</b>	Twin Switch 6A - 2 Gang - Both Switches Bell - 1 Module	<b>720.00</b>
<b>C2141 .01</b>	Twin Switch 6A - 2 Gang - 1 Bell + 1 Bell with Indicator - 1 Module	<b>951.00</b>
<b>C2040 .01</b>	Twin Switch 6A - 1 Gang - 1 Bell + 1 Dummy - 1 Module	<b>580.00</b>
<b>C2041 .01</b>	Twin Switch 6A - 1 Gang - 1 Bell with Indicator + 1 Dummy - 1 Module	<b>759.00</b>



C5213 .01



C5331 .01



C5332 .01

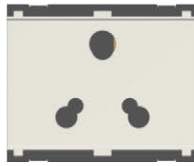

C5552 .01

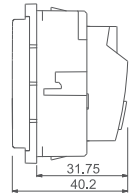

C5212 .01



C5532 .01

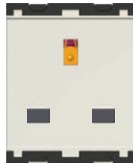

C5531 .01

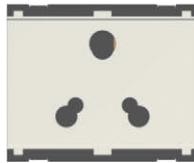

C5752 .01

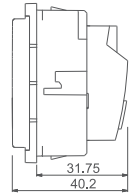

C5010 .01

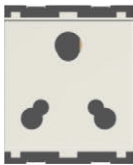

C5732 .01

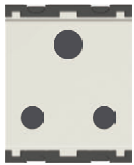

C5733 .01



C5902 .01  
C5903 .01  
C5909 .01

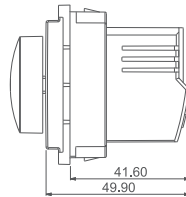

C5904 .01



C5905 .01  
C5908 .01



C5900 .01  
C5910 .01  
C5912 .01



C5901 .01  
C5911 .01



C5913 .01

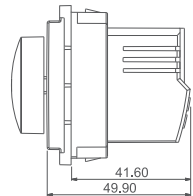

# CUBE Series

## Sockets Frost White

Cat no.	Description	Price (Rs.)
<b>C5213 .01</b>	Socket 6A 3-Pin-only Shuttered - 2 Module (As per Indian Standard)	<b>303.00</b>
<b>C5332 .01</b>	Socket 16A and 6A 3-Pin Shuttered - 2 Module (As per Indian Standard)	<b>395.00</b>
<b>C5552 .01</b>	Socket 16A and 6A 3-Pin Shuttered - 3 Module (As per Indian Standard)	<b>453.00</b>
<b>C5331 .01</b>	Socket 16A 3-Pin-only Shuttered - 2 Module (As per Indian Standard)	<b>383.00</b>
<b>C5212 .01</b>	Socket 6A 3+2 Pin [Round & Flat] Shuttered - 2 Module *	<b>324.00</b>
<b>C5010 .01</b>	Socket 6A 2 Pin [Round & Flat] - 1 Module *	<b>219.00</b>
<b>C5532 .01</b>	Socket 13A International Multi socket Shuttered - 2 Module *	<b>395.00</b>
<b>C5531 .01</b>	Socket 13A 3-Pin Flat-only Socket Shuttered - 2 Module *	<b>373.00</b>
<b>C5732 .01</b>	Socket 25A and 6A 3-Pin Shuttered - 2 Module *	<b>458.00</b>
<b>C5752 .01</b>	Socket 25A and 6A 3-Pin Shuttered - 3 Module *	<b>540.00</b>
<b>C5733 .01</b>	Socket 25A 3-Pin-only Shuttered - 2 Module *	<b>440.00</b>

29

## Fan Regulators & Dimmers Frost White

<b>C5900 .01</b>	Fan Regulator for 80W fan - Step Type with Bar Knob - 2 Module	<b>1025.00</b>
<b>C5901 .01</b>	Fan Regulator for 80W fan - Step Type with Round Knob - 2 Module	<b>983.00</b>
<b>C5910 .01</b>	Fan Regulator for 120W fan - Step Type with Bar Knob - 2 Module	<b>1127.00</b>
<b>C5911 .01</b>	Fan Regulator for 120W fan - Step Type with Round Knob - 2 Module	<b>1087.00</b>
<b>C5912 .01</b>	Fan Regulator for 120W fan - 8-Step Type with Bar Knob - 2 Module	<b>1173.00</b>
<b>C5913 .01</b>	Fan Regulator for 120W fan - 8-Step Type with Round Knob - 2 Module	<b>1130.00</b>
<b>C5902 .01</b>	Dimmer 500 Watts - 2 Module	<b>824.00</b>
<b>C5903 .01</b>	Dimmer 1000 Watts - 2 Module	<b>1153.00</b>
<b>C5904 .01</b>	Fan Regulator Single Module for 80W Fan - Step Type - 1 Module	<b>674.00</b>
<b>C5905 .01</b>	Dimmer 500 Watts - 1 Module	<b>635.00</b>
<b>C5908 .01</b>	Dimmer for LED Lights 100W (3 wire system) - 1 Module	<b>631.00</b>
<b>C5909 .01</b>	Dimmer for LED Lights Digital Choke 100W (4 wire system) - 2 Module	<b>824.00</b>

\* Only for export outside India



C5707 .01  
C5708 .01



C5703 .01  
C5704 .01  
C5705 .01  
C5505 .01



C5715 .01  
C5716 .01



C5727 .01



C5706 .01  
C5709 .01



C5721 .01



C5710 .01

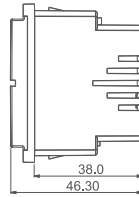

# CUBE Series

## Acoustic & Optical Signaling Frost White

Cat no.	Description	Price (Rs.)
<b>C5707 .01</b>	Electronic Bell - 2 Module	<b>637.00</b>
<b>C5727 .01</b>	Indicator Light - 1 Module	<b>289.00</b>
<b>C5703 .01</b>	Prismatic Overdoor Bulkhead Indicator - White - 2 Module	<b>580.00</b>
<b>C5704 .01</b>	Prismatic Overdoor Bulkhead Indicator - Green - 2 Module	<b>599.00</b>
<b>C5705 .01</b>	Prismatic Overdoor Bulkhead Indicator - Red - 2 Module	<b>599.00</b>
<b>C5505 .01</b>	Prismatic Overdoor Bulkhead Indicator - Resettable - 2 Module	<b>905.00</b>
<b>C5715 .01</b>	Emergency Light - 2 Module	<b>1549.00</b>
<b>C5706 .01</b>	Speaker for audio music circuit - 2 Module	<b>1127.00</b>
<b>C5716 .01</b>	Night Light with switch and dimming option - 2 Module	<b>983.00</b>
<b>C5721 .01</b>	Step Marker Lamp/ Night Lamp - 2 Module	<b>649.00</b>
<b>C5709 .01</b>	Electronic Buzzer - 2 Module	<b>577.00</b>
<b>C5710 .01</b>	Electronic Buzzer - 1 Module	<b>511.00</b>
<b>C5708 .01</b>	Ultrasonic Mosquito Repellent - 2 Module	<b>912.00</b>



C5712 .01



C5460 .01

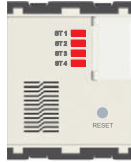

C5711 .01



C5262 .01  
C5263 .01

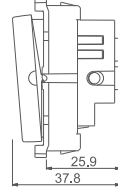

C5450 .01

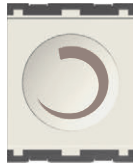

C5906 .01



C5233 .01



C5232 .01

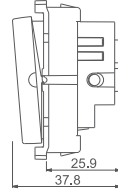

C5718 .01

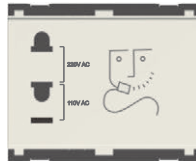

C5723 .01



C5719 .01

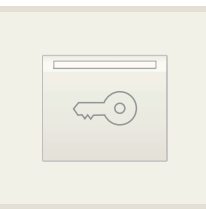
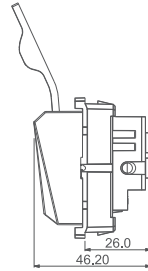

C5717 .01

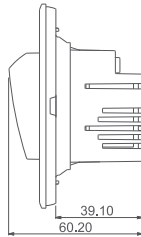

# CUBE Series

## Hospitality Modules Frost White

Cat no.	Description	Price (Rs.)
<b>C5717 .01</b>	25A Smart Card operated Electronic switch in 2 Module with indicator & exit time delay feature including Smart Card - 2 Module	<b>3010.00</b>
<b>C5718 .01</b>	25A Smart Card operated Electronic switch in 3 Module with indicator & exit time delay feature including Smart Card - 3 Module	<b>2781.00</b>
<b>C5724 .01</b>	Smart Card - Customized	<b>210.00</b>
<b>C5719 .01</b>	25A Key Fob Switch Double Pole with indicator - 2 Module	<b>1355.00</b>
<b>C5720 .01</b>	Key Fob - Customized	<b>214.00</b>
<b>C5723 .01</b>	Shaver Socket 220V/110V - 3 Module	<b>2640.00</b>
<b>C5711 .01</b>	Call Bell Station with Register and provision for External Buzzer - 2M	<b>1497.00</b>
<b>C5712 .01</b>	External Buzzer for Call Bell Station - 2 Module	<b>534.00</b>
<b>C5232 .01</b>	"Do Not Disturb" Switch with indicator - 1 Module	<b>430.00</b>
<b>C5233 .01</b>	"Clean My Room" Switch with indicator - 1 Module	<b>430.00</b>
<b>C5906 .01</b>	Volume Control 100 Ohms 1 Watt - 2 Module	<b>716.00</b>
<b>C5262 .01</b>	Bell Switch with "Do Not Disturb" & "Clean My Room" Indicator - 2M	<b>696.00</b>
<b>C5263 .01</b>	Bell Switch with "DND", "CMR" & Guest is in Indicator - 2M	<b>771.00</b>
<b>C5450 .01</b>	Push Button station (Start - Stop) - 2 Module	<b>600.00</b>
<b>C5460 .01</b>	Curtain Control Switch 6A - 2 Module	<b>665.00</b>



C5729 .01



C5739 .01



C5800 .01  
C5809 .01



C5701 .01



C5700 .01



C5802 .01  
C5803 .01

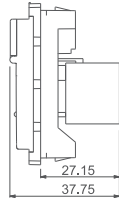

C5725 .01  
C5736 .01



C5836 .01



C5797 .01



C5500 .01



C5798 .01



C5820 .01

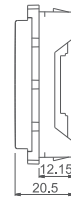

34



C5936 .01



C5937 .01

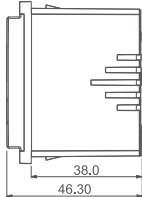

P5131 .01



P5151 .01



P5111 .01



# CUBE Series

## Communiqué & Support Modules Frost White

Cat no.	Description	Price (Rs.)
<b>C5797 .01</b>	Coaxial T.V Socket - 1 Module	<b>230.00</b>
<b>C5725 .01</b>	USB Extension Socket - 1 Module	<b>547.00</b>
<b>C5736 .01</b>	USB Charger Socket Outlet A Type - 2.1 Amps - 1 Module	<b>2499.00</b>
<b>C5836 .01</b>	USB Charger Socket Outlet C Type - 2.1 Amps - 1 Module	<b>2764.00</b>
<b>C5936 .01</b>	USB Charger Socket Outlet A+C Type - 2.1 Amps - 1 Module	<b>2987.00</b>
<b>C5937 .01</b>	USB Charger Socket Outlet C+C Type - 3.1 Amps - 1 Module	<b>3448.00</b>
<b>C5729 .01</b>	Computer Monitor Output Socket - 1 Module	<b>381.00</b>
<b>C5739 .01</b>	HDMI Socket - 1 Module	<b>1489.00</b>
<b>C5800 .01</b>	Telephone Socket RJ-11 Double Line Shuttered - 1 Module	<b>220.00</b>
<b>C5820 .01</b>	Twin Telephone Socket RJ-11 - 1 Module	<b>356.00</b>
<b>C5802 .01</b>	Information Socket 6e - UTP Shuttered - 1 Module	<b>814.00</b>
<b>C5803 .01</b>	Information Socket 6a - UTP Shuttered - 1 Module	<b>1374.00</b>
<b>C5701 .01</b>	Triple RCA Audio Visual Socket - 1 Module	<b>754.00</b>
<b>C5500 .01</b>	Cord Outlet - 1 Module	<b>167.00</b>
<b>C5700 .01</b>	Blanking Plate - 1 Module	<b>57.00</b>
<b>C5798 .01</b>	Audio Port / Jack 3.5mm - 1 Module	<b>437.00</b>
<b>C5809 .01</b>	Fitment for RJ-45 Computer Socket Shuttered - 1 Module	<b>246.00</b>

35

## Plugs Transparent with Dark Gray

<b>P5111 .01</b>	Plug Top 6A with LED indicator	<b>155.00</b>
<b>P5131 .01</b>	Plug Top 16A with LED indicator	<b>226.00</b>
<b>P5151 .01</b>	Plug Top 25A with LED indicator	<b>281.00</b>



V5110 .01  
V5210 .01  
V5130 .01  
V5230 .01



V5111 .01  
V5211 .01  
V5131 .01  
V5231 .01



V5140 .01  
V5240 .01  
V5160 .01  
V5180 .01

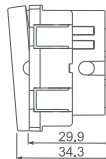

V5141 .01  
V5241 .01  
V5161 .01  
V5261 .01



V5281 .01  
V5191 .01  
V5291 .01  
V5171 .01



V5340 .01  
V5341 .01

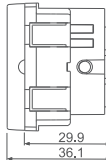

V5901 .01  
V5911 .01



V5913 .01



V5900 .01  
V5910 .01  
V5912 .01

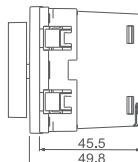

Vertical Switches and Vertical Fan Regulators can be mounted on all types of standard Cube Series Plates. Metal Boxes, Frames and Plates need to be fixed in the vertical position as shown here.

## CUBE Series

### Vertical Switches Frost White

Cat no.	Description	Price (Rs.)
<b>V5110 .01</b>	Vertical Switches - 2 Gang - Both switches 6A 1 way - 2 Module	<b>372.00</b>
<b>V5111 .01</b>	Vertical Switches - 2 Gang - Both switches 6A 1 way with indicator - 2M	<b>486.00</b>
<b>V5210 .01</b>	Vertical Switches - 2 Gang - Both switches 6A 2 way - 2 Module	<b>449.00</b>
<b>V5211 .01</b>	Vertical Switches - 2 Gang - Both switches 6A 2 way with indicator - 2M	<b>646.00</b>
<b>V5130 .01</b>	Vertical Switches - 2 Gang - Both switches 16A 1 way - 2 Module	<b>531.00</b>
<b>V5131 .01</b>	Vertical Switches - 2 Gang - Both switches 16A 1 way with indicator - 2M	<b>665.00</b>
<b>V5230 .01</b>	Vertical Switches - 2 Gang - Both switches 16A 2 way - 2 Module	<b>562.00</b>
<b>V5231 .01</b>	Vertical Switches - 2 Gang - Both switches 16A 2 way with indicator - 2M	<b>726.00</b>
<b>V5140 .01</b>	Vertical Palm Switch 6A 1 way Single Pole - 2 Module	<b>206.00</b>
<b>V5141 .01</b>	Vertical Palm Switch 6A 1 way Single Pole with indicator - 2 Module	<b>260.00</b>
<b>V5240 .01</b>	Vertical Palm Switch 6A 2 way Single Pole - 2 Module	<b>233.00</b>
<b>V5241 .01</b>	Vertical Palm Switch 6A 2 way Single Pole with indicator - 2 Module	<b>330.00</b>
<b>V5160 .01</b>	Vertical Palm Switch 16A 1 way Single Pole - 2 Module	<b>272.00</b>
<b>V5161 .01</b>	Vertical Palm Switch 16A 1 way Single Pole with indicator - 2 Module	<b>330.00</b>
<b>V5261 .01</b>	Vertical Palm Switch 16A 2 way Single Pole with indicator - 2 Module	<b>384.00</b>
<b>V5180 .01</b>	Vertical Palm Switch 6A 1 way Double Pole - 2 Module	<b>378.00</b>
<b>V5281 .01</b>	Vertical Palm Switch 6A 2 way Double Pole with indicator - 2 Module	<b>447.00</b>
<b>V5191 .01</b>	Vertical Palm Switch 16A 1 way Double Pole with indicator - 2 Module	<b>526.00</b>
<b>V5291 .01</b>	Vertical Palm Switch 16A 2 way Double Pole with indicator - 2 Module	<b>627.00</b>
<b>V5171 .01</b>	Vertical Palm Switch 25A 1 way Double Pole with indicator - 2 Module	<b>629.00</b>
<b>V5340 .01</b>	Vertical Palm Bell Switch Single Pole - 2 Module	<b>278.00</b>
<b>V5341 .01</b>	Vertical Palm Bell Switch Single Pole with indicator - 2 Module	<b>360.00</b>

37

### Vertical Fan Regulators & Dimmers Frost White

<b>V5900 .01</b>	Vertical Fan Regulator for 80W fan - Step Type with Bar Knob - 2M	<b>1025.00</b>
<b>V5901 .01</b>	Vertical Fan Regulator for 80W fan - Step Type with Round Knob - 2M	<b>982.00</b>
<b>V5910 .01</b>	Vertical Fan Regulator for 120W fan - Step Type with Bar Knob - 2M	<b>1127.00</b>
<b>V5911 .01</b>	Vertical Fan Regulator for 120W fan - Step Type with Round Knob - 2M	<b>1086.00</b>
<b>V5912 .01</b>	Vertical Fan Regulator for 120W fan - 8-Step Type with Bar Knob - 2M	<b>1173.00</b>
<b>V5913 .01</b>	Vertical Fan Regulator for 120W fan - 8-Step Type with Round Knob-2M	<b>1130.00</b>
<b>V5902 .01</b>	Vertical Dimmer 500 Watts - 2 Module	<b>823.00</b>



C5110 .02  
C5130 .02  
C5730 .02



C5210 .02  
C5230 .02



C5310 .02



C5441 .02

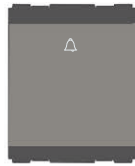

C5340 .02

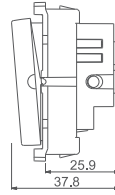

C5111 .02  
C5131 .02  
C5731 .02



C5211 .02  
C5231 .02



C5311 .02



C5431 .02



C5341 .02

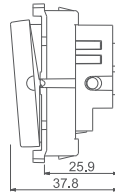

C5140 .02  
C5160 .02



C5180 .02

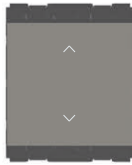

C5240 .02  
C5260 .02



C5280 .02

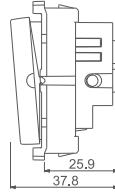

C5141 .02  
C5161 .02



C5191 .02  
C5171 .02



C5241 .02  
C5261 .02



C5281 .02  
C5291 .02

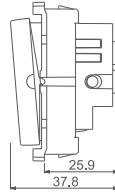

# CUBE Series

## Switches Quartz Gray

Cat no.	Description	Price (Rs.)
<b>C5110 .02</b>	Switch 6A One-way - 1 Module	<b>191.00</b>
<b>C5111 .02</b>	Switch 6A One-way with indicator - 1 Module	<b>296.00</b>
<b>C5210 .02</b>	Switch 6A Two-way - 1 Module	<b>268.00</b>
<b>C5211 .02</b>	Switch 6A Two-way with indicator - 1 Module	<b>384.00</b>
<b>C5130 .02</b>	Switch 16A One-way - 1 Module	<b>317.00</b>
<b>C5131 .02</b>	Switch 16A One-way with indicator - 1 Module	<b>403.00</b>
<b>C5230 .02</b>	Switch 16A Two-way - 1 Module	<b>339.00</b>
<b>C5231 .02</b>	Switch 16A Two-way with indicator - 1 Module	<b>440.00</b>
<b>C5730 .02</b>	Switch 25A One-way - 1 Module	<b>449.00</b>
<b>C5731 .02</b>	Switch 25A One-way with indicator - 1 Module	<b>520.00</b>
<b>C5310 .02</b>	Switch 6A - Bell - 1 Module	<b>279.00</b>
<b>C5311 .02</b>	Switch 6A - Bell with indicator - 1 Module	<b>392.00</b>
<b>C5140 .02</b>	Palm Switch 6A One-way Single Pole - 2 Module	<b>249.00</b>
<b>C5141 .02</b>	Palm Switch 6A One-way Single Pole with indicator - 2 Module	<b>324.00</b>
<b>C5240 .02</b>	Palm Switch 6A Two-way Single Pole - 2 Module	<b>289.00</b>
<b>C5241 .02</b>	Palm Switch 6A Two-way Single Pole with indicator - 2 Module	<b>410.00</b>
<b>C5160 .02</b>	Palm Switch 16A One-way Single Pole - 2 Module	<b>337.00</b>
<b>C5161 .02</b>	Palm Switch 16A One-way Single Pole with indicator - 2 Module	<b>410.00</b>
<b>C5260 .02</b>	Palm Switch 16A Two-way Single Pole - 2 Module	<b>368.00</b>
<b>C5261 .02</b>	Palm Switch 16A Two-way Single Pole with indicator - 2 Module	<b>480.00</b>
<b>C5180 .02</b>	Palm Switch 6A One-way Double Pole - 2 Module	<b>469.00</b>
<b>C5280 .02</b>	Palm Switch 6A Two-way Double Pole - 2 Module	<b>500.00</b>
<b>C5281 .02</b>	Palm Switch 6A Two-way Double Pole with indicator - 2 Module	<b>555.00</b>
<b>C5191 .02</b>	Palm Switch 16A One-way Double Pole with indicator - 2 Module	<b>654.00</b>
<b>C5291 .02</b>	Palm Switch 16A Two-way Double Pole with indicator - 2 Module	<b>779.00</b>
<b>C5171 .02</b>	Palm Switch 25A One-way Double Pole with indicator - 2 Module	<b>782.00</b>
<b>C5340 .02</b>	Palm Bell Switch Single Pole - 2 Module	<b>347.00</b>
<b>C5341 .02</b>	Palm Bell Switch Single Pole with indicator - 2 Module	<b>445.00</b>
<b>C5441 .02</b>	Switch 16A One-way with 'Geyser' Symbol with indicator - 1 Module	<b>427.00</b>
<b>C5431 .02</b>	Switch 6A One-way with 'Fan' or 'Light' or 'Exhaust' symbol - 1 Module	<b>324.00</b>



C2110.02



C2111.02



C2010.02



C2011.02



C2130.02

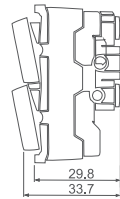

C2131.02



C2030.02



C2031.02



C2140.02



C2141.02

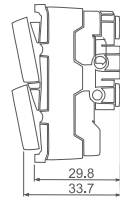

C2040.02



C2041.02

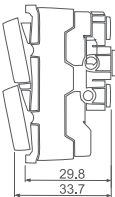

## CUBE Series

### Twin Switches Quartz Gray

Cat no.	Description	Price (Rs.)
<b>C2110 .02</b>	Twin Switch 6A - 2 Gang - Both switches 1 way - 1 Module	<b>601.00</b>
<b>C2111 .02</b>	Twin Switch 6A - 2 Gang - 1 way + 1 way with indicator - 1 Module	<b>908.00</b>
<b>C2010 .02</b>	Twin Switch 6A - 1 Gang - 2 way + Dummy - 1 Module	<b>698.00</b>
<b>C2011 .02</b>	Twin Switch 6A - 1 Gang - 2 way with indicator + Dummy - 1 Module	<b>979.00</b>
<b>C2130 .02</b>	Twin Switch 16A - 2 Gang - Both switches 1 way - 1 Module	<b>980.00</b>
<b>C2131 .02</b>	Twin Switch 16A - 2 Gang - 1 way + 1 way with indicator - 1 Module	<b>1223.00</b>
<b>C2030 .02</b>	Twin Switch 16A - 1 Gang - 2 way + Dummy - 1 Module	<b>926.00</b>
<b>C2031 .02</b>	Twin Switch 16A - 1 Gang - 2 way with indicator + Dummy - 1 Module	<b>1189.00</b>
<b>C2140 .02</b>	Twin Switch 6A - 2 Gang - Both Switches Bell - 1 Module	<b>921.00</b>
<b>C2141 .02</b>	Twin Switch 6A - 2 Gang - 1 Bell + 1 Bell with Indicator - 1 Module	<b>1217.00</b>
<b>C2040 .02</b>	Twin Switch 6A - 1 Gang - 1 Bell + 1 Dummy - 1 Module	<b>742.00</b>
<b>C2041 .02</b>	Twin Switch 6A - 1 Gang - 1 Bell with Indicator + 1 Dummy - 1 Module	<b>971.00</b>



C5213 .02



C5331 .02



C5332 .02

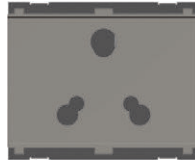

C5552 .02

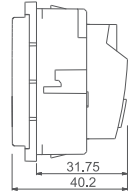

C5212 .02



C5532 .02



C5531 .02

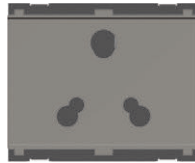

C5752 .02

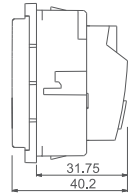

C5010 .02



C5732 .02



C5733 .02



C5902 .02  
C5903 .02  
C5909 .02

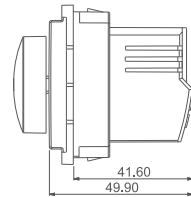

C5904 .02



C5905 .02  
C5908 .02



C5900 .02  
C5910 .02  
C5912 .02



C5901 .02  
C5911 .02



C5913 .02

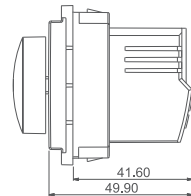



# CUBE Series

## Sockets Quartz Gray

Cat no.	Description	Price (Rs.)
<b>C5213 .02</b>	Socket 6A 3-Pin-only Shuttered - 2 Module (As per Indian Standard)	<b>374.00</b>
<b>C5332 .02</b>	Socket 16A and 6A 3-Pin Shuttered - 2 Module (As per Indian Standard)	<b>481.00</b>
<b>C5552 .02</b>	Socket 16A and 6A 3-Pin Shuttered - 3 Module (As per Indian Standard)	<b>552.00</b>
<b>C5331 .02</b>	Socket 16A 3-Pin-only Shuttered - 2 Module (As per Indian Standard)	<b>467.00</b>
<b>C5212 .02</b>	Socket 6A 3+2 Pin [Round & Flat] Shuttered - 2 Module *	<b>399.00</b>
<b>C5010 .02</b>	Socket 6A 2 Pin [Round & Flat] - 1 Module *	<b>268.00</b>
<b>C5532 .02</b>	Socket 13A International Multi socket Shuttered - 2 Module *	<b>481.00</b>
<b>C5531 .02</b>	Socket 13A 3-Pin Flat-only Socket Shuttered - 2 Module *	<b>457.00</b>
<b>C5732 .02</b>	Socket 25A and 6A 3-Pin Shuttered - 2 Module *	<b>559.00</b>
<b>C5752 .02</b>	Socket 25A and 6A 3-Pin Shuttered - 3 Module *	<b>659.00</b>
<b>C5733 .02</b>	Socket 25A 3-Pin-only Shuttered - 2 Module *	<b>539.00</b>

## Fan Regulators & Dimmers Quartz Gray

43

<b>C5900 .02</b>	Fan Regulator for 80W fan - Step Type with Bar Knob - 2 Module	<b>1264.00</b>
<b>C5901 .02</b>	Fan Regulator for 80W fan - Step Type with Round Knob - 2 Module	<b>1208.00</b>
<b>C5910 .02</b>	Fan Regulator for 120W fan - Step Type with Bar Knob - 2 Module	<b>1389.00</b>
<b>C5911 .02</b>	Fan Regulator for 120W fan - Step Type with Round Knob - 2 Module	<b>1339.00</b>
<b>C5912 .02</b>	Fan Regulator for 120W fan - 8-Step Type with Bar Knob - 2 Module	<b>1445.00</b>
<b>C5913 .02</b>	Fan Regulator for 120W fan - 8-Step Type with Round Knob - 2 Module	<b>1393.00</b>
<b>C5902 .02</b>	Dimmer 500 Watts - 2 Module	<b>1016.00</b>
<b>C5903 .02</b>	Dimmer 1000 Watts - 2 Module	<b>1424.00</b>
<b>C5904 .02</b>	Fan Regulator Single Module for 80W Fan - Step Type - 1 Module	<b>828.00</b>
<b>C5905 .02</b>	Dimmer 500 Watts - 1 Module	<b>783.00</b>
<b>C5908 .02</b>	Dimmer for LED Lights 100W (3 wire system) - 1 Module	<b>778.00</b>
<b>C5909 .02</b>	Dimmer for LED Lights with Digital Choke 100W (4 wire system) - 2M	<b>1016.00</b>

\* Only for export outside India



C5707 .02  
C5708 .02



C5703 .01  
C5704 .01  
C5705 .01  
C5505 .01



C5715 .02  
C5716 .02



C5727 .02

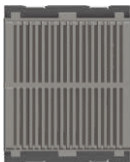

C5706 .02  
C5709 .02



C5721 .02



C5710 .02

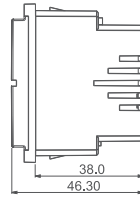

# CUBE Series

## Acoustic & Optical Signaling Quartz Gray

Cat no.	Description	Price (Rs.)
<b>C5707 .02</b>	Electronic Bell - 2 Module	<b>794.00</b>
<b>C5727 .02</b>	Indicator Light - 1 Module	<b>359.00</b>
<b>C5703 .01</b>	Prismatic Overdoor Bulkhead Indicator - White - 2 Module	<b>580.00</b>
<b>C5704 .01</b>	Prismatic Overdoor Bulkhead Indicator - Green - 2 Module	<b>599.00</b>
<b>C5705 .01</b>	Prismatic Overdoor Bulkhead Indicator - Red - 2 Module	<b>599.00</b>
<b>C5505 .01</b>	Prismatic Overdoor Bulkhead Indicator - Resettable - 2 Module	<b>905.00</b>
<b>C5715 .02</b>	Emergency Light - 2 Module	<b>1926.00</b>
<b>C5706 .02</b>	Speaker for audio music circuit - 2 Module	<b>1399.00</b>
<b>C5716 .02</b>	Night Light with switch and dimming option - 2 Module	<b>1222.00</b>
<b>C5721 .02</b>	Step Marker Lamp/ Night Lamp - 2 Module	<b>806.00</b>
<b>C5709 .02</b>	Electronic Buzzer - 2 Module	<b>718.00</b>
<b>C5710 .02</b>	Electronic Buzzer - 1 Module	<b>634.00</b>
<b>C5708 .02</b>	Ultrasonic Mosquito Repellent - 2 Module	<b>1135.00</b>



C5712 .02



C5460 .02



C5711 .02



C5262 .02  
C5263 .02

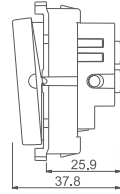

C5450 .02



C5906 .02



C5233 .02



C5232 .02

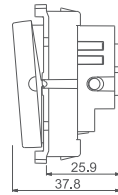

C5718 .02



C5723 .02



C5719 .02

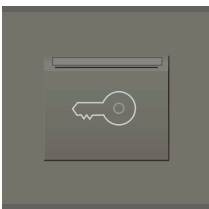
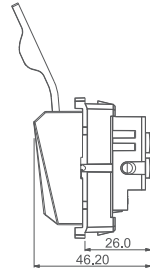

C5717 .02

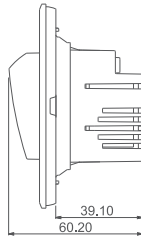

# CUBE Series

## Hospitality Modules Quartz Gray

Cat no.	Description	Price (Rs.)
<b>C5717 .02</b>	25A Smart Card operated Electronic switch in 2 Module with indicator & exit time delay feature including Smart Card - 2 Module	<b>3270.00</b>
<b>C5718 .02</b>	25A Smart Card operated Electronic switch in 3 Module with indicator & exit time delay feature including Smart Card - 3 Module	<b>3036.00</b>
<b>C5724 .02</b>	Smart Card - Customized	<b>210.00</b>
<b>C5719 .02</b>	25A Key Fob Switch Double Pole with indicator - 2 Module	<b>1624.00</b>
<b>C5720 .02</b>	Key Fob - Customized	<b>241.00</b>
<b>C5723 .02</b>	Shaver Socket 220V/110V - 3 Module	<b>2885.00</b>
<b>C5711 .02</b>	Call Bell Station with Register and provision for External Buzzer - 2M	<b>1639.00</b>
<b>C5712 .02</b>	External Buzzer for Call Bell Station - 2 Module	<b>651.00</b>
<b>C5232 .02</b>	“Do Not Disturb” Switch with indicator - 1 Module	<b>515.00</b>
<b>C5233 .02</b>	“Clean My Room” Switch with indicator - 1 Module	<b>515.00</b>
<b>C5906 .02</b>	Volume Control 100 Ohms 1 Watt - 2 Module	<b>893.00</b>
<b>C5262 .02</b>	Bell Switch with “Do Not Disturb” & “Clean My Room” Indicator - 2M	<b>877.00</b>
<b>C5263 .02</b>	Bell Switch with “DND”, “CMR” & Guest is in Indicator - 2M	<b>946.00</b>
<b>C5450 .02</b>	Push Button station (Start - Stop) - 2 Module	<b>720.00</b>
<b>C5460 .02</b>	Curtain Control Switch 6A - 2 Module	<b>799.00</b>



C5729 .02



C5739 .02



C5800 .02  
C5809 .02



C5701 .02



C5700 .02



C5802 .02  
C5803 .02

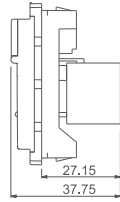

C5725 .02  
C5736 .02



C5836 .02



C5797 .02



C5500 .02



C5798 .02



C5820 .02

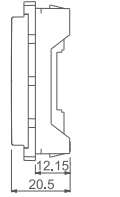

C5936 .02



C5937 .02

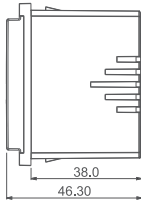

# CUBE Series

## Communiqué & Support Modules Quartz Gray

Cat no.	Description	Price (Rs.)
<b>C5797 .02</b>	Coaxial T.V Socket - 1 Module	<b>277.00</b>
<b>C5725 .02</b>	USB Extension Socket - 1 Module	<b>656.00</b>
<b>C5736 .02</b>	USB Charger Socket Outlet A Type - 2.1 Amps - 1 Module	<b>2998.00</b>
<b>C5836 .02</b>	USB Charger Socket Outlet C Type - 2.1 Amps - 1 Module	<b>3316.00</b>
<b>C5936 .02</b>	USB Charger Socket Outlet A+C Type - 2.1 Amps - 1 Module	<b>3583.00</b>
<b>C5937 .02</b>	USB Charger Socket Outlet C+C Type - 3.1 Amps - 1 Module	<b>4108.00</b>
<b>C5729 .02</b>	Computer Monitor Output Socket - 1 Module	<b>457.00</b>
<b>C5739 .02</b>	HDMI Socket - 1 Module	<b>1787.00</b>
<b>C5800 .02</b>	Telephone Socket RJ-11 Double Line Shuttered - 1 Module	<b>266.00</b>
<b>C5820 .02</b>	Twin Telephone Socket RJ-11 - 1 Module	<b>427.00</b>
<b>C5802 .02</b>	Information Socket 6e - UTP Shuttered - 1 Module	<b>976.00</b>
<b>C5803 .02</b>	Information Socket 6a - UTP Shuttered - 1 Module	<b>1648.00</b>
<b>C5701 .02</b>	Triple RCA Audio Visual Socket - 1 Module	<b>903.00</b>
<b>C5500 .02</b>	Cord Outlet - 1 Module	<b>200.00</b>
<b>C5700 .02</b>	Blanking Plate - 1 Module	<b>71.00</b>
<b>C5798 .02</b>	Audio Port / Jack 3.5mm - 1 Module	<b>523.00</b>
<b>C5809 .02</b>	Fitment for RJ-45 Computer Socket Shuttered - 1 Module	<b>295.00</b>



V5110 .02  
V5210 .02  
V5130 .02  
V5230 .02



V5111 .02  
V5211 .02  
V5131 .02  
V5231 .02



V5140 .02  
V5240 .02  
V5160 .02  
V5180 .02

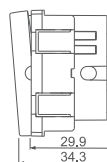

V5141 .02  
V5241 .02  
V5161 .02  
V5261 .02



V5281 .02  
V5191 .02  
V5291 .02  
V5171 .02

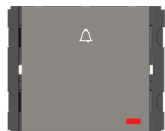

V5340 .02  
V5341 .02

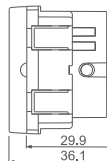

V5901 .02  
V5911 .02



V5913 .02

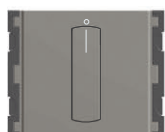

V5900 .02  
V5910 .02  
V5912 .02



Vertical Switches and Vertical Fan Regulators can be mounted on all types of standard Cube Series Plates. Metal Boxes, Frames and Plates need to be fixed in the vertical position as shown here.



# CUBE Series

## Vertical Switches Quartz Gray

Cat no.	Description	Price (Rs.)
<b>V5110 .02</b>	Vertical Switches - 2 Gang - Both switches 6A 1 way - 2 Module	<b>466.00</b>
<b>V5111 .02</b>	Vertical Switches - 2 Gang - Both switches 6A 1 way with indicator - 2M	<b>606.00</b>
<b>V5210 .02</b>	Vertical Switches - 2 Gang - Both switches 6A 2 way - 2 Module	<b>561.00</b>
<b>V5211 .02</b>	Vertical Switches - 2 Gang - Both switches 6A 2 way with indicator - 2M	<b>791.00</b>
<b>V5130 .02</b>	Vertical Switches - 2 Gang - Both switches 16A 1 way - 2 Module	<b>660.00</b>
<b>V5131 .02</b>	Vertical Switches - 2 Gang - Both switches 16A 1 way with indicator - 2M	<b>828.00</b>
<b>V5230 .02</b>	Vertical Switches - 2 Gang - Both switches 16A 2 way - 2 Module	<b>698.00</b>
<b>V5231 .02</b>	Vertical Switches - 2 Gang - Both switches 16A 2 way with indicator - 2M	<b>904.00</b>
<b>V5140 .02</b>	Vertical Palm Switch 6A 1 way Single Pole - 2 Module	<b>255.00</b>
<b>V5141 .02</b>	Vertical Palm Switch 6A 1 way Single Pole with indicator - 2 Module	<b>324.00</b>
<b>V5240 .02</b>	Vertical Palm Switch 6A 2 way Single Pole - 2 Module	<b>289.00</b>
<b>V5241 .02</b>	Vertical Palm Switch 6A 2 way Single Pole with indicator - 2 Module	<b>410.00</b>
<b>V5160 .02</b>	Vertical Palm Switch 16A 1 way Single Pole - 2 Module	<b>337.00</b>
<b>V5161 .02</b>	Vertical Palm Switch 16A 1 way Single Pole with indicator - 2 Module	<b>410.00</b>
<b>V5261 .02</b>	Vertical Palm Switch 16A 2 way Single Pole with indicator - 2 Module	<b>480.00</b>
<b>V5180 .02</b>	Vertical Palm Switch 6A 1 way Double Pole - 2 Module	<b>469.00</b>
<b>V5281 .02</b>	Vertical Palm Switch 6A 2 way Double Pole with indicator - 2 Module	<b>555.00</b>
<b>V5191 .02</b>	Vertical Palm Switch 16A 1 way Double Pole with indicator - 2 Module	<b>655.00</b>
<b>V5291 .02</b>	Vertical Palm Switch 16A 2 way Double Pole with indicator - 2 Module	<b>780.00</b>
<b>V5171 .02</b>	Vertical Palm Switch 25A 1 way Double Pole with indicator - 2 Module	<b>782.00</b>
<b>V5340 .02</b>	Vertical Palm Bell Switch Single Pole - 2 Module	<b>345.00</b>
<b>V5341 .02</b>	Vertical Palm Bell Switch Single Pole with indicator - 2 Module	<b>445.00</b>

51

## Vertical Fan Regulators & Dimmers Quartz Gray

<b>V5900 .02</b>	Vertical Fan Regulator for 80W fan - Step Type with Bar Knob - 2M	<b>1265.00</b>
<b>V5901 .02</b>	Vertical Fan Regulator for 80W fan - Step Type with Round Knob - 2M	<b>1208.00</b>
<b>V5910 .02</b>	Vertical Fan Regulator for 120W fan - Step Type with Bar Knob - 2M	<b>1390.00</b>
<b>V5911 .02</b>	Vertical Fan Regulator for 120W fan - Step Type with Round Knob - 2M	<b>1339.00</b>
<b>V5912 .02</b>	Vertical Fan Regulator for 120W fan - 8-Step Type with Bar Knob - 2M	<b>1445.00</b>
<b>V5913 .02</b>	Vertical Fan Regulator for 120W fan - 8-Step Type with Round Knob-2M	<b>1393.00</b>
<b>V5902 .02</b>	Vertical Dimmer 500 Watts - 2 Module	<b>1016.00</b>



C5110 .17  
C5130 .17  
C5730 .17



C5210 .17  
C5230 .17



C5310 .17



C5441 .17

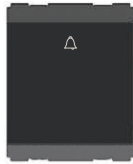

C5340 .17

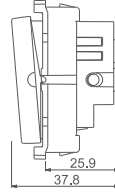

C5111 .17  
C5131 .17  
C5731 .17



C5211 .17  
C5231 .17



C5311 .17



C5431 .17



C5341 .17

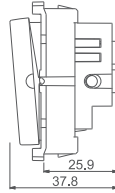

C5140 .17  
C5160 .17



C5180 .17

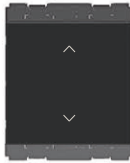

C5240 .17  
C5260 .17



C5280 .17

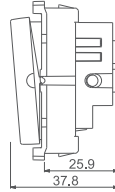

C5141 .17  
C5161 .17



C5191 .17  
C5171 .17

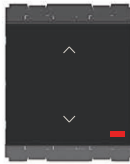

C5241 .17  
C5261 .17



C5281 .17  
C5291 .17

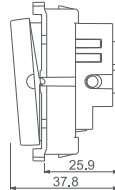

# CUBE Series

## Switches Charcoal Black

Cat no.	Description	Price (Rs.)
<b>C5110 .17</b>	Switch 6A One-way - 1 Module	<b>207.00</b>
<b>C5111 .17</b>	Switch 6A One-way with indicator - 1 Module	<b>331.00</b>
<b>C5210 .17</b>	Switch 6A Two-way - 1 Module	<b>302.00</b>
<b>C5211 .17</b>	Switch 6A Two-way with indicator - 1 Module	<b>441.00</b>
<b>C5130 .17</b>	Switch 16A One-way - 1 Module	<b>358.00</b>
<b>C5131 .17</b>	Switch 16A One-way with indicator - 1 Module	<b>453.00</b>
<b>C5230 .17</b>	Switch 16A Two-way - 1 Module	<b>383.00</b>
<b>C5231 .17</b>	Switch 16A Two-way with indicator - 1 Module	<b>494.00</b>
<b>C5730 .17</b>	Switch 25A One-way - 1 Module	<b>504.00</b>
<b>C5731 .17</b>	Switch 25A One-way with indicator - 1 Module	<b>594.00</b>
<b>C5310 .17</b>	Switch 6A - Bell - 1 Module	<b>319.00</b>
<b>C5311 .17</b>	Switch 6A - Bell with indicator - 1 Module	<b>441.00</b>
<b>C5140 .17</b>	Palm Switch 6A One-way Single Pole - 2 Module	<b>273.00</b>
<b>C5141 .17</b>	Palm Switch 6A One-way Single Pole with indicator - 2 Module	<b>355.00</b>
<b>C5240 .17</b>	Palm Switch 6A Two-way Single Pole - 2 Module	<b>316.00</b>
<b>C5241 .17</b>	Palm Switch 6A Two-way Single Pole with indicator - 2 Module	<b>448.00</b>
<b>C5160 .17</b>	Palm Switch 16A One-way Single Pole - 2 Module	<b>370.00</b>
<b>C5161 .17</b>	Palm Switch 16A One-way Single Pole with indicator - 2 Module	<b>448.00</b>
<b>C5260 .17</b>	Palm Switch 16A Two-way Single Pole - 2 Module	<b>402.00</b>
<b>C5261 .17</b>	Palm Switch 16A Two-way Single Pole with indicator - 2 Module	<b>523.00</b>
<b>C5180 .17</b>	Palm Switch 6A One-way Double Pole - 2 Module	<b>515.00</b>
<b>C5280 .17</b>	Palm Switch 6A Two-way Double Pole - 2 Module	<b>548.00</b>
<b>C5281 .17</b>	Palm Switch 6A Two-way Double Pole with indicator - 2 Module	<b>607.00</b>
<b>C5191 .17</b>	Palm Switch 16A One-way Double Pole with indicator - 2 Module	<b>716.00</b>
<b>C5291 .17</b>	Palm Switch 16A Two-way Double Pole with indicator - 2 Module	<b>852.00</b>
<b>C5171 .17</b>	Palm Switch 25A One-way Double Pole with indicator - 2 Module	<b>855.00</b>
<b>C5340 .17</b>	Palm Bell Switch Single Pole - 2 Module	<b>378.00</b>
<b>C5341 .17</b>	Palm Bell Switch Single Pole with indicator - 2 Module	<b>488.00</b>
<b>C5441 .17</b>	Switch 16A One-way with 'Geyser' Symbol with indicator - 1 Module	<b>468.00</b>
<b>C5431 .17</b>	Switch 6A One-way with 'Fan' or 'Light' or 'Exhaust' symbol - 1 Module	<b>355.00</b>



C2110.17



C2111.17



C2010.17

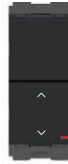

C2011.17



C2130.17

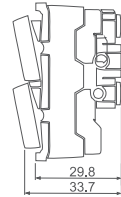

C2131.17



C2030.17



C2031.17



C2140.17



C2141.17

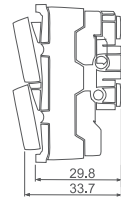

C2040.17

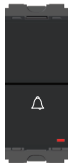

C2041.17

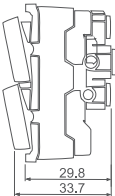

## CUBE Series

### Twin Switches Charcoal Black

Cat no.	Description	Price (Rs.)
<b>C2110 .17</b>	Twin Switch 6A - 2 Gang - Both switches 1 way - 1 Module	<b>651.00</b>
<b>C2111 .17</b>	Twin Switch 6A - 2 Gang - 1 way + 1 way with indicator - 1 Module	<b>983.00</b>
<b>C2010 .17</b>	Twin Switch 6A - 1 Gang - 2 way + Dummy - 1 Module	<b>753.00</b>
<b>C2011 .17</b>	Twin Switch 6A - 1 Gang - 2 way with indicator + Dummy - 1 Module	<b>1056.00</b>
<b>C2130 .17</b>	Twin Switch 16A - 2 Gang - Both switches 1 way - 1 Module	<b>1056.00</b>
<b>C2131 .17</b>	Twin Switch 16A - 2 Gang - 1 way + 1 way with indicator - 1 Module	<b>1325.00</b>
<b>C2030 .17</b>	Twin Switch 16A - 1 Gang - 2 way + Dummy - 1 Module	<b>1002.00</b>
<b>C2031 .17</b>	Twin Switch 16A - 1 Gang - 2 way with indicator + Dummy - 1 Module	<b>1265.00</b>
<b>C2140 .17</b>	Twin Switch 6A - 2 Gang - Both Switches Bell - 1 Module	<b>993.00</b>
<b>C2141 .17</b>	Twin Switch 6A - 2 Gang - 1 Bell + 1 Bell with Indicator - 1 Module	<b>1312.00</b>
<b>C2040 .17</b>	Twin Switch 6A - 1 Gang - 1 Bell + 1 Dummy - 1 Module	<b>800.00</b>
<b>C2041 .17</b>	Twin Switch 6A - 1 Gang - 1 Bell with Indicator + 1 Dummy - 1 Module	<b>1047.00</b>



C5213 .17



C5331 .17



C5332 .17



C5552 .17

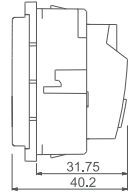

C5212 .17



C5532 .17



C5531 .17



C5752 .17

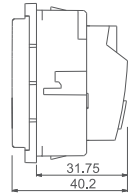

C5010 .17



C5732 .17



C5733 .17

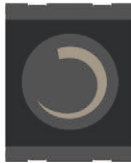

C5902 .17  
C5903 .17  
C5909 .17

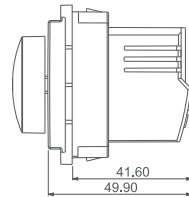

C5904 .17



C5905 .17  
C5908 .17

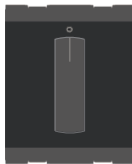

C5900 .17  
C5910 .17  
C5912 .17



C5901 .17  
C5911 .17



C5913 .17

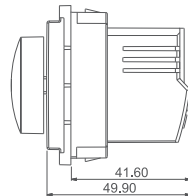

# CUBE Series

## Sockets Charcoal Black

Cat no.	Description	Price (Rs.)
<b>C5213 .17</b>	Socket 6A 3-Pin-only Shuttered - 2 Module (As per Indian Standard)	<b>411.00</b>
<b>C5332 .17</b>	Socket 16A and 6A 3-Pin Shuttered - 2 Module (As per Indian Standard)	<b>532.00</b>
<b>C5552 .17</b>	Socket 16A and 6A 3-Pin Shuttered - 3 Module (As per Indian Standard)	<b>612.00</b>
<b>C5331 .17</b>	Socket 16A 3-Pin-only Shuttered - 2 Module (As per Indian Standard)	<b>516.00</b>
<b>C5212 .17</b>	Socket 6A 3+2 Pin [Round & Flat] Shuttered - 2 Module *	<b>437.00</b>
<b>C5010 .17</b>	Socket 6A 2 Pin [Round & Flat] - 1 Module *	<b>297.00</b>
<b>C5532 .17</b>	Socket 13A International Multi socket Shuttered - 2 Module *	<b>532.00</b>
<b>C5531 .17</b>	Socket 13A 3-Pin Flat-only Socket Shuttered - 2 Module *	<b>504.00</b>
<b>C5732 .17</b>	Socket 25A and 6A 3-Pin Shuttered - 2 Module *	<b>617.00</b>
<b>C5752 .17</b>	Socket 25A and 6A 3-Pin Shuttered - 3 Module *	<b>728.00</b>
<b>C5733 .17</b>	Socket 25A 3-Pin-only Shuttered - 2 Module *	<b>594.00</b>

## Fan Regulators & Dimmers Charcoal Black

<b>C5900 .17</b>	Fan Regulator for 80W fan - Step Type with Bar Knob - 2 Module	<b>1394.00</b>
<b>C5901 .17</b>	Fan Regulator for 80W fan - Step Type with Round Knob - 2 Module	<b>1337.00</b>
<b>C5910 .17</b>	Fan Regulator for 120W fan - Step Type with Bar Knob - 2 Module	<b>1534.00</b>
<b>C5911 .17</b>	Fan Regulator for 120W fan - Step Type with Round Knob - 2 Module	<b>1476.00</b>
<b>C5912 .17</b>	Fan Regulator for 120W fan - 8-Step Type with Bar Knob - 2 Module	<b>1595.00</b>
<b>C5913 .17</b>	Fan Regulator for 120W fan - 8-Step Type with Round Knob - 2 Module	<b>1535.00</b>
<b>C5902 .17</b>	Dimmer 500 Watts - 2 Module	<b>1121.00</b>
<b>C5903 .17</b>	Dimmer 1000 Watts - 2 Module	<b>1569.00</b>
<b>C5904 .17</b>	Fan Regulator Single Module for 80W Fan - Step Type - 1 Module	<b>918.00</b>
<b>C5905 .17</b>	Dimmer 500 Watts - 1 Module	<b>864.00</b>
<b>C5908 .17</b>	Dimmer for LED Lights 100W (3 wire system) - 1 Module	<b>860.00</b>
<b>C5909 .17</b>	Dimmer for LED Lights with Digital Choke 100W (4 wire system) - 2M	<b>1121.00</b>

\* Only for export outside India



C5707 .17  
C5708 .17



C5703 .01  
C5704 .01  
C5705 .01  
C5505 .01



C5715 .17  
C5716 .17



C5727 .17



C5706 .17  
C5709 .17



C5721 .17



C5710 .17

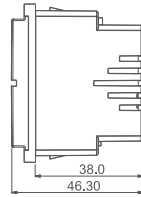



# CUBE Series

## Acoustic & Optical Signaling Charcoal Black

Cat no.	Description	Price (Rs.)
<b>C5707 .17</b>	Electronic Bell - 2 Module	<b>860.00</b>
<b>C5727 .17</b>	Indicator Light - 1 Module	<b>391.00</b>
<b>C5703 .01</b>	Prismatic Overdoor Bulkhead Indicator - White - 2 Module	<b>580.00</b>
<b>C5704 .01</b>	Prismatic Overdoor Bulkhead Indicator - Green - 2 Module	<b>599.00</b>
<b>C5705 .01</b>	Prismatic Overdoor Bulkhead Indicator - Red - 2 Module	<b>599.00</b>
<b>C5505 .01</b>	Prismatic Overdoor Bulkhead Indicator - Resettable - 2 Module	<b>905.00</b>
<b>C5715 .17</b>	Emergency Light - 2 Module	<b>2087.00</b>
<b>C5706 .17</b>	Speaker for audio music circuit - 2 Module	<b>1518.00</b>
<b>C5716 .17</b>	Night Light with switch and dimming option - 2 Module	<b>1324.00</b>
<b>C5721 .17</b>	Step Marker Lamp/ Night Lamp - 2 Module	<b>875.00</b>
<b>C5709 .17</b>	Electronic Buzzer - 2 Module	<b>778.00</b>
<b>C5710 .17</b>	Electronic Buzzer - 1 Module	<b>690.00</b>
<b>C5708 .17</b>	Ultrasonic Mosquito Repellent - 2 Module	<b>1229.00</b>

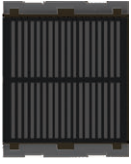

C5712 .17



C5460 .17

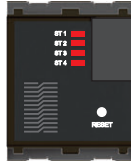

C5711 .17



C5262 .17  
C5263 .17

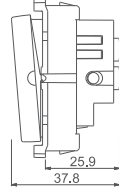

C5450 .17

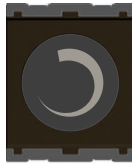

C5906 .17



C5233 .17

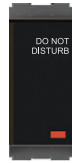

C5232 .17

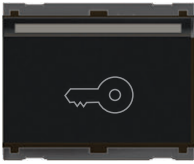
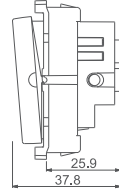

C5718 .17

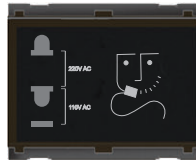

C5723 .17



C5719 .17

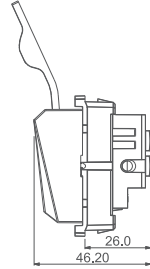

C5717 .17

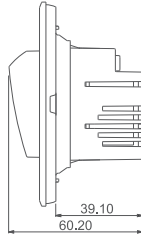

# CUBE Series

## Hospitality Modules Charcoal Black

Cat no.	Description	Price (Rs.)
<b>C5717 .17</b>	25A Smart Card operated Electronic switch in 2 Module with indicator & exit time delay feature including Smart Card - 2 Module	<b>3862.00</b>
<b>C5718 .17</b>	25A Smart Card operated Electronic switch in 3 Module with indicator & exit time delay feature including Smart Card - 3 Module	<b>3586.00</b>
<b>C5724 .17</b>	Smart Card - Customized	<b>271.00</b>
<b>C5719 .17</b>	25A Key Fob Switch Double Pole with indicator - 2 Module	<b>1747.00</b>
<b>C5720 .17</b>	Key Fob - Customized	<b>278.00</b>
<b>C5723 .17</b>	Shaver Socket 220V/110V - 3 Module	<b>3404.00</b>
<b>C5711 .17</b>	Call Bell Station with Register and provision for External Buzzer - 2M	<b>1928.00</b>
<b>C5712 .17</b>	External Buzzer for Call Bell Station - 2 Module	<b>708.00</b>
<b>C5232 .17</b>	“Do Not Disturb” Switch with indicator - 1 Module	<b>554.00</b>
<b>C5233 .17</b>	“Clean My Room” Switch with indicator - 1 Module	<b>554.00</b>
<b>C5906 .17</b>	Volume Control 100 Ohms 1 Watt - 2 Module	<b>923.00</b>
<b>C5262 .17</b>	Bell Switch with “Do Not Disturb” & “Clean My Room” Indicator - 2M	<b>897.00</b>
<b>C5263 .17</b>	Bell Switch with “DND”, “CMR” & Guest is in Indicator - 2M	<b>1023.00</b>
<b>C5450 .17</b>	Push Button station (Start - Stop) - 2 Module	<b>774.00</b>
<b>C5460 .17</b>	Curtain Control Switch 6A - 2 Module	<b>855.00</b>



C5729 .17



C5739 .17



C5800 .17  
C5809 .17



C5701 .17



C5700 .17



C5802 .17  
C5803 .17

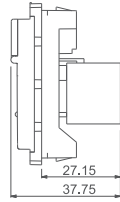

C5725 .17  
C5736 .17



C5836 .17



C5797 .17



C5500 .17



C5798 .17



C5820 .17

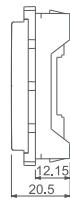

62



C5936 .17



C5937 .17



C5110 .20



C5111 .20  
C5131 .20  
C5731 .20



C5171 .20

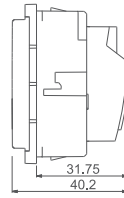

C5212 .20

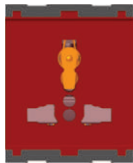

C5532 .20

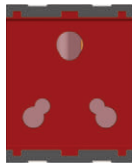

C5332 .20

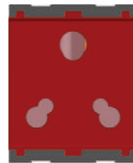

C5732 .20



# CUBE Series

## Communiqué & Support Modules Charcoal Black

Cat no.	Description	Price (Rs.)
<b>C5797 .17</b>	Coaxial T.V Socket - 1 Module	<b>300.00</b>
<b>C5725 .17</b>	USB Extension Socket - 1 Module	<b>712.00</b>
<b>C5736 .17</b>	USB Charger Socket Outlet A Type - 2.1 Amps - 1 Module	<b>3248.00</b>
<b>C5836 .17</b>	USB Charger Socket Outlet C Type - 2.1 Amps - 1 Module	<b>3592.00</b>
<b>C5936 .17</b>	USB Charger Socket Outlet A+C Type - 2.1 Amps - 1 Module	<b>3882.00</b>
<b>C5937 .17</b>	USB Charger Socket Outlet C+C Type - 3.1 Amps - 1 Module	<b>4448.00</b>
<b>C5729 .17</b>	Computer Monitor Output Socket - 1 Module	<b>495.00</b>
<b>C5739 .17</b>	HDMI Socket - 1 Module	<b>1936.00</b>
<b>C5800 .17</b>	Telephone Socket RJ-11 Double Line Shuttered - 1 Module	<b>287.00</b>
<b>C5820 .17</b>	Twin Telephone Socket RJ-11 - 1 Module	<b>463.00</b>
<b>C5802 .17</b>	Information Socket 6e - UTP Shuttered - 1 Module	<b>1061.00</b>
<b>C5803 .17</b>	Information Socket 6a - UTP Shuttered - 1 Module	<b>1787.00</b>
<b>C5701 .17</b>	Triple RCA Audio Visual Socket - 1 Module	<b>981.00</b>
<b>C5500 .17</b>	Cord Outlet - 1 Module	<b>218.00</b>
<b>C5700 .17</b>	Blanking Plate - 1 Module	<b>78.00</b>
<b>C5798 .17</b>	Audio Port / Jack 3.5mm - 1 Module	<b>568.00</b>
<b>C5809 .17</b>	Fitment for RJ-45 Computer Socket Shuttered - 1 Module	<b>320.00</b>

63

## Dedicated Modules Scarlet Red

<b>C5110 .20</b>	Switch 6A One-way - 1 Module	<b>252.00</b>
<b>C5111 .20</b>	Switch 6A One-way with indicator - 1 Module	<b>331.00</b>
<b>C5131 .20</b>	Switch 16A One-way with indicator - 1 Module	<b>453.00</b>
<b>C5731 .20</b>	Switch 25A One-way with indicator - 1 Module	<b>594.00</b>
<b>C5171 .20</b>	Palm Switch 25A One-way Double Pole with indicator - 2 Module	<b>855.00</b>
<b>C5212 .20</b>	Socket 6A 3+2 Pin [Round & Flat] Shuttered - 2 Module *	<b>437.00</b>
<b>C5532 .20</b>	Socket 13A International Multi socket Shuttered - 2 Module *	<b>532.00</b>
<b>C5332 .20</b>	Socket 16A and 6A 3-Pin Shuttered - 2 Module (As per Indian Standard)	<b>532.00</b>
<b>C5732 .20</b>	Socket 25A and 6A 3-Pin Shuttered - 2 Module *	<b>616.00</b>

\* Only for export outside India



V5110 .17  
V5210 .17  
V5130 .17  
V5230 .17



V5111 .17  
V5211 .17  
V5131 .17  
V5231 .17



V5140 .17  
V5240 .17  
V5160 .17  
V5180 .17

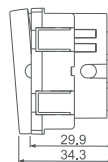

V5141 .17  
V5241 .17  
V5161 .17  
V5261 .17



V5281 .17  
V5191 .17  
V5291 .17  
V5171 .17



V5340 .17  
V5341 .17

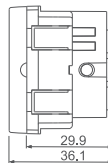

64



V5901 .17  
V5911 .17

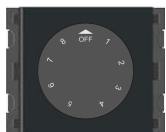

V5913 .17



V5900 .17  
V5910 .17  
V5912 .17

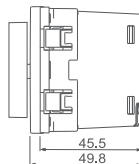

Vertical Switches and Vertical Fan Regulators can be mounted on all types of standard Cube Series Plates. Metal Boxes, Frames and Plates need to be fixed in the vertical position as shown here.

## CUBE Series

### Vertical Switches Charcoal Black

Cat no.	Description	Price (Rs.)
<b>V5110 .17</b>	Vertical Switches - 2 Gang - Both switches 6A 1 way - 2 Module	<b>504.00</b>
<b>V5111 .17</b>	Vertical Switches - 2 Gang - Both switches 6A 1 way with indicator - 2M	<b>660.00</b>
<b>V5210 .17</b>	Vertical Switches - 2 Gang - Both switches 6A 2 way - 2 Module	<b>614.00</b>
<b>V5211 .17</b>	Vertical Switches - 2 Gang - Both switches 6A 2 way with indicator - 2M	<b>879.00</b>
<b>V5130 .17</b>	Vertical Switches - 2 Gang - Both switches 16A 1 way - 2 Module	<b>726.00</b>
<b>V5131 .17</b>	Vertical Switches - 2 Gang - Both switches 16A 1 way with indicator - 2M	<b>904.00</b>
<b>V5230 .17</b>	Vertical Switches - 2 Gang - Both switches 16A 2 way - 2 Module	<b>765.00</b>
<b>V5231 .17</b>	Vertical Switches - 2 Gang - Both switches 16A 2 way with indicator - 2M	<b>988.00</b>
<b>V5140 .17</b>	Vertical Palm Switch 6A 1 way Single Pole - 2 Module	<b>279.00</b>
<b>V5141 .17</b>	Vertical Palm Switch 6A 1 way Single Pole with indicator - 2 Module	<b>355.00</b>
<b>V5240 .17</b>	Vertical Palm Switch 6A 2 way Single Pole - 2 Module	<b>317.00</b>
<b>V5241 .17</b>	Vertical Palm Switch 6A 2 way Single Pole with indicator - 2 Module	<b>448.00</b>
<b>V5160 .17</b>	Vertical Palm Switch 16A 1 way Single Pole - 2 Module	<b>369.00</b>
<b>V5161 .17</b>	Vertical Palm Switch 16A 1 way Single Pole with indicator - 2 Module	<b>448.00</b>
<b>V5261 .17</b>	Vertical Palm Switch 16A 2 way Single Pole with indicator - 2 Module	<b>523.00</b>
<b>V5180 .17</b>	Vertical Palm Switch 6A 1 way Double Pole - 2 Module	<b>515.00</b>
<b>V5281 .17</b>	Vertical Palm Switch 6A 2 way Double Pole with indicator - 2 Module	<b>607.00</b>
<b>V5191 .17</b>	Vertical Palm Switch 16A 1 way Double Pole with indicator - 2 Module	<b>716.00</b>
<b>V5291 .17</b>	Vertical Palm Switch 16A 2 way Double Pole with indicator - 2 Module	<b>852.00</b>
<b>V5171 .17</b>	Vertical Palm Switch 25A 1 way Double Pole with indicator - 2 Module	<b>855.00</b>
<b>V5340 .17</b>	Vertical Palm Bell Switch Single Pole - 2 Module	<b>378.00</b>
<b>V5341 .17</b>	Vertical Palm Bell Switch Single Pole with indicator - 2 Module	<b>488.00</b>

65

### Vertical Fan Rgulators & Dimmers Charcoal Black

<b>V5900 .17</b>	Vertical Fan Regulator for 80W fan - Step Type with Bar Knob - 2M	<b>1394.00</b>
<b>V5901 .17</b>	Vertical Fan Regulator for 80W fan - Step Type with Round Knob - 2M	<b>1337.00</b>
<b>V5910 .17</b>	Vertical Fan Regulator for 120W fan - Step Type with Bar Knob - 2M	<b>1532.00</b>
<b>V5911 .17</b>	Vertical Fan Regulator for 120W fan - Step Type with Round Knob - 2M	<b>1478.00</b>
<b>V5912 .17</b>	Vertical Fan Regulator for 120W fan - 8-Step Type with Bar Knob - 2M	<b>1595.00</b>
<b>V5913 .17</b>	Vertical Fan Regulator for 120W fan - 8-Step Type with Round Knob-2M	<b>1535.00</b>
<b>V5902 .17</b>	Vertical Dimmer 500 Watts - 2 Module	<b>1121.00</b>



C5101 .01 C5101 .16  
 C5101 .02 C5101 .17  
 C5101 .03 C5101 .25



C5102 .01 C5102 .16  
 C5102 .02 C5102 .17  
 C5102 .03 C5102 .25



C5103 .01 C5103 .16  
 C5103 .02 C5103 .17  
 C5103 .03 C5103 .25

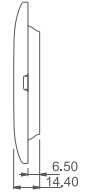

C5104 .01 C5104 .16  
 C5104 .02 C5104 .17  
 C5104 .03 C5104 .25



C5106 .01 C5106 .16  
 C5106 .02 C5106 .17  
 C5106 .03 C5106 .25

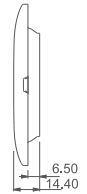

66



C5108 .01 C5108 .16  
 C5108 .02 C5108 .17  
 C5108 .03 C5108 .25

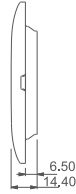

C5109 .01 C5109 .16  
 C5109 .02 C5109 .17  
 C5109 .03 C5109 .25

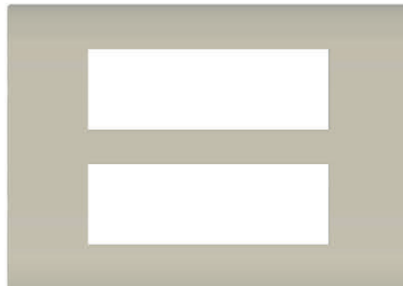

C5112 .01 C5112 .16  
 C5112 .02 C5112 .17  
 C5112 .03 C5112 .25

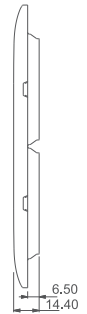

Image for 14M Plate and 21M Plate are not shown here



# CUBE Series

## Smart plates with frames Frost White, Quartz Gray and Ice Silver

Description	Frost White		Quartz Gray		Ice Silver	
	Cat no.	Price	Cat no.	Price	Cat no.	Price
1M Plate	C5101 .01	153.00	C5101 .02	241.00	C5101 .03	241.00
2M Plate	C5102 .01	161.00	C5102 .02	254.00	C5102 .03	254.00
3M Plate	C5103 .01	176.00	C5103 .02	277.00	C5103 .03	277.00
4M Plate	C5104 .01	187.00	C5104 .02	296.00	C5104 .03	296.00
6M Plate	C5106 .01	335.00	C5106 .02	534.00	C5106 .03	534.00
8M Plate	C5108 .01	370.00	C5108 .02	588.00	C5108 .03	588.00
8M (V) Plate	C5109 .01	432.00	C5109 .02	684.00	C5109 .03	684.00
12M Plate	C5112 .01	524.00	C5112 .02	832.00	C5112 .03	832.00
14M Plate	C5114 .01	599.00	C5114 .02	958.00	C5114 .03	958.00
21M Plate	C5121 .01	757.00	C5121 .02	1387.00	C5121 .03	1387.00

67

## Smart plates with frames Matt Gold, Charcoal Black and Cocoa Brown

Description	Matt Gold		Charcoal Black		Cocoa Brown	
	Cat no.	Price	Cat no.	Price	Cat no.	Price
1M Plate	C5101 .16	289.00	C5101 .17	292.00	C5101 .25	304.00
2M Plate	C5102 .16	306.00	C5102 .17	308.00	C5102 .25	320.00
3M Plate	C5103 .16	333.00	C5103 .17	336.00	C5103 .25	349.00
4M Plate	C5104 .16	356.00	C5104 .17	359.00	C5104 .25	373.00
6M Plate	C5106 .16	641.00	C5106 .17	647.00	C5106 .25	673.00
8M Plate	C5108 .16	706.00	C5108 .17	711.00	C5108 .25	740.00
8M (V) Plate	C5109 .16	822.00	C5109 .17	828.00	C5109 .25	861.00
12M Plate	C5112 .16	998.00	C5112 .17	1008.00	C5112 .25	1048.00
14M Plate	C5114 .16	1150.00	C5114 .17	1160.00	C5114 .25	1206.00
21M Plate	C5121 .16	1665.00	C5121 .17	1680.00	C5121 .25	1747.00



C5401 .01 C5401 .16  
 C5401 .02 C5401 .17  
 C5401 .03 C5401 .25



C5402 .01 C5402 .16  
 C5402 .02 C5402 .17  
 C5402 .03 C5402 .25



C5403 .01 C5403 .16  
 C5403 .02 C5403 .17  
 C5403 .03 C5403 .25

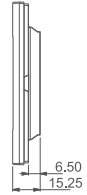

C5404 .01 C5404 .16  
 C5404 .02 C5404 .17  
 C5404 .03 C5404 .25



C5406 .01 C5406 .16  
 C5406 .02 C5406 .17  
 C5406 .03 C5406 .25

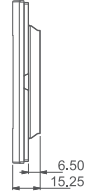

68

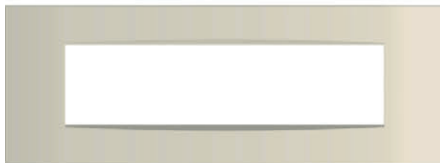

C5408 .01 C5408 .16  
 C5408 .02 C5408 .17  
 C5408 .03 C5408 .25

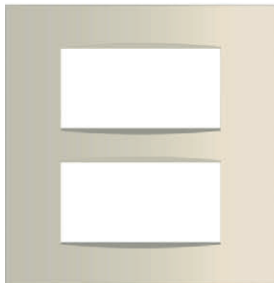
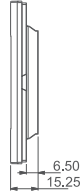

C5409 .01 C5409 .16  
 C5409 .02 C5409 .17  
 C5409 .03 C5409 .25



C5412 .01 C5412 .16  
 C5412 .02 C5412 .17  
 C5412 .03 C5412 .25

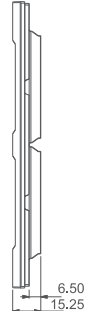

Images for 14M Plate, 16M Plate and 21M Plate are not shown here

# CUBE Series

## Vector plates with frames Frost White, Quartz Gray and Ice Silver

Description	Frost White		Quartz Gray		Ice Silver	
	Cat no.	Price	Cat no.	Price	Cat no.	Price
1M Plate	C5401 .01	166.00	C5401 .02	253.00	C5401 .03	253.00
2M Plate	C5402 .01	173.00	C5402 .02	266.00	C5402 .03	266.00
3M Plate	C5403 .01	189.00	C5403 .02	293.00	C5403 .03	293.00
4M Plate	C5404 .01	202.00	C5404 .02	312.00	C5404 .03	312.00
6M Plate	C5406 .01	364.00	C5406 .02	561.00	C5406 .03	561.00
8M Plate	C5408 .01	400.00	C5408 .02	618.00	C5408 .03	618.00
8M (V) Plate	C5409 .01	466.00	C5409 .02	719.00	C5409 .03	719.00
12M Plate	C5412 .01	569.00	C5412 .02	874.00	C5412 .03	874.00
14M Plate	C5414 .01	662.00	C5414 .02	1019.00	C5414 .03	1019.00
16M Plate	C5416 .01	697.00	C5416 .02	1073.00	C5416 .03	1073.00
21M Plate	C5421 .01	836.00	C5421 .02	1478.00	C5421 .03	1478.00

69

## Vector plates with frames Matt Gold, Charcoal Black and Cocoa Brown

Description	Matt Gold		Charcoal Black		Cocoa Brown	
	Cat no.	Price	Cat no.	Price	Cat no.	Price
1M Plate	C5401 .16	304.00	C5401 .17	312.00	C5401 .25	312.00
2M Plate	C5402 .16	338.00	C5402 .17	350.00	C5402 .25	350.00
3M Plate	C5403 .16	363.00	C5403 .17	380.00	C5403 .25	380.00
4M Plate	C5404 .16	392.00	C5404 .17	409.00	C5404 .25	409.00
6M Plate	C5406 .16	673.00	C5406 .17	698.00	C5406 .25	698.00
8M Plate	C5408 .16	743.00	C5408 .17	753.00	C5408 .25	753.00
8M (V) Plate	C5409 .16	861.00	C5409 .17	908.00	C5409 .25	908.00
12M Plate	C5412 .16	1049.00	C5412 .17	1085.00	C5412 .25	1085.00
14M Plate	C5414 .16	1224.00	C5414 .17	1248.00	C5414 .25	1248.00
16M Plate	C5416 .16	1290.00	C5416 .17	1363.00	C5416 .25	1363.00
21M Plate	C5421 .16	1773.00	C5421 .17	1866.00	C5421 .25	1866.00



C6401 .01 C6401 .03  
C6401 .02 C6401 .16



C6402 .01 C6402 .03  
C6402 .02 C6402 .16



C6403 .01 C6403 .03  
C6403 .02 C6403 .16

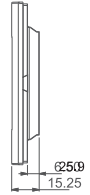

C6404 .01 C6404 .03  
C6404 .02 C6404 .16



C6406 .01 C6406 .03  
C6406 .02 C6406 .16

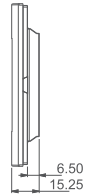

70



C6408 .01 C6408 .03  
C6408 .02 C6408 .16

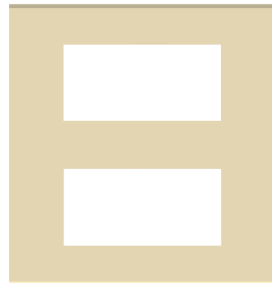
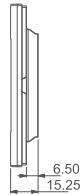

C6409 .01 C6409 .03  
C6409 .02 C6409 .16



C6412 .01 C6412 .03  
C6412 .02 C6412 .16

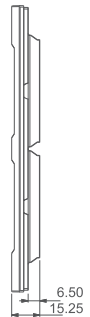

Images for 14M Plate, 16M Plate and 21M Plate are not shown here

# CUBE Series

## Flat'5 plates with frames Frost White and Quartz Gray

Description	Cat no.	Price	Frost White		Quartz Gray	
			Cat no.	Price	Cat no.	Price
1M Plate - for 75mm x 75mm box (3x3)			<b>C6401 .01</b>	<b>227.00</b>	<b>C6401 .02</b>	<b>401.00</b>
2M Plate - for 75mm x 75mm box (3x3)			<b>C6402 .01</b>	<b>240.00</b>	<b>C6402 .02</b>	<b>436.00</b>
3M Plate - for 100mm x 75mm box (4x3)			<b>C6403 .01</b>	<b>266.00</b>	<b>C6403 .02</b>	<b>482.00</b>
4M Plate - for 135mm x 75mm box (5x3)			<b>C6404 .01</b>	<b>284.00</b>	<b>C6404 .02</b>	<b>512.00</b>
6M Plate - for 210mm x 75mm box (8x3)			<b>C6406 .01</b>	<b>511.00</b>	<b>C6406 .02</b>	<b>926.00</b>
8M Plate - for 230/210 x 75mm box (9x3 or 8x3)			<b>C6408 .01</b>	<b>568.00</b>	<b>C6408 .02</b>	<b>1027.00</b>
8M (V) Plate - for 135mm x 140mm box (5x5)			<b>C6409 .01</b>	<b>755.00</b>	<b>C6409 .02</b>	<b>1325.00</b>
12M Plate - for 140mm x 210mm box (8x6)			<b>C6412 .01</b>	<b>873.00</b>	<b>C6412 .02</b>	<b>1583.00</b>
14M Plate - for 140mm x 210mm box (8x6)			<b>C6414 .01</b>	<b>1029.00</b>	<b>C6414 .02</b>	<b>1863.00</b>
16M Plate - for 230x145mm box (10x6 or 9x6)			<b>C6416 .01</b>	<b>1152.00</b>	<b>C6416 .02</b>	<b>2092.00</b>
21M Plate - for 210mm x 210mm box (8x8)			<b>C6421 .01</b>	<b>1319.00</b>	<b>C6421 .02</b>	<b>2403.00</b>

71

## Flat'5 plates with frames Ice Silver and Matt Gold

Description	Cat no.	Price	Ice Silver		Matt Gold	
			Cat no.	Price	Cat no.	Price
1M Plate - for 75mm x 75mm box (3x3)			<b>C6401 .03</b>	<b>401.00</b>	<b>C6401 .16</b>	<b>483.00</b>
2M Plate - for 75mm x 75mm box (3x3)			<b>C6402 .03</b>	<b>436.00</b>	<b>C6402 .16</b>	<b>553.00</b>
3M Plate - for 100mm x 75mm box (4x3)			<b>C6403 .03</b>	<b>482.00</b>	<b>C6403 .16</b>	<b>599.00</b>
4M Plate - for 135mm x 75mm box (5x3)			<b>C6404 .03</b>	<b>512.00</b>	<b>C6404 .16</b>	<b>644.00</b>
6M Plate - for 210mm x 75mm box (8x3)			<b>C6406 .03</b>	<b>926.00</b>	<b>C6406 .16</b>	<b>1112.00</b>
8M Plate - for 230/210 x 75mm box (9x3 or 8x3)			<b>C6408 .03</b>	<b>1027.00</b>	<b>C6408 .16</b>	<b>1234.00</b>
8M (V) Plate - for 135mm x 140mm box (5x5)			<b>C6409 .03</b>	<b>1325.00</b>	<b>C6409 .16</b>	<b>1591.00</b>
12M Plate - for 140mm x 210mm box (8x6)			<b>C6412 .03</b>	<b>1583.00</b>	<b>C6412 .16</b>	<b>1902.00</b>
14M Plate - for 140mm x 210mm box (8x6)			<b>C6414 .03</b>	<b>1863.00</b>	<b>C6414 .16</b>	<b>2237.00</b>
16M Plate - for 230x145mm box (10x6 or 9x6)			<b>C6416 .03</b>	<b>2092.00</b>	<b>C6416 .16</b>	<b>2514.00</b>
21M Plate - for 210mm x 210mm box (8x8)			<b>C6421 .03</b>	<b>2403.00</b>	<b>C6421 .16</b>	<b>2885.00</b>



C6401 .17 C6401 .26  
C6401 .25



C6402 .17 C6402 .26  
C6402 .25



C6403 .17 C6403 .26  
C6403 .25

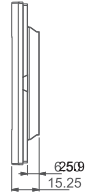

C6404 .17 C6404 .26  
C6404 .25



C6406 .17 C6406 .26  
C6406 .25

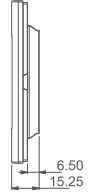

C6408 .17 C6408 .26  
C6408 .25

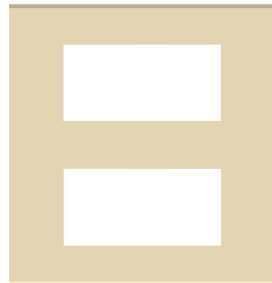
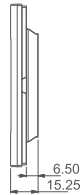

C6409 .17 C6409 .26  
C6409 .25



C6412 .17 C6412 .26  
C6412 .25

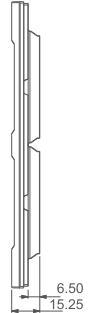

Images for 14M Plate, 16M Plate and 21M Plate are not shown here

# CUBE Series

## Flat 5 plates with frames Charcoal Black and Cocoa Brown

	Charcoal Black		Cocoa Brown	
	Cat no.	Price	Cat no.	Price
1M Plate - for 75mm x 75mm box (3x3)	<b>C6401 .17</b>	<b>498.00</b>	<b>C6401 .25</b>	<b>498.00</b>
2M Plate - for 75mm x 75mm box (3x3)	<b>C6402 .17</b>	<b>573.00</b>	<b>C6402 .25</b>	<b>573.00</b>
3M Plate - for 100mm x 75mm box (4x3)	<b>C6403 .17</b>	<b>625.00</b>	<b>C6403 .25</b>	<b>625.00</b>
4M Plate - for 135mm x 75mm box (5x3)	<b>C6404 .17</b>	<b>671.00</b>	<b>C6404 .25</b>	<b>671.00</b>
6M Plate - for 210mm x 75mm box (8x3)	<b>C6406 .17</b>	<b>1154.00</b>	<b>C6406 .25</b>	<b>1154.00</b>
8M Plate - for 230/210 x 75mm box (9x3 or 8x3)	<b>C6408 .17</b>	<b>1252.00</b>	<b>C6408 .25</b>	<b>1252.00</b>
8M (V) Plate - for 135mm x 140mm box (5x5)	<b>C6409 .17</b>	<b>1677.00</b>	<b>C6409 .25</b>	<b>1677.00</b>
12M Plate - for 140mm x 210mm box (8x6)	<b>C6412 .17</b>	<b>1965.00</b>	<b>C6412 .25</b>	<b>1965.00</b>
14M Plate - for 140mm x 210mm box (8x6)	<b>C6414 .17</b>	<b>2280.00</b>	<b>C6414 .25</b>	<b>2280.00</b>
16M Plate - for 230x145mm box (10x6 or 9x6)	<b>C6416 .17</b>	<b>2659.00</b>	<b>C6416 .25</b>	<b>2659.00</b>
21M Plate - for 210mm x 210mm box (8x8)	<b>C6421 .17</b>	<b>3035.00</b>	<b>C6421 .25</b>	<b>3035.00</b>

73

## Flat 5 plates with frames Silver Dust

Description	Silver Dust	
	Cat no.	Price
1M Plate - for 75mm x 75mm box (3x3)	<b>C6401 .26</b>	<b>498.00</b>
2M Plate - for 75mm x 75mm box (3x3)	<b>C6402 .26</b>	<b>573.00</b>
3M Plate - for 100mm x 75mm box (4x3)	<b>C6403 .26</b>	<b>625.00</b>
4M Plate - for 135mm x 75mm box (5x3)	<b>C6404 .26</b>	<b>671.00</b>
6M Plate - for 210mm x 75mm box (8x3)	<b>C6406 .26</b>	<b>1154.00</b>
8M Plate - for 230/210 x 75mm box (9x3 or 8x3)	<b>C6408 .26</b>	<b>1252.00</b>
8M (V) Plate - for 135mm x 140mm box (5x5)	<b>C6409 .26</b>	<b>1677.00</b>
12M Plate - for 140mm x 210mm box (8x6)	<b>C6412 .26</b>	<b>1965.00</b>
14M Plate - for 140mm x 210mm box (8x6)	<b>C6414 .26</b>	<b>2280.00</b>
16M Plate - for 230x145mm box (10x6 or 9x6)	<b>C6416 .26</b>	<b>2659.00</b>
21M Plate - for 210mm x 210mm box (8x8)	<b>C6421 .26</b>	<b>3035.00</b>

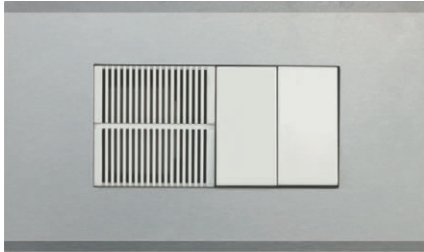

CA304 .04  
Solid Aluminum Plate - 4 Module  
natural finish mounted with  
modules C5706 .01 and C5110 .01

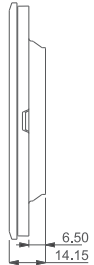

CA304 .05  
Solid Aluminum Plate - 4 Module  
black finish mounted with  
C5706 .02, C5701 .02, C5726 .02

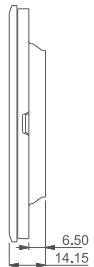

CA304 .14  
Solid Aluminum Plate - 4 Module  
Dark Bronze mounted with  
modules C5110 .02 and C5721 .02

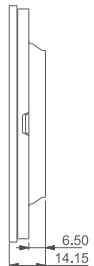



# CUBE Series

## Solid Aluminum Plates with frames Natural & Black

Description	Aluminum Natural		Aluminum Black	
	Cat no.	Price	Cat no.	Price
1M Plate - for 75mm x 75mm box (3x3)	<b>CA301 .04</b>	<b>1761.00</b>	<b>CA301 .05</b>	<b>1761.00</b>
2M Plate - for 75mm x 75mm box (3x3)	<b>CA302 .04</b>	<b>1786.00</b>	<b>CA302 .05</b>	<b>1786.00</b>
3M Plate - for 100mm x 75mm box (4x3)	<b>CA303 .04</b>	<b>1894.00</b>	<b>CA303 .05</b>	<b>1894.00</b>
4M Plate - for 135mm x 75mm box (5x3)	<b>CA304 .04</b>	<b>2128.00</b>	<b>CA304 .05</b>	<b>2128.00</b>
6M Plate - for 210mm x 75mm box (8x3)	<b>CA306 .04</b>	<b>2330.00</b>	<b>CA306 .05</b>	<b>2330.00</b>
8M Plate - for 230/210 x 75mm box (9x3 or 8x3)	<b>CA308 .04</b>	<b>2523.00</b>	<b>CA308 .05</b>	<b>2523.00</b>
8M (V) Plate - for 135mm x 140mm box (5x5)	<b>CA309 .04</b>	<b>4592.00</b>	<b>CA309 .05</b>	<b>4592.00</b>
12M Plate - for 140mm x 210mm box (8x6)	<b>CA312 .04</b>	<b>5776.00</b>	<b>CA312 .05</b>	<b>5776.00</b>
14M Plate - for 140mm x 210mm box (8x6)	<b>CA314 .04</b>	<b>6283.00</b>	<b>CA314 .05</b>	<b>6283.00</b>
16M Plate - for 230x145mm box (10x6 or 9x6)	<b>CA316 .04</b>	<b>9400.00</b>	<b>CA316 .05</b>	<b>9400.00</b>
21M Plate - for 210mm x 210mm box (8x8)	<b>CA321 .04</b>	<b>12485.00</b>	<b>CA321 .05</b>	<b>12485.00</b>

75

## Solid Aluminum Plates with frames Dark Bronze

Description	Dark Bronze	
	Cat no.	Price
1M Plate - for 75mm x 75mm box (3x3)	<b>CA301 .14</b>	<b>1936.00</b>
2M Plate - for 75mm x 75mm box (3x3)	<b>CA302 .14</b>	<b>1966.00</b>
3M Plate - for 100mm x 75mm box (4x3)	<b>CA303 .14</b>	<b>2084.00</b>
4M Plate - for 135mm x 75mm box (5x3)	<b>CA304 .14</b>	<b>2341.00</b>
6M Plate - for 210mm x 75mm box (8x3)	<b>CA306 .14</b>	<b>2563.00</b>
8M Plate - for 230/210 x 75mm box (9x3 or 8x3)	<b>CA308 .14</b>	<b>2778.00</b>
8M (V) Plate - for 135mm x 140mm box (5x5)	<b>CA309 .14</b>	<b>5051.00</b>
12M Plate - for 140mm x 210mm box (8x6)	<b>CA312 .14</b>	<b>6355.00</b>
14M Plate - for 140mm x 210mm box (8x6)	<b>CA314 .14</b>	<b>6877.00</b>
16M Plate - for 230x145mm box (10x6 or 9x6)	<b>CA316 .14</b>	<b>10342.00</b>
21M Plate - for 210mm x 210mm box (8x8)	<b>CA321 .14</b>	<b>13735.00</b>

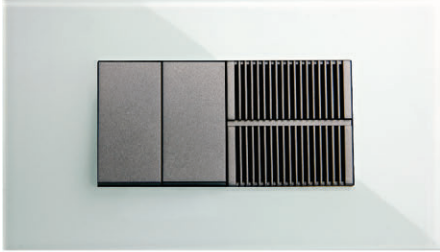

CG304 .08  
Solid Glass Plate - 4 Module  
ice white finish mounted with  
modules C5110 .02 and C5706 .02

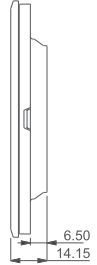

CG304 .09  
Solid Glass Plate - 4 Module  
metal gray finish mounted with  
modules C5110 .01

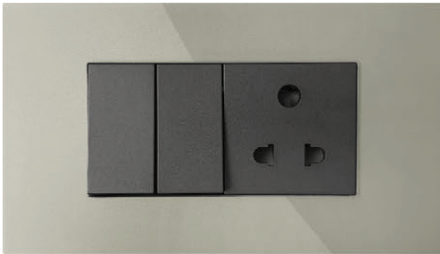
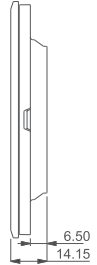

CG304 .18  
Solid Glass Plate - 4 Module  
Smoked Silver mounted with  
modules C5110 .02 and C5212 .02

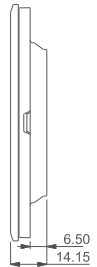

CG304 .19  
Solid Glass Plate - 4 Module  
Solid Black mounted with  
modules C5110 .02 and C5721 .02

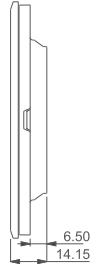

# CUBE Series

## Solid Glass Plates with frames Ice White & Metal Gray

Description	Ice White		Metal Gray	
	Cat no.	Price	Cat no.	Price
1M Plate - for 75mm x 75mm box (3x3)	<b>CG301 .08</b>	<b>1260.00</b>	<b>CG301 .09</b>	<b>1260.00</b>
2M Plate - for 75mm x 75mm box (3x3)	<b>CG302 .08</b>	<b>1280.00</b>	<b>CG302 .09</b>	<b>1280.00</b>
3M Plate - for 100mm x 75mm box (4x3)	<b>CG303 .08</b>	<b>1356.00</b>	<b>CG303 .09</b>	<b>1356.00</b>
4M Plate - for 135mm x 75mm box (5x3)	<b>CG304 .08</b>	<b>1524.00</b>	<b>CG304 .09</b>	<b>1524.00</b>
6M Plate - for 210mm x 75mm box (8x3)	<b>CG306 .08</b>	<b>1668.00</b>	<b>CG306 .09</b>	<b>1668.00</b>
8M Plate - for 230/210 x 75 mm x (9x3 or 8x3)	<b>CG308 .08</b>	<b>1807.00</b>	<b>CG308 .09</b>	<b>1807.00</b>
8M (V) Plate - for 135mm x 140mm box (5x5)	<b>CG309 .08</b>	<b>2208.00</b>	<b>CG309 .09</b>	<b>2208.00</b>
12M Plate - for 140mm x 210mm box (8x6)	<b>CG312 .08</b>	<b>2809.00</b>	<b>CG312 .09</b>	<b>2809.00</b>
14M Plate - for 140mm x 210mm box (8x6)	<b>CG314 .08</b>	<b>3492.00</b>	<b>CG314 .09</b>	<b>3492.00</b>
16M Plate - for 230x145mm box (10x6 or 9x6)	<b>CG316 .08</b>	<b>4966.00</b>	<b>CG316 .09</b>	<b>4966.00</b>
21M Plate - for 210mm x 210mm box (8x8)	<b>CG321 .08</b>	<b>6437.00</b>	<b>CG321 .09</b>	<b>6437.00</b>

77

## Solid Glass Plates with frames Smoked Silver, Solid Black & Ultra White

Description	Smoked Silver		Solid Black		Ultra White	
	Cat no.	Price	Cat no.	Price	Cat no.	Price
1M Plate	<b>CG301 .18</b>	<b>1260.00</b>	<b>CG301 .19</b>	<b>1260.00</b>	<b>CG301 .38</b>	<b>1722.00</b>
2M Plate	<b>CG302 .18</b>	<b>1280.00</b>	<b>CG302 .19</b>	<b>1280.00</b>	<b>CG302 .38</b>	<b>1773.00</b>
3M Plate	<b>CG303 .18</b>	<b>1356.00</b>	<b>CG303 .19</b>	<b>1356.00</b>	<b>CG303 .38</b>	<b>1853.00</b>
4M Plate	<b>CG304 .18</b>	<b>1524.00</b>	<b>CG304 .19</b>	<b>1524.00</b>	<b>CG304 .38</b>	<b>2082.00</b>
6M Plate	<b>CG306 .18</b>	<b>1668.00</b>	<b>CG306 .19</b>	<b>1668.00</b>	<b>CG306 .38</b>	<b>2286.00</b>
8M Plate	<b>CG308 .18</b>	<b>1807.00</b>	<b>CG308 .19</b>	<b>1807.00</b>	<b>CG308 .38</b>	<b>2485.00</b>
8M (V) Plate	<b>CG309 .18</b>	<b>2208.00</b>	<b>CG309 .19</b>	<b>2208.00</b>	<b>CG309 .38</b>	<b>3018.00</b>
12M Plate	<b>CG312 .18</b>	<b>2809.00</b>	<b>CG312 .19</b>	<b>2809.00</b>	<b>CG312 .38</b>	<b>3839.00</b>
14M Plate	<b>CG314 .18</b>	<b>3492.00</b>	<b>CG314 .19</b>	<b>3492.00</b>	<b>CG314 .38</b>	<b>4376.00</b>
16M Plate	<b>CG316 .18</b>	<b>4966.00</b>	<b>CG316 .19</b>	<b>4966.00</b>	<b>CG316 .38</b>	<b>6786.00</b>
21M Plate	<b>CG321 .18</b>	<b>6437.00</b>	<b>CG321 .19</b>	<b>6437.00</b>	<b>CG321 .38</b>	<b>8797.00</b>



CM304 .10  
Solid Marble Finish Plate - 4 Module  
Sparkle White finish mounted with  
modules C5715 .01 and C5721 .01

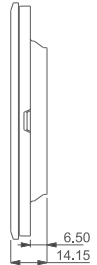

CM304 .11  
Solid Marble Finish Plate - 4 Module  
Terra Beige finish mounted with  
modules C5110 .01 and C5900 .01

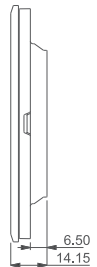

CM304 .12  
Solid Marble Finish Plate - 4 Module  
Salt White finish mounted with  
modules C5739 .02 and C5723 .02

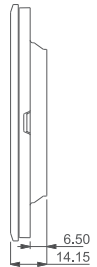

CM304 .13  
Solid Marble Finish Plate - 4 Module  
Onyx White finish mounted with  
modules C5110 .02 and C5721 .02

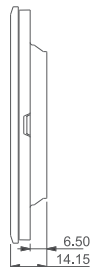

# CUBE Series

## Solid Marble Finish Plates with frames Sparkle White & Terra Beige

Description	Sparkle White		Terra Beige	
	Cat no.	Price	Cat no.	Price
1M Plate - for 75mm x 75mm box (3x3)	<b>CM301 .10</b>	<b>1156.00</b>	<b>CM301 .11</b>	<b>1156.00</b>
2M Plate - for 75mm x 75mm box (3x3)	<b>CM302 .10</b>	<b>1174.00</b>	<b>CM302 .11</b>	<b>1174.00</b>
3M Plate - for 100mm x 75mm box (4x3)	<b>CM303 .10</b>	<b>1244.00</b>	<b>CM303 .11</b>	<b>1244.00</b>
4M Plate - for 135mm x 75mm box (5x3)	<b>CM304 .10</b>	<b>1398.00</b>	<b>CM304 .11</b>	<b>1398.00</b>
6M Plate - for 210mm x 75mm box (8x3)	<b>CM306 .10</b>	<b>1530.00</b>	<b>CM306 .11</b>	<b>1530.00</b>
8M Plate - for 230/210 x 75mm box (9x3 or 8x3)	<b>CM308 .10</b>	<b>1658.00</b>	<b>CM308 .11</b>	<b>1658.00</b>
8M (V) Plate - for 135mm x 140mm box (5x5)	<b>CM309 .10</b>	<b>2041.00</b>	<b>CM309 .11</b>	<b>2041.00</b>
12M Plate - for 140mm x 210mm box (8x6)	<b>CM312 .10</b>	<b>2633.00</b>	<b>CM312 .11</b>	<b>2633.00</b>
14M Plate - for 140mm x 210mm box (8x6)	<b>CM314 .10</b>	<b>3298.00</b>	<b>CM314 .11</b>	<b>3298.00</b>
16M Plate - for 230x145mm box (10x6 or 9x6)	<b>CM316 .10</b>	<b>4490.00</b>	<b>CM316 .11</b>	<b>4490.00</b>
21M Plate - for 210mm x 210mm box (8x8)	<b>CM321 .10</b>	<b>5682.00</b>	<b>CM321 .11</b>	<b>5682.00</b>

79

## Solid Marble Finish Plates with frames Salt White & Onyx White

Description	Salt White		Onyx White	
	Cat no.	Price	Cat no.	Price
1M Plate - for 75mm x 75mm box (3x3)	<b>CM301 .12</b>	<b>1273.00</b>	<b>CM301 .13</b>	<b>1273.00</b>
2M Plate - for 75mm x 75mm box (3x3)	<b>CM302 .12</b>	<b>1292.00</b>	<b>CM302 .13</b>	<b>1292.00</b>
3M Plate - for 100mm x 75mm box (4x3)	<b>CM303 .12</b>	<b>1368.00</b>	<b>CM303 .13</b>	<b>1368.00</b>
4M Plate - for 135mm x 75mm box (5x3)	<b>CM304 .12</b>	<b>1537.00</b>	<b>CM304 .13</b>	<b>1537.00</b>
6M Plate - for 210mm x 75mm box (8x3)	<b>CM306 .12</b>	<b>1685.00</b>	<b>CM306 .13</b>	<b>1685.00</b>
8M Plate - for 230/210 x 75mm box (9x3 or 8x3)	<b>CM308 .12</b>	<b>1825.00</b>	<b>CM308 .13</b>	<b>1825.00</b>
8M (V) Plate - for 135mm x 140mm box (5x5)	<b>CM309 .12</b>	<b>2245.00</b>	<b>CM309 .13</b>	<b>2245.00</b>
12M Plate - for 140mm x 210mm box (8x6)	<b>CM312 .12</b>	<b>2897.00</b>	<b>CM312 .13</b>	<b>2897.00</b>
14M Plate - for 140mm x 210mm box (8x6)	<b>CM314 .12</b>	<b>3628.00</b>	<b>CM314 .13</b>	<b>3628.00</b>
16M Plate - for 230x145mm box (10x6 or 9x6)	<b>CM316 .12</b>	<b>4940.00</b>	<b>CM316 .13</b>	<b>4940.00</b>
21M Plate - for 210mm x 210mm box (8x8)	<b>CM321 .12</b>	<b>6251.00</b>	<b>CM321 .13</b>	<b>6251.00</b>

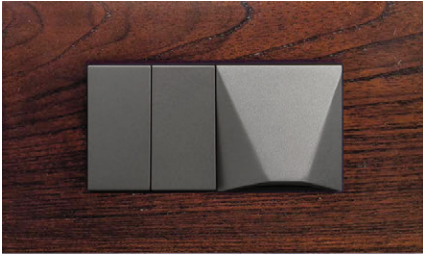

CW304 .06  
Solid Wood Plate - 4 Module  
dark mahogany mounted with  
modules C5110 .02 and C5721 .02

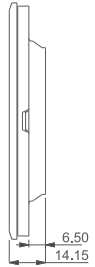

CW304 .07  
Solid Wood Plate - 4 Module  
natural pinewood mounted with  
modules C5110 .01 and C5900 .01

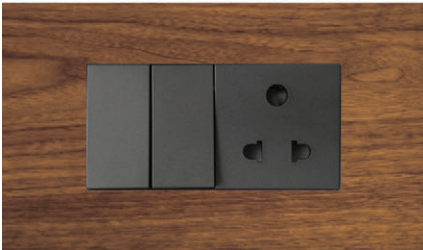
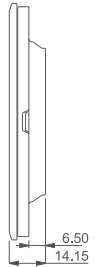

CW304 .29  
Solid Wood Plate - 4 Module  
walnut mounted with  
modules C5110 .02 and C5212 .02

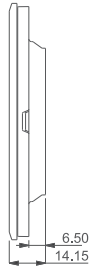

# CUBE Series

## Solid Wood Plates with frames Dark Mahogany & Natural Pinewood Polish

Description	Dark Mahogany		Pinewood	
	Cat no.	Price	Cat no.	Price
1M Plate - for 75mm x 75mm box (3x3)	<b>CW301 .06</b>	<b>1256.00</b>	<b>CW301 .07</b>	<b>1256.00</b>
2M Plate - for 75mm x 75mm box (3x3)	<b>CW302 .06</b>	<b>1275.00</b>	<b>CW302 .07</b>	<b>1275.00</b>
3M Plate - for 100mm x 75mm box (4x3)	<b>CW303 .06</b>	<b>1352.00</b>	<b>CW303 .07</b>	<b>1352.00</b>
4M Plate - for 135mm x 75mm box (5x3)	<b>CW304 .06</b>	<b>1520.00</b>	<b>CW304 .07</b>	<b>1520.00</b>
6M Plate - for 210mm x 75mm box (8x3)	<b>CW306 .06</b>	<b>1664.00</b>	<b>CW306 .07</b>	<b>1664.00</b>
8M Plate - for 230/210 x 75mm box (9x3 or 8x3)	<b>CW308 .06</b>	<b>1801.00</b>	<b>CW308 .07</b>	<b>1801.00</b>
8M (V) Plate - for 135mm x 140mm box (5x5)	<b>CW309 .06</b>	<b>2876.00</b>	<b>CW309 .07</b>	<b>2876.00</b>
12M Plate - for 140mm x 210mm box (8x6)	<b>CW312 .06</b>	<b>3923.00</b>	<b>CW312 .07</b>	<b>3923.00</b>
14M Plate - for 140mm x 210mm box (8x6)	<b>CW314 .06</b>	<b>4576.00</b>	<b>CW314 .07</b>	<b>4576.00</b>
16M Plate - for 230x145mm box (10x6 or 9x6)	<b>CW316 .06</b>	<b>6319.00</b>	<b>CW316 .07</b>	<b>6319.00</b>
21M Plate - for 210mm x 210mm box (8x8)	<b>CW321 .06</b>	<b>8062.00</b>	<b>CW321 .07</b>	<b>8062.00</b>

81

## Solid Wood Plates with frames Walnut Polish

Description	Walnut	
	Cat no.	Price
1M Plate - for 75mm x 75mm box (3x3)	<b>CW301 .29</b>	<b>1319.00</b>
2M Plate - for 75mm x 75mm box (3x3)	<b>CW302 .29</b>	<b>1339.00</b>
3M Plate - for 100mm x 75mm box (4x3)	<b>CW303 .29</b>	<b>1420.00</b>
4M Plate - for 135mm x 75mm box (5x3)	<b>CW304 .29</b>	<b>1595.00</b>
6M Plate - for 210mm x 75mm box (8x3)	<b>CW306 .29</b>	<b>1747.00</b>
8M Plate - for 230/210 x 75mm box (9x3 or 8x3)	<b>CW308 .29</b>	<b>1891.00</b>
8M (V) Plate - for 135mm x 140mm box (5x5)	<b>CW309 .29</b>	<b>3020.00</b>
12M Plate - for 140mm x 210mm box (8x6)	<b>CW312 .29</b>	<b>4119.00</b>
14M Plate - for 140mm x 210mm box (8x6)	<b>CW314 .29</b>	<b>4805.00</b>
16M Plate - for 230x145mm box (10x6 or 9x6)	<b>CW316 .29</b>	<b>6636.00</b>
21M Plate - for 210mm x 210mm box (8x8)	<b>CW321 .29</b>	<b>8465.00</b>



D5212 .01



D5532 .01



D5531 .01



D5332 .01  
D5732 .01



D5212 .02



D5532 .02



D5531 .02



D5332 .02  
D5732 .02



D5212 .17



D5532 .17



D5531 .17



D5332 .17  
D5732 .17

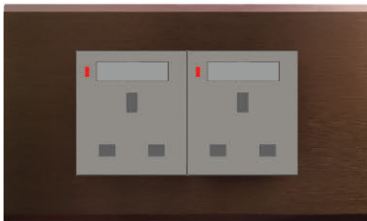

Integral Sockets can only be mounted on Special Flat'5 Plates suitable for mounting Integral Sockets. These plates are available in 2M & 4M sizes only. Colour options available in these plates are listed on the next page.



# CUBE Series

## Integral Sockets Frost White

Cat no.	Description	Price (Rs.)
<b>D5212 .01</b>	Integral Socket with Switch 6A 3+2 Pin [Round & Flat] Shuttered - 2M	<b>647.00</b>
<b>D5532 .01</b>	Integral Socket with Switch 13A International Multi Socket Shuttered - 2M	<b>818.00</b>
<b>D5531 .01</b>	Integral Socket with Switch 13A 3-Pin Flat Only Socket Shuttered - 2M	<b>802.00</b>
<b>D5332 .01</b>	Integral Socket with Switch 16A/6A 3-Pin Shuttered - 2 Module	<b>828.00</b>
<b>D5732 .01</b>	Integral Socket with Switch 25A/6A 3-Pin Shuttered - 2 Module	<b>1112.00</b>

## Integral Sockets Quartz Gray

Cat no.	Description	Price (Rs.)
<b>D5212 .02</b>	Integral Socket with Switch 6A 3+2 Pin [Round & Flat] Shuttered - 2M	<b>796.00</b>
<b>D5532 .02</b>	Integral Socket with Switch 13A International Multi Socket Shuttered - 2M	<b>1006.00</b>
<b>D5531 .02</b>	Integral Socket with Switch 13A 3-Pin Flat Only Socket Shuttered - 2M	<b>985.00</b>
<b>D5332 .02</b>	Integral Socket with Switch 16A/6A 3-Pin Shuttered - 2 Module	<b>1020.00</b>
<b>D5732 .02</b>	Integral Socket with Switch 25A/6A 3-Pin Shuttered - 2 Module	<b>1341.00</b>

83

## Integral Sockets Charcoal Black

Cat no.	Description	Price (Rs.)
<b>D5212 .17</b>	Integral Socket with Switch 6A 3+2 Pin [Round & Flat] Shuttered - 2M	<b>859.00</b>
<b>D5532 .17</b>	Integral Socket with Switch 13A International Multi Socket Shuttered - 2M	<b>1086.00</b>
<b>D5531 .17</b>	Integral Socket with Switch 13A 3-Pin Flat Only Socket Shuttered - 2M	<b>1064.00</b>
<b>D5332 .17</b>	Integral Socket with Switch 16A/6A 3-Pin Shuttered - 2 Module	<b>1101.00</b>
<b>D5732 .17</b>	Integral Socket with Switch 25A/6A 3-Pin Shuttered - 2 Module	<b>1475.00</b>

## Flat'5 Plates Suitable for Integral Sockets

<b>D6402 .01</b>	2M Plate - for 93mm x 95mm box (3x3) - Frost White	<b>275.00</b>
<b>D6404 .01</b>	4M Plate - for 93mm x 158mm box (3x5) - Frost White	<b>524.00</b>
<b>D6402 .02</b>	2M Plate - for 93mm x 95mm box (3x3) - Quartz Gray	<b>482.00</b>
<b>D6404 .02</b>	4M Plate - for 93mm x 158mm box (3x5) - Quartz Gray	<b>926.00</b>

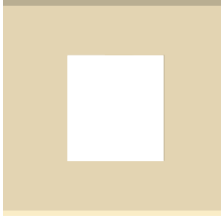

D6402 .01	DG302 .08
D6402 .02	DG302 .09
D6402 .03	DG302 .18
D6402 .16	DG302 .19
D6402 .17	DG302 .38
D6402 .25	DM302 .10
D6402 .26	DM302 .11
DA302 .04	DM302 .12
DA302 .05	DM302 .13
DA302 .14	DW302 .06

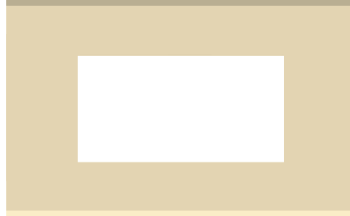

D6404 .01	DG304 .08
D6404 .02	DG304 .09
D6404 .03	DG304 .18
D6404 .16	DG304 .19
D6404 .17	DG304 .38
D6404 .25	DM304 .10
D6404 .26	DM304 .11
DA304 .04	DM304 .12
DA304 .05	DM304 .13
DA304 .14	DW304 .06

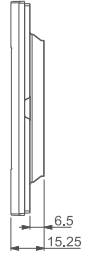

# CUBE Series

contd...

<b>D6402 .03</b>	2M Plate - for 93mm x 95mm box (3x3) - Ice Silver	<b>482.00</b>
<b>D6404 .03</b>	4M Plate - for 93mm x 158mm box (3x5) - Ice Silver	<b>926.00</b>
<b>D6402 .16</b>	2M Plate - for 93mm x 95mm box (3x3) - Matt Gold	<b>482.00</b>
<b>D6404 .16</b>	4M Plate - for 93mm x 158mm box (3x5) - Matt Gold	<b>926.00</b>
<b>D6402 .17</b>	2M Plate - for 93mm x 95mm box (3x3) - Charcoal Black	<b>482.00</b>
<b>D6404 .17</b>	4M Plate - for 93mm x 158mm box (3x5) - Charcoal Black	<b>926.00</b>
<b>D6402 .25</b>	2M Plate - for 93mm x 95mm box (3x3) - Cocoa Brown	<b>482.00</b>
<b>D6404 .25</b>	4M Plate - for 93mm x 158mm box (3x5) - Cocoa Brown	<b>926.00</b>
<b>D6402 .26</b>	2M Plate - for 93mm x 95mm box (3x3) - Silver Dust	<b>482.00</b>
<b>D6404 .26</b>	4M Plate - for 93mm x 158mm box (3x5) - Silver Dust	<b>926.00</b>
<b>DA302 .04</b>	2M Plate - for 93mm x 95mm box (3x3) - Solid Aluminum Natural	<b>1861.00</b>
<b>DA304 .04</b>	4M Plate - for 93mm x 158mm box (3x5) - Solid Aluminum Natural	<b>2290.00</b>
<b>DA302 .05</b>	2M Plate - for 93mm x 95mm box (3x3) - Solid Aluminum Black	<b>1861.00</b>
<b>DA304 .05</b>	4M Plate - for 93mm x 158mm box (3x5) - Solid Aluminum Black	<b>2290.00</b>
<b>DA302 .14</b>	2M Plate - for 93mm x 95mm box (3x3) - Solid Aluminum Dark Bronze	<b>1861.00</b>
<b>DA304 .14</b>	4M Plate - for 93mm x 158mm box (3x5) - Solid Aluminum Dark Bronze	<b>2290.00</b>
<b>DG302 .08</b>	2M Plate - for 93mm x 95mm box (3x3) - Solid Glass Ice White	<b>1298.00</b>
<b>DG304 .08</b>	4M Plate - for 93mm x 158mm box (3x5) - Solid Glass Ice White	<b>1598.00</b>
<b>DG302 .09</b>	2M Plate - for 93mm x 95mm box (3x3) - Solid Glass Metal Gray	<b>1298.00</b>
<b>DG304 .09</b>	4M Plate - for 93mm x 158mm box (3x5) - Solid Glass Metal Gray	<b>1598.00</b>
<b>DG302 .18</b>	2M Plate - for 93mm x 95mm box (3x3) - Solid Glass Smoked Silver	<b>1298.00</b>
<b>DG304 .18</b>	4M Plate - for 93mm x 158mm box (3x5) - Solid Glass Smoked Silver	<b>1598.00</b>
<b>DG302 .19</b>	2M Plate - for 93mm x 95mm box (3x3) - Solid Glass Solid Black	<b>1298.00</b>
<b>DG304 .19</b>	4M Plate - for 93mm x 158mm box (3x5) - Solid Glass Solid Black	<b>1598.00</b>
<b>DG302 .38</b>	2M Plate - for 93mm x 95mm box (3x3) - Solid Glass Ultra White	<b>1612.00</b>
<b>DG304 .38</b>	4M Plate - for 93mm x 158mm box (3x5) - Solid Glass Ultra White	<b>1984.00</b>
<b>DM302 .10</b>	2M Plate - for 93mm x 95mm box (3x3) - Marble Finish Sparkle White	<b>1244.00</b>
<b>DM304 .10</b>	4M Plate - for 93mm x 158mm box (3x5) - Marble Finish Sparkle White	<b>1529.00</b>
<b>DM302 .11</b>	2M Plate - for 93mm x 95mm box (3x3) - Marble Finish Terra Beige	<b>1244.00</b>
<b>DM304 .11</b>	4M Plate - for 93mm x 158mm box (3x5) - Marble Finish Terra Beige	<b>1529.00</b>
<b>DM302 .12</b>	2M Plate - for 93mm x 95mm box (3x3) - Marble Finish Salt White	<b>1244.00</b>
<b>DM304 .12</b>	4M Plate - for 93mm x 158mm box (3x5) - Marble Finish Salt White	<b>1529.00</b>
<b>DM302 .13</b>	2M Plate - for 93mm x 95mm box (3x3) - Marble Finish Onix White	<b>1244.00</b>
<b>DM304 .13</b>	4M Plate - for 93mm x 158mm box (3x5) - Marble Finish Onix White	<b>1529.00</b>
<b>DW302 .06</b>	2M Plate - for 93mm x 95mm box (3x3) - Solid Wood Dark Mahagony	<b>1353.00</b>
<b>DW304 .06</b>	4M Plate - for 93mm x 158mm box (3x5) - Solid Wood Dark Mahagony	<b>1664.00</b>



DW302 .07  
DW302 .29



DW304 .07  
DW304 .29

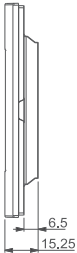

## CUBE Series

contd...

<b>DW302 .07</b>	2M Plate - for 93mm x 95mm box (3x3) - Solid Natural Pinewood	<b>1353.00</b>
<b>DW304 .07</b>	4M Plate - for 93mm x 158mm box (3x5) - Solid Natural Pinewood	<b>1664.00</b>
<b>DW302 .29</b>	2M Plate - for 93mm x 95mm box (3x3) - Solid Wood Walnut	<b>1421.00</b>
<b>DW304 .29</b>	4M Plate - for 93mm x 158mm box (3x5) - Solid Wood Walnut	<b>1747.00</b>

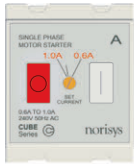

C525A .01

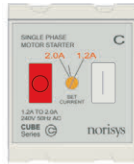

C525C .01

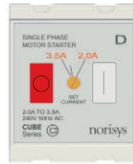

C525D .01

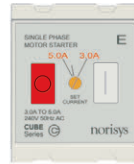

C525E .01

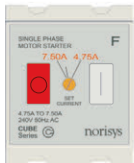
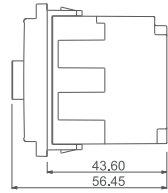

C525F .01

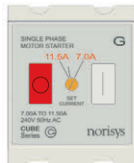

C525G .01



C525H .01



C525J .01

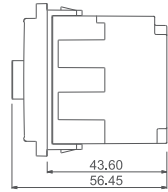

CTTSP06 .01



CTTSP10 .01



CTTSP16 .01



CTTSP20 .01



CTTSP25 .01



CTTSP32 .01

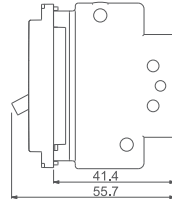

CTTDP06 .01  
CTTDP10 .01



CTTDP16 .01  
CTTDP20 .01



CTTDP25 .01  
CTTDP32 .01



CLBDP32 .01  
CLBDP50 .01

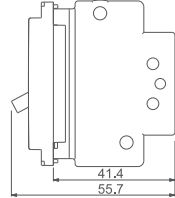

# CUBE Series

## Single Phase Motor Starters Frost White - for mounting with CUBE Series

Cat no.	Description	Price (Rs.)
<b>C525A .01</b>	Motor Starter 0.60 A - 1.00 A      1/8 HP Pump	<b>858.00</b>
<b>C525B .01</b>	Motor Starter 0.90 A - 1.50 A      1/4 HP Pump	<b>858.00</b>
<b>C525C .01</b>	Motor Starter 1.20 A - 2.00 A      1/3 HP Pump	<b>858.00</b>
<b>C525D .01</b>	Motor Starter 2.00 A - 3.50 A      1/2 HP Pump	<b>858.00</b>
<b>C525E .01</b>	Motor Starter 3.00 A - 5.00 A      3/4 HP Pump	<b>858.00</b>
<b>C525F .01</b>	Motor Starter 4.75 A - 7.50 A      1 Ton AC	<b>858.00</b>
<b>C525G .01</b>	Motor Starter 7.00 A - 11.50 A      1.5 Ton AC	<b>858.00</b>
<b>C525H .01</b>	Motor Starter 11.00 A - 18.00 A      2 Ton AC	<b>891.00</b>
<b>C525J .01</b>	Motor Starter 16.00 A - 25.00 A      2.5 Ton AC	<b>975.00</b>

## Tiny MCB Frost White - for mounting with CUBE Series

<b>CTTSP06 .01</b>	Tiny MCB Single Pole 6A	<b>398.00</b>
<b>CTTSP10 .01</b>	Tiny MCB Single Pole 10A	<b>398.00</b>
<b>CTTSP16 .01</b>	Tiny MCB Single Pole 16A	<b>398.00</b>
<b>CTTSP20 .01</b>	Tiny MCB Single Pole 20A	<b>398.00</b>
<b>CTTSP25 .01</b>	Tiny MCB Single Pole 25A	<b>398.00</b>
<b>CTTSP32 .01</b>	Tiny MCB Single Pole 32A	<b>398.00</b>
<b>CTTDP06 .01</b>	Tiny MCB Double Pole 6A	<b>993.00</b>
<b>CTTDP10 .01</b>	Tiny MCB Double Pole 10A	<b>993.00</b>
<b>CTTDP16 .01</b>	Tiny MCB Double Pole 16A	<b>993.00</b>
<b>CTTDP20 .01</b>	Tiny MCB Double Pole 20A	<b>993.00</b>
<b>CTTDP25 .01</b>	Tiny MCB Double Pole 25A	<b>993.00</b>
<b>CTTDP32 .01</b>	Tiny MCB Double Pole 32A	<b>993.00</b>

## Tiny Load Break Switch Frost White - for mounting with CUBE Series

<b>CLBDP32 .01</b>	Tiny Load Break Switch Double Pole 32A	<b>860.00</b>
<b>CLBDP50 .01</b>	Tiny Load Break Switch Double Pole 50A	<b>954.00</b>

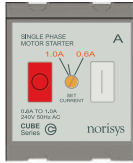

C525A .02

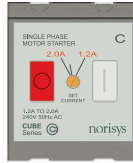

C525C .02

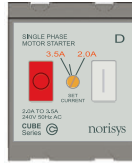

C525D .02

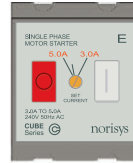

C525E .02

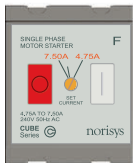
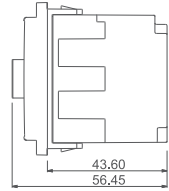

C525F .02



C525G .02

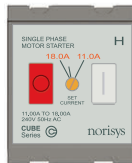

C525H .02

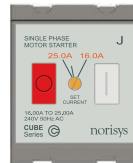

C525J .02

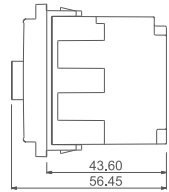

CTTSP06 .02



CTTSP10 .02



CTTSP16 .02



CTTSP20 .02



CTTSP25 .02



CTTSP32 .02

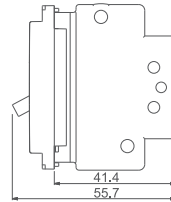

CTTDP06 .02  
CTTDP10 .02



CTTDP16 .02  
CTTDP20 .02



CTTDP25 .02  
CTTDP32 .02



CLBDP32 .02  
CLBDP50 .02

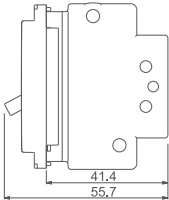



# CUBE Series

## Single Phase Motor Starters Quartz Gray - for mounting with CUBE Series

Cat no.	Description	Price (Rs.)
<b>C525A .02</b>	Motor Starter 0.60 A - 1.00 A      1/8 HP Pump	<b>1065.00</b>
<b>C525B .02</b>	Motor Starter 0.90 A - 1.50 A      1/4 HP Pump	<b>1065.00</b>
<b>C525C .02</b>	Motor Starter 1.20 A - 2.00 A      1/3 HP Pump	<b>1065.00</b>
<b>C525D .02</b>	Motor Starter 2.00 A - 3.50 A      1/2 HP Pump	<b>1065.00</b>
<b>C525E .02</b>	Motor Starter 3.00 A - 5.00 A      3/4 HP Pump	<b>1065.00</b>
<b>C525F .02</b>	Motor Starter 4.75 A - 7.50 A      1 Ton AC	<b>1065.00</b>
<b>C525G .02</b>	Motor Starter 7.00 A - 11.50 A      1.5 Ton AC	<b>1065.00</b>
<b>C525H .02</b>	Motor Starter 11.00 A - 18.00 A      2 Ton AC	<b>1106.00</b>
<b>C525J .02</b>	Motor Starter 16.00 A - 25.00 A      2.5 Ton AC	<b>1208.00</b>

## Tiny MCB Quartz Gray - for mounting with CUBE Series

<b>CTTSP06 .02</b>	Tiny MCB Single Pole 6A	<b>482.00</b>
<b>CTTSP10 .02</b>	Tiny MCB Single Pole 10A	<b>482.00</b>
<b>CTTSP16 .02</b>	Tiny MCB Single Pole 16A	<b>482.00</b>
<b>CTTSP20 .02</b>	Tiny MCB Single Pole 20A	<b>482.00</b>
<b>CTTSP25 .02</b>	Tiny MCB Single Pole 25A	<b>482.00</b>
<b>CTTSP32 .02</b>	Tiny MCB Single Pole 32A	<b>482.00</b>
<b>CTTDP06 .02</b>	Tiny MCB Double Pole 6A	<b>1212.00</b>
<b>CTTDP10 .02</b>	Tiny MCB Double Pole 10A	<b>1212.00</b>
<b>CTTDP16 .02</b>	Tiny MCB Double Pole 16A	<b>1212.00</b>
<b>CTTDP20 .02</b>	Tiny MCB Double Pole 20A	<b>1212.00</b>
<b>CTTDP25 .02</b>	Tiny MCB Double Pole 25A	<b>1212.00</b>
<b>CTTDP32 .02</b>	Tiny MCB Double Pole 32A	<b>1212.00</b>

## Tiny Load Break Switch Quartz Gray - for mounting with CUBE Series

<b>CLBDP32 .02</b>	Tiny Load Break Switch Double Pole 32A	<b>1068.00</b>
<b>CLBDP50 .02</b>	Tiny Load Break Switch Double Pole 50A	<b>1183.00</b>



C525A .17

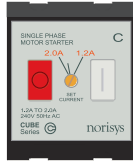

C525C .17

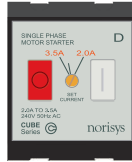

C525D .17

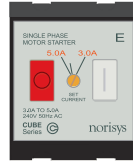

C525E .17

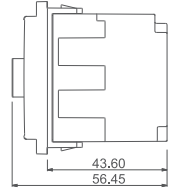

C525F .17



C525G .17



C525H .17

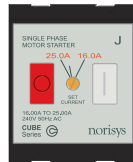

C525J .17

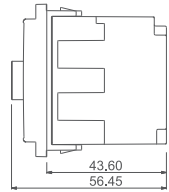

CTTSP06 .17



CTTSP10 .17



CTTSP16 .17



CTTSP20 .17



CTTSP25 .17



CTTSP32 .17

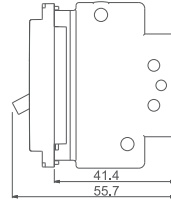

CTTDP06.17  
CTTDP10.17



CTTDP16.17  
CTTDP20.17



CTTDP25.17  
CTTDP32.17

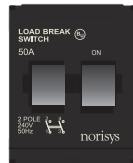

CLBDP32.17  
CLBDP50.17

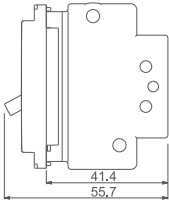

# CUBE Series

## Single Phase Motor Starters Charcoal Black - for mounting with CUBE Series

Cat no.	Description	Price (Rs.)
<b>C525A .17</b>	Motor Starter 0.60 A - 1.00 A      1/8 HP Pump	<b>1161.00</b>
<b>C525B .17</b>	Motor Starter 0.90 A - 1.50 A      1/4 HP Pump	<b>1161.00</b>
<b>C525C .17</b>	Motor Starter 1.20 A - 2.00 A      1/3 HP Pump	<b>1161.00</b>
<b>C525D .17</b>	Motor Starter 2.00 A - 3.50 A      1/2 HP Pump	<b>1161.00</b>
<b>C525E .17</b>	Motor Starter 3.00 A - 5.00 A      3/4 HP Pump	<b>1161.00</b>
<b>C525F .17</b>	Motor Starter 4.75 A - 7.50 A      1 Ton AC	<b>1161.00</b>
<b>C525G .17</b>	Motor Starter 7.00 A - 11.50 A      1.5 Ton AC	<b>1161.00</b>
<b>C525H .17</b>	Motor Starter 11.00 A - 18.00 A      2 Ton AC	<b>1206.00</b>
<b>C525J .17</b>	Motor Starter 16.00 A - 25.00 A      2.5 Ton AC	<b>1318.00</b>

## Tiny MCB Charcoal Black - for mounting with CUBE Series

<b>CTTSP06 .17</b>	Tiny MCB Single Pole 6A	<b>529.00</b>
<b>CTTSP10 .17</b>	Tiny MCB Single Pole 10A	<b>529.00</b>
<b>CTTSP16 .17</b>	Tiny MCB Single Pole 16A	<b>529.00</b>
<b>CTTSP20 .17</b>	Tiny MCB Single Pole 20A	<b>529.00</b>
<b>CTTSP25 .17</b>	Tiny MCB Single Pole 25A	<b>529.00</b>
<b>CTTSP32 .17</b>	Tiny MCB Single Pole 32A	<b>529.00</b>
<b>CTTDP06 .17</b>	Tiny MCB Double Pole 6A	<b>1321.00</b>
<b>CTTDP10 .17</b>	Tiny MCB Double Pole 10A	<b>1321.00</b>
<b>CTTDP16 .17</b>	Tiny MCB Double Pole 16A	<b>1321.00</b>
<b>CTTDP20 .17</b>	Tiny MCB Double Pole 20A	<b>1321.00</b>
<b>CTTDP25 .17</b>	Tiny MCB Double Pole 25A	<b>1321.00</b>
<b>CTTDP32 .17</b>	Tiny MCB Double Pole 32A	<b>1321.00</b>

## Tiny Load Break Switch Charcoal Black - for mounting with CUBE Series

<b>CLBDP32 .17</b>	Tiny Load Break Switch Double Pole 32A	<b>1164.00</b>
<b>CLBDP50 .17</b>	Tiny Load Break Switch Double Pole 50A	<b>1290.00</b>



S7110 .01  
S7130 .01



S7210 .01  
S7230 .01



S7111 .01  
S7131 .01  
S7731 .01



S7211 .01  
S7231 .01



S7310 .01



S7311 .01

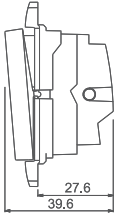

S7340 .01



S7341 .01



S7180 .01



S7191 .01  
S7171 .01

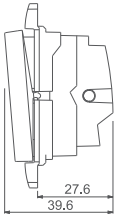

S8110 .01



S8210 .01



S8130 .01  
S8730 .01



S8230 .01



S8310 .01



S8311 .01

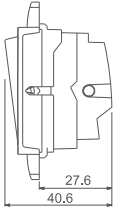

S8111 .01



S8211 .01



S8131 .01  
S8731 .01



S8231 .01

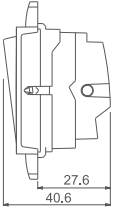

# SQUARE Series

## Switches Frost White

Cat no.	Description	Price (Rs.)
<b>S7110 .01</b>	Switch 6A One-way (Collarless Style) - 1 Module	<b>104.00</b>
<b>S7111 .01</b>	Switch 6A One-way with indicator (Collarless Style) - 1 Module	<b>212.00</b>
<b>S7210 .01</b>	Switch 6A Two-way (Collarless Style) - 1 Module	<b>191.00</b>
<b>S7211 .01</b>	Switch 6A Two-way with indicator (Collarless Style) - 1 Module	<b>275.00</b>
<b>S7130 .01</b>	Switch 16A One-way (Collarless Style) - 1 Module	<b>227.00</b>
<b>S7131 .01</b>	Switch 16A One-way with indicator (Collarless Style) - 1 Module	<b>265.00</b>
<b>S7230 .01</b>	Switch 16A Two-way (Collarless Style) - 1 Module	<b>244.00</b>
<b>S7231 .01</b>	Switch 16A Two-way with indicator (Collarless Style) - 1 Module	<b>317.00</b>
<b>S7731 .01</b>	Switch 25A One-way with indicator (Collarless Style) - 1 Module	<b>383.00</b>
<b>S7310 .01</b>	Switch 6A - Bell (Collarless Style) - 1 Module	<b>197.00</b>
<b>S7311 .01</b>	Switch 6A - Bell with indicator (Collarless Style) - 1 Module	<b>250.00</b>
<b>S7340 .01</b>	Palm Bell Switch 6A (Collarless Style) - 2 Module	<b>251.00</b>
<b>S7341 .01</b>	Palm Bell Switch 6A with indicator (Collarless Style) - 2 Module	<b>282.00</b>
<b>S7180 .01</b>	Palm Switch 6A One-way Double Pole (Collarless Style) - 2 Module	<b>340.00</b>
<b>S7280 .01</b>	Palm Switch 6A Two-way Double Pole (Collarless Style) - 2 Module	<b>369.00</b>
<b>S7191 .01</b>	Palm Switch 16A One-way DP with indicator (Collarless) - 2 Module	<b>480.00</b>
<b>S7291 .01</b>	Palm Switch 16A Two-way DP with indicator (Collarless) - 2 Module	<b>566.00</b>
<b>S7171 .01</b>	Palm Switch 25A One-way DP with indicator (Collarless) - 2 Module	<b>571.00</b>
<b>S8110 .01</b>	Switch 6A One-way (Collar Style) - 1 Module	<b>91.00</b>
<b>S8111 .01</b>	Switch 6A One-way with indicator (Collar Style) - 1 Module	<b>201.00</b>
<b>S8210 .01</b>	Switch 6A Two-way (Collar Style) - 1 Module	<b>188.00</b>
<b>S8211 .01</b>	Switch 6A Two-way with indicator (Collar Style) - 1 Module	<b>255.00</b>
<b>S8130 .01</b>	Switch 16A One-way (Collar Style) - 1 Module	<b>229.00</b>
<b>S8131 .01</b>	Switch 16A One-way with indicator (Collar Style) - 1 Module	<b>254.00</b>
<b>S8230 .01</b>	Switch 16A Two-way (Collar Style) - 1 Module	<b>246.00</b>
<b>S8231 .01</b>	Switch 16A Two-way with indicator (Collar Style) - 1 Module	<b>343.00</b>
<b>S8730 .01</b>	Switch 25A One-way (Collar Style) - 1 Module	<b>298.00</b>
<b>S8731 .01</b>	Switch 25A One-way with indicator (Collar Style) - 1 Module	<b>356.00</b>
<b>S8310 .01</b>	Switch 6A - Bell (Collar Style) - 1 Module	<b>188.00</b>
<b>S8311 .01</b>	Switch 6A - Bell with indicator (Collar Style) - 1 Module	<b>236.00</b>



S7213 .01



S7332 .01  
S7732 .01



S7412 .01



S7532 .01  
S7531 .01

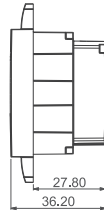

S1010 .01

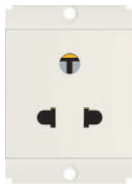

S7212 .01

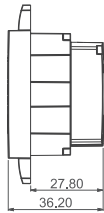

S7900 .01  
S7910 .01  
S7912 .01



S7901 .01  
S7911 .01



S7913 .01



S7904 .01

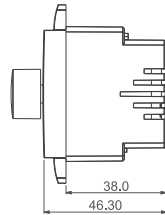

S7902 .01  
S7903 .01



S7905 .01  
S7908 .01

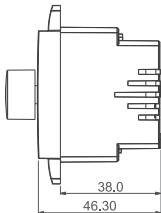

# SQUARE Series

## Sockets Frost White

Cat no.	Description	Price (Rs.)
<b>S7213 .01</b>	Socket 6A 3-Pin-only Shuttered - 2 Module (As per Indian Standard)	<b>251.00</b>
<b>S7332 .01</b>	Socket 16A/6A 3-Pin Shuttered - 2 Module (As per Indian Standard)	<b>356.00</b>
<b>S7212 .01</b>	Socket 6A 3+2 Pin [Round & Flat] Shuttered - 2 Module *	<b>268.00</b>
<b>S7412 .01</b>	Socket 6A 3+2 Pin And 2 pin Shuttered - 2 Module *	<b>378.00</b>
<b>S1010 .01</b>	Socket 6A 2 Pin [Round & Flat] - 1 Module *	<b>179.00</b>
<b>S7532 .01</b>	Socket 13A International Multi-Socket Shuttered - 2 Module *	<b>356.00</b>
<b>S7531 .01</b>	Socket 13A 3-Pin Flat Socket Shuttered - 2 Module *	<b>345.00</b>
<b>S7732 .01</b>	Socket 25A/6A 3-Pin Shuttered - 2 Module *	<b>404.00</b>

## Fan Regulators & Dimmers Frost White

<b>S7900 .01</b>	Fan Regulator Step Type with Bar Knob for 80W fan - 2 Module	<b>959.00</b>
<b>S7901 .01</b>	Fan Regulator Step Type with Round Knob for 80W fan - 2 Module	<b>912.00</b>
<b>S7910 .01</b>	Fan Regulator Step Type with Bar Knob for 120W fan - 2 Module	<b>1054.00</b>
<b>S7911 .01</b>	Fan Regulator Step Type with Round Knob for 120W fan - 2 Module	<b>1004.00</b>
<b>S7912 .01</b>	Fan Regulator 8-Step Type with Bar Knob for 120W fan - 2 Module	<b>1096.00</b>
<b>S7913 .01</b>	Fan Regulator 8-Step Type with Round Knob for 120W fan - 2 Module	<b>1046.00</b>
<b>S7902 .01</b>	Dimmer 500 Watts - 2 Module	<b>758.00</b>
<b>S7903 .01</b>	Dimmer 1000 Watts - 2 Module	<b>1040.00</b>
<b>S7904 .01</b>	Fan Regulator Single Module for 80W Fan - Step Type - 1 Module	<b>534.00</b>
<b>S7905 .01</b>	Dimmer 500 Watts - 1 Module	<b>569.00</b>
<b>S7908 .01</b>	Dimmer for LED Lights (3 wire system) - 1 Module	<b>566.00</b>

97

\* Only for export outside India



S7797 .01



S7800 .01  
S7101 .01



S7820 .01



S7600 .01



S7802 .01  
S7100 .01



S7725 .01  
S7736 .01

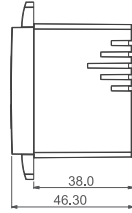

S7836 .01



S7936 .01



S7937 .01



S7729 .01

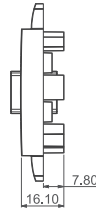



# SQUARE Series

## Communique' Frost White

Cat no.	Description	Price (Rs.)
<b>S7797 .01</b>	Coaxial T.V Socket - 1 Module	<b>187.00</b>
<b>S7800 .01</b>	Telephone Socket RJ-11 Double Line Shuttered - 1 Module	<b>194.00</b>
<b>S7820 .01</b>	Twin Telephone Socket RJ-11 - 1 Module	<b>257.00</b>
<b>S7802 .01</b>	Information Socket 6e - UTP Shuttered - 1 Module	<b>655.00</b>
<b>S7100 .01</b>	Information Socket 6a - UTP Shuttered - 1 Module	<b>1126.00</b>
<b>S7725 .01</b>	USB Extension Socket - 1 Module	<b>516.00</b>
<b>S7736 .01</b>	USB Charger Socket Outlet A Type- 2.1 Amps - 1 Module	<b>2289.00</b>
<b>S7836 .01</b>	USB Charger Socket Outlet C Type - 2.1 Amps - 1 Module	<b>2531.00</b>
<b>S7936 .01</b>	USB Charger Socket Outlet A+C Type - 2.1 Amps - 1 Module	<b>2759.00</b>
<b>S7937 .01</b>	USB Charger Socket Outlet C+C Type - 3.1 Amps - 1 Module	<b>3148.00</b>
<b>S7729 .01</b>	Computer Monitor Output Socket - 1 Module	<b>335.00</b>
<b>S7101 .01</b>	Fitment for RJ-45 Computer Socket Shuttered - 1 Module	<b>208.00</b>
<b>S7600 .01</b>	Indicator Light - 1 Module	<b>119.00</b>



S7232 .01



S7233 .01



S8232 .01



S8233 .01



S7262 .01

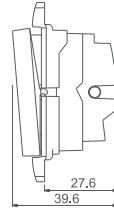

S7711 .01



S7450 .01



S7460 .01



S7500 .01

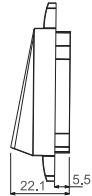

S7706 .01  
S7707 .01  
S7709 .01



S7721 .01



S7700 .01



S7798 .01

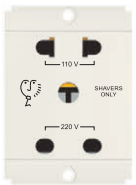
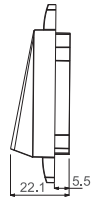

S7723 .01

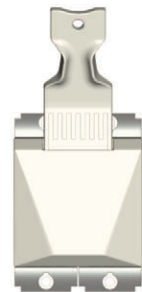

S7719 .01



S7720 .01

# SQUARE Series

## Hospitality Modules Frost White

Cat no.	Description	Price (Rs.)
<b>S7232 .01</b>	"Do Not Disturb" Switch with indicator (Collarless Style) - 1 Module	<b>363.00</b>
<b>S7233 .01</b>	"Clean My Room" Switch with indicator (Collarless Style) - 1 Module	<b>363.00</b>
<b>S8232 .01</b>	"Do Not Disturb" Switch with indicator (Collar Style) - 1 Module	<b>348.00</b>
<b>S8233 .01</b>	"Clean My Room" Switch with indicator (Collar Style) - 1 Module	<b>348.00</b>
<b>S7262 .01</b>	Bell Switch with "Do Not Disturb" and "Clean My Room" indicator - 2M	<b>588.00</b>
<b>S7711 .01</b>	Call Bell Station with Register and Provision for External Buzzer - 2M	<b>1391.00</b>
<b>S7719 .01</b>	25A Key Fob Switch Double Pole with indicator - 2 Module	<b>1132.00</b>
<b>S7720 .01</b>	Key Fob - customized	<b>201.00</b>
<b>S7723 .01</b>	Shaver Socket 220V / 110V with transformer - 2 module	<b>940.00</b>
<b>S7450 .01</b>	Push Button Station Start - Stop (Collorless Style) - 2 Module	<b>505.00</b>
<b>S7460 .01</b>	Push Button Station Open - Close (Collorless Style) - 2 Module	<b>562.00</b>

101

## Acoustic and Optical Signaling Frost White

<b>S7706 .01</b>	Speaker for audio music circuit - 2 Module	<b>1134.00</b>
<b>S7707 .01</b>	Electronic Bell - 2 Module	<b>642.00</b>
<b>S7709 .01</b>	Electronic Buzzer - 2 Module	<b>575.00</b>
<b>S7721 .01</b>	Step Marker Lamp / Night Lamp - 2 Module	<b>593.00</b>
<b>S7798 .01</b>	Audio Port / Jack 3.5mm - 1 Module	<b>392.00</b>

## Support Modules Frost White

<b>S7500 .01</b>	Cord Outlet - 1 Module	<b>128.00</b>
<b>S7700 .01</b>	Blanking Plate - 1 Module	<b>45.00</b>



S7110 .23



S7210 .23



S7111 .23



S7211 .23



S7310 .23



S7311 .23

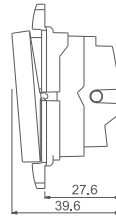

S7130 .23



S7230 .23



S7131 .23



S7731 .23



S7231 .23

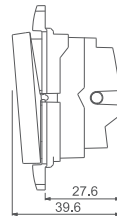

S7340 .23

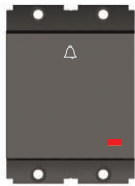

S7341 .23



S7180 .23



S7191 .23

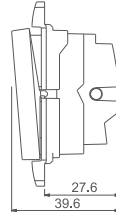

S7171 .23

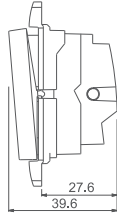

# SQUARE Series

## Switches Graphite Gray

Cat no.	Description	Price (Rs.)
<b>S7110 .23</b>	Switch 6A One-way (Collarless Style) - 1 Module	<b>126.00</b>
<b>S7111 .23</b>	Switch 6A One-way with indicator (Collarless Style) - 1 Module	<b>264.00</b>
<b>S7210 .23</b>	Switch 6A Two-way (Collarless Style) - 1 Module	<b>235.00</b>
<b>S7211 .23</b>	Switch 6A Two-way with indicator (Collarless Style) - 1 Module	<b>339.00</b>
<b>S7130 .23</b>	Switch 16A One-way (Collarless Style) - 1 Module	<b>281.00</b>
<b>S7131 .23</b>	Switch 16A One-way with indicator (Collarless Style) - 1 Module	<b>328.00</b>
<b>S7230 .23</b>	Switch 16A Two-way (Collarless Style) - 1 Module	<b>302.00</b>
<b>S7231 .23</b>	Switch 16A Two-way with indicator (Collarless Style) - 1 Module	<b>392.00</b>
<b>S7731 .23</b>	Switch 25A One-way with indicator (Collarless Style) - 1 Module	<b>473.00</b>
<b>S7310 .23</b>	Switch 6A - Bell (Collarless Style) - 1 Module	<b>243.00</b>
<b>S7311 .23</b>	Switch 6A - Bell with indicator (Collarless Style) - 1 Module	<b>309.00</b>
<b>S7340 .23</b>	Palm Bell Switch 6A (Collarless Style) - 2 Module	<b>302.00</b>
<b>S7341 .23</b>	Palm Bell Switch 6A with indicator (Collarless Style) - 2 Module	<b>339.00</b>
<b>S7180 .23</b>	Palm Switch 6A One-way Double Pole (Collarless Style) - 2 Module	<b>410.00</b>
<b>S7280 .23</b>	Palm Switch 6A Two-way Double Pole (Collarless Style) - 2 Module	<b>440.00</b>
<b>S7191 .23</b>	Palm Switch 16A One-way DP with indicator (Collarless) - 2 Module	<b>578.00</b>
<b>S7291 .23</b>	Palm Switch 16A Two-way DP with indicator (Collarless) - 2 Module	<b>679.00</b>
<b>S7171 .23</b>	Palm Switch 25A One-way DP with indicator (Collarless) - 2 Module	<b>686.00</b>



S7213 .23



S7332 .23  
S7732 .23



S7412 .23

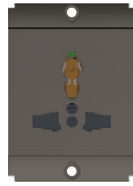

S7532 .23  
S7531 .23

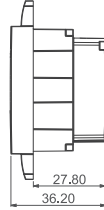

S1010 .23



S7212 .23

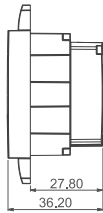

S7900 .23  
S7910 .23  
S7912 .23



S7901 .23  
S7911 .23



S7913 .23



S7904 .23

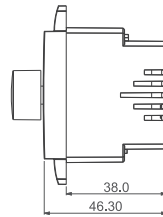

S7902 .23  
S7903 .23



S7905 .23  
S7908 .23

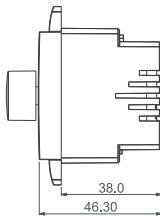

# SQUARE Series

## Sockets Graphite Gray

Cat no.	Description	Price (Rs.)
<b>S7213 .23</b>	Socket 6A 3-Pin-only Shuttered - 2 Module (As per Indian Standard)	<b>303.00</b>
<b>S7332 .23</b>	Socket 16A/6A 3-Pin Shuttered - 2 Module (As per Indian Standard)	<b>433.00</b>
<b>S7212 .23</b>	Socket 6A 3+2 Pin [Round & Flat] Shuttered - 2 Module *	<b>321.00</b>
<b>S7412 .23</b>	Socket 6A 3+2 Pin And 2 pin Shuttered - 2 Module *	<b>454.00</b>
<b>S1010 .23</b>	Socket 6A 2 Pin [Round & Flat] - 1 Module *	<b>214.00</b>
<b>S7532 .23</b>	Socket 13A International Multi-Socket Shuttered - 2 Module *	<b>433.00</b>
<b>S7531 .23</b>	Socket 13A 3-Pin Flat Socket Shuttered - 2 Module *	<b>416.00</b>
<b>S7732 .23</b>	Socket 25A/6A 3-Pin Shuttered - 2 Module *	<b>486.00</b>

## Fan Regulators & Dimmers Graphite Gray

<b>S7900 .23</b>	Fan Regulator Step Type with Bar Knob for 80W fan - 2 Module	<b>1151.00</b>
<b>S7901 .23</b>	Fan Regulator Step Type with Round Knob for 80W fan - 2 Module	<b>1096.00</b>
<b>S7910 .23</b>	Fan Regulator Step Type with Bar Knob for 120W fan - 2 Module	<b>1266.00</b>
<b>S7911 .23</b>	Fan Regulator Step Type with Round Knob for 120W fan - 2 Module	<b>1205.00</b>
<b>S7912 .23</b>	Fan Regulator 8-Step Type with Bar Knob for 120W fan - 2 Module	<b>1317.00</b>
<b>S7913 .23</b>	Fan Regulator 8-Step Type with Round Knob for 120W fan - 2 Module	<b>1256.00</b>
<b>S7902 .23</b>	Dimmer 500 Watts - 2 Module	<b>910.00</b>
<b>S7903 .23</b>	Dimmer 1000 Watts - 2 Module	<b>1248.00</b>
<b>S7904 .23</b>	Fan Regulator Single Module for 80W Fan - Step Type - 1 Module	<b>643.00</b>
<b>S7905 .23</b>	Dimmer 500 Watts - 1 Module	<b>685.00</b>
<b>S7908 .23</b>	Dimmer for LED Lights (3 wire system) - 1 Module	<b>679.00</b>

\* Only for export outside India



S7797 .23



S7800 .23  
S7101 .23



S7820 .23



S7600 .23



S7802 .23  
S7100 .23



S7725 .23  
S7736 .23



S7836 .23



S7936 .23



S7937 .23



S7729 .23

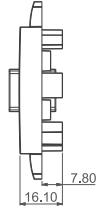



# SQUARE Series

## Communique' Graphite Gray

Cat no.	Description	Price (Rs.)
<b>S7797 .23</b>	Coaxial T.V Socket - 1 Module	<b>225.00</b>
<b>S7800 .23</b>	Telephone Socket RJ-11 Double Line Shuttered - 1 Module	<b>233.00</b>
<b>S7820 .23</b>	Twin Telephone Socket RJ-11 - 1 Module	<b>309.00</b>
<b>S7802 .23</b>	Information Socket 6e - UTP Shuttered - 1 Module	<b>788.00</b>
<b>S7100 .23</b>	Information Socket 6a - UTP Shuttered - 1 Module	<b>1362.00</b>
<b>S7725 .23</b>	USB Extension Socket - 1 Module	<b>618.00</b>
<b>S7736 .23</b>	USB Charger Socket Outlet A Type - 2.1 Amps - 1 Module	<b>2722.00</b>
<b>S7836 .23</b>	USB Charger Socket Outlet C Type - 2.1 Amps - 1 Module	<b>3008.00</b>
<b>S7936 .23</b>	USB Charger Socket Outlet A+C Type - 2.1 Amps - 1 Module	<b>3280.00</b>
<b>S7937 .23</b>	USB Charger Socket Outlet C+C Type - 3.1 Amps - 1 Module	<b>3746.00</b>
<b>S7729 .23</b>	Computer Monitor Output Socket - 1 Module	<b>402.00</b>
<b>S7101 .23</b>	Fitment for RJ-45 Computer Socket Shuttered - 1 Module	<b>250.00</b>
<b>S7600 .23</b>	Indicator Light - 1 Module	<b>143.00</b>



S7232 .23



S7233 .23



S7706 .23



S7262 .23

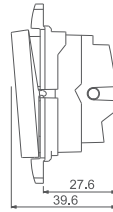

S7711 .23



S7450 .23



S7460 .23



S7500 .23

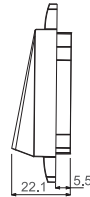

S7707 .23  
S7709 .23



S7721 .23



S7700 .23



S7798 .23

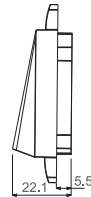

S7723 .23



S7719 .23



S7720 .23

# SQUARE Series

## Hospitality Modules Graphite Gray

Cat no.	Description	Price (Rs.)
<b>S7232 .23</b>	"Do Not Disturb" Switch with indicator (Collarless Style) - 1 Module	<b>436.00</b>
<b>S7233 .23</b>	"Clean My Room" Switch with indicator (Collarless Style) - 1 Module	<b>436.00</b>
<b>S7262 .23</b>	Bell Switch with "Do Not Disturb" and "Clean My Room" indicator - 2M	<b>707.00</b>
<b>S7711 .23</b>	Call Bell Station with Register and Provision for External Buzzer - 2M	<b>1670.00</b>
<b>S7719 .23</b>	25A Key Fob Switch Double Pole with indicator - 2 Module	<b>1359.00</b>
<b>S7720 .23</b>	Key Fob - customized	<b>240.00</b>
<b>S7723 .23</b>	Shaver Socket 220V / 110V with transformer - 2 module	<b>1128.00</b>
<b>S7450 .23</b>	Push Button Station Start - Stop (Collarless Style) - 2 module	<b>606.00</b>
<b>S7460 .23</b>	Push Button Station Open - Close (Collarless Style) - 2 module	<b>675.00</b>

## Acoustic and Optical Signaling Graphite Gray

<b>S7706 .23</b>	Speaker for audio music circuit - 2 Module	<b>1360.00</b>
<b>S7707 .23</b>	Electronic Bell - 2 Module	<b>772.00</b>
<b>S7709 .23</b>	Electronic Buzzer - 2 Module	<b>691.00</b>
<b>S7721 .23</b>	Step Marker Lamp / Night Lamp - 2 Module	<b>712.00</b>
<b>S7798 .23</b>	Audio Port / Jack 3.5mm - 1 Module	<b>471.00</b>

109

## Support Modules Graphite Gray

<b>S7500 .23</b>	Cord Outlet - 1 Module	<b>153.00</b>
<b>S7700 .23</b>	Blanking Plate - 1 Module	<b>51.00</b>



S7601 .01 S7601 .25  
 S7601 .03 S7601 .27  
 S7601 .23

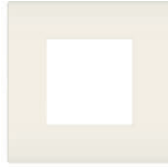

S7602 .01 S7602 .25  
 S7602 .03 S7602 .27  
 S7602 .23



S7633 .01 S7633 .25  
 S7633 .03 S7633 .27  
 S7633 .23

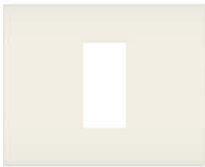
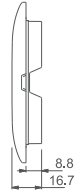

S7631 .01 S7631 .25  
 S7631 .03 S7631 .27  
 S7631 .23



S7632 .01 S7632 .25  
 S7632 .03 S7632 .27  
 S7632 .23



S7604 .01 S7604 .25  
 S7604 .03 S7604 .27  
 S7604 .23

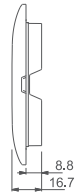

S7606 .01 S7606 .25  
 S7606 .03 S7606 .27  
 S7606 .23



S7608 .01 S7608 .25  
 S7608 .03 S7608 .27  
 S7608 .23

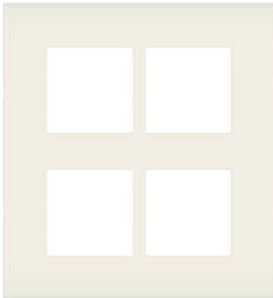

S7609 .01 S7609 .25  
 S7609 .03 S7609 .27  
 S7609 .23

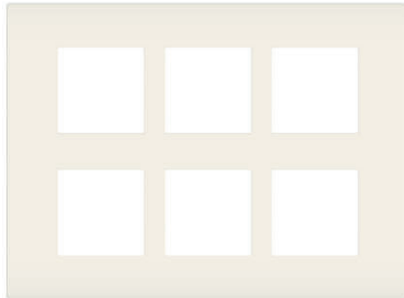

S7612 .01 S7612 .25  
 S7612 .03 S7612 .27  
 S7612 .23

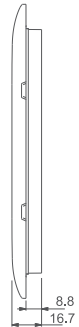

# SQUARE Series

## Smart Plates with frames Frost White and Wood Finish

Description	Frost White		Wood Finish	
	Cat no.	Price (Rs.)	Cat no.	Price (Rs.)
1M Plate - for 75mm x 75mm box (3x3)	<b>S7601</b>	<b>.01 145.00</b>	<b>S7601</b>	<b>.27 474.00</b>
2M Plate - for 75mm x 75mm box (3x3)	<b>S7602</b>	<b>.01 145.00</b>	<b>S7602</b>	<b>.27 474.00</b>
3M Plate - for 100mm x 75mm box (4x3)	<b>S7633</b>	<b>.01 164.00</b>	<b>S7633</b>	<b>.27 536.00</b>
1M Plate - for 100mm x 75mm box (4x3)	<b>S7631</b>	<b>.01 164.00</b>	<b>S7631</b>	<b>.27 536.00</b>
2M Plate - for 100mm x 75mm box (4x3)	<b>S7632</b>	<b>.01 164.00</b>	<b>S7632</b>	<b>.27 536.00</b>
4M Plate - for 135mm x 75mm box (5x3)	<b>S7604</b>	<b>.01 180.00</b>	<b>S7604</b>	<b>.27 589.00</b>
6M Plate - for 210mm x 75mm box (8x3)	<b>S7606</b>	<b>.01 300.00</b>	<b>S7606</b>	<b>.27 985.00</b>
8M Plate - for 230mm x 75mm box (9x3)	<b>S7608</b>	<b>.01 357.00</b>	<b>S7608</b>	<b>.27 1171.00</b>
8M(V) Plate - for 135mm x 140mm box (5x5)	<b>S7609</b>	<b>.01 418.00</b>	<b>S7609</b>	<b>.27 1372.00</b>
12M Plate - for 140mm x 210mm box (8x6)	<b>S7612</b>	<b>.01 495.00</b>	<b>S7612</b>	<b>.27 1625.00</b>
18M Plate - for 210mm x 210mm box (8x8)	<b>S7618</b>	<b>.01 648.00</b>	<b>S7618</b>	<b>.27 2128.00</b>

111

## Smart Plates with frames Graphite Gray, Cocoa Brown and Ice Silver

Description	Graphite Gray		Cocoa Brown		Ice Silver	
	Cat no.	Price (Rs.)	Cat no.	Price (Rs.)	Cat no.	Price (Rs.)
1M Plate	<b>S7601</b>	<b>.23 206.00</b>	<b>S7601</b>	<b>.25 206.00</b>	<b>S7601</b>	<b>.03 206.00</b>
2M Plate	<b>S7602</b>	<b>.23 206.00</b>	<b>S7602</b>	<b>.25 206.00</b>	<b>S7602</b>	<b>.03 206.00</b>
3M Plate	<b>S7633</b>	<b>.23 232.00</b>	<b>S7633</b>	<b>.25 232.00</b>	<b>S7633</b>	<b>.03 232.00</b>
1M Plate	<b>S7631</b>	<b>.23 232.00</b>	<b>S7631</b>	<b>.25 232.00</b>	<b>S7631</b>	<b>.03 232.00</b>
2M Plate	<b>S7632</b>	<b>.23 232.00</b>	<b>S7632</b>	<b>.25 232.00</b>	<b>S7632</b>	<b>.03 232.00</b>
4M Plate	<b>S7604</b>	<b>.23 253.00</b>	<b>S7604</b>	<b>.25 253.00</b>	<b>S7604</b>	<b>.03 253.00</b>
6M Plate	<b>S7606</b>	<b>.23 423.00</b>	<b>S7606</b>	<b>.25 423.00</b>	<b>S7606</b>	<b>.03 423.00</b>
8M Plate	<b>S7608</b>	<b>.23 504.00</b>	<b>S7608</b>	<b>.25 504.00</b>	<b>S7608</b>	<b>.03 504.00</b>
8M(V) Plate	<b>S7609</b>	<b>.23 590.00</b>	<b>S7609</b>	<b>.25 590.00</b>	<b>S7609</b>	<b>.03 590.00</b>
12M Plate	<b>S7612</b>	<b>.23 699.00</b>	<b>S7612</b>	<b>.25 699.00</b>	<b>S7612</b>	<b>.03 699.00</b>
18M Plate	<b>S7618</b>	<b>.23 914.00</b>	<b>S7618</b>	<b>.25 914.00</b>	<b>S7618</b>	<b>.03 914.00</b>

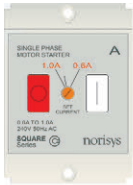

S725A .01

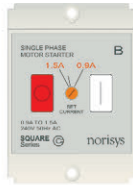

S725B .01

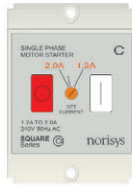

S725C .01

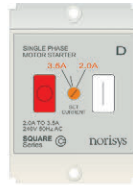

S725D .01

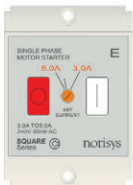

S725E .01

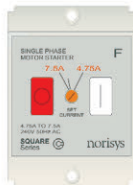

S725F .01

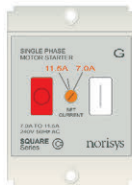

S725G .01



S725H .01

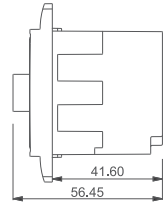

S725J .01



# SQUARE Series

## Single Phase Motor Starters Screw-mounting type - Frost White

Cat no.	Description		Price (Rs.)
<b>S725A .01</b>	Motor Starter 0.60 A - 1.00 A	1/8 HP Pump	<b>744.00</b>
<b>S725B .01</b>	Motor Starter 0.90 A - 1.50 A	1/4 HP Pump	<b>744.00</b>
<b>S725C .01</b>	Motor Starter 1.20 A - 2.00 A	1/3 HP Pump	<b>744.00</b>
<b>S725D .01</b>	Motor Starter 2.00 A - 3.50 A	1/2 HP Pump	<b>744.00</b>
<b>S725E .01</b>	Motor Starter 3.00 A - 5.00 A	3/4 HP Pump	<b>744.00</b>
<b>S725F .01</b>	Motor Starter 4.75 A - 7.50 A	1 Ton AC	<b>744.00</b>
<b>S725G .01</b>	Motor Starter 7.00 A - 11.50 A	1.5 Ton AC	<b>744.00</b>
<b>S725H .01</b>	Motor Starter 11.00 A - 18.00 A	2 Ton AC	<b>776.00</b>
<b>S725J .01</b>	Motor Starter 16.00 A - 25.00 A	2.5 Ton AC	<b>844.00</b>



STTSP06  
.01



STTSP10  
.01



STTSP16  
.01



STTSP20  
.01



STTSP25  
.01



STTSP32  
.01

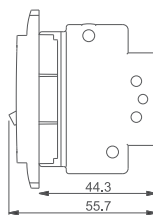

STTDP06 .01



STTDP10 .01



STTDP16 .01



STTDP20 .01

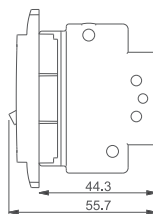

STTDP25 .01



STTDP32 .01



SLBDP32 .01



SLBDP50 .01

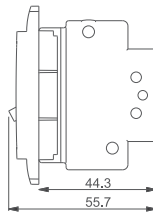



# SQUARE Series

## Tiny MCBs - Screw Mounting Type Frost White

Cat no.	Description	Price (Rs.)
<b>STTSP06 .01</b>	Tiny MCB Single Pole 6A	<b>372.00</b>
<b>STTSP10 .01</b>	Tiny MCB Single Pole 10A	<b>372.00</b>
<b>STTSP16 .01</b>	Tiny MCB Single Pole 16A	<b>372.00</b>
<b>STTSP20 .01</b>	Tiny MCB Single Pole 20A	<b>372.00</b>
<b>STTSP25 .01</b>	Tiny MCB Single Pole 25A	<b>372.00</b>
<b>STTSP32 .01</b>	Tiny MCB Single Pole 32A	<b>372.00</b>
<b>STTDP06 .01</b>	Tiny MCB Double Pole 6A	<b>925.00</b>
<b>STTDP10 .01</b>	Tiny MCB Double Pole 10A	<b>925.00</b>
<b>STTDP16 .01</b>	Tiny MCB Double Pole 16A	<b>925.00</b>
<b>STTDP20 .01</b>	Tiny MCB Double Pole 20A	<b>925.00</b>
<b>STTDP25 .01</b>	Tiny MCB Double Pole 25A	<b>925.00</b>
<b>STTDP32 .01</b>	Tiny MCB Double Pole 32A	<b>925.00</b>

115

## Tiny Load Break Switch - Screw Mounting Type Frost White

<b>SLBDP32 .01</b>	Tiny Load Break Switch Double Pole 32A	<b>790.00</b>
<b>SLBDP50 .01</b>	Tiny Load Break Switch Double Pole 50A	<b>864.00</b>

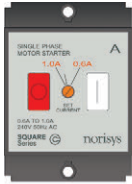

S725A .23

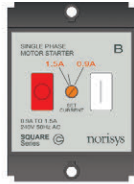

S725B .23

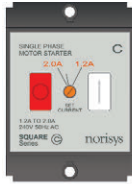

S725C .23



S725D .23

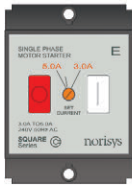

S725E .23

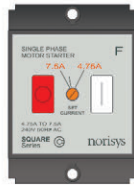

S725F .23



S725G .23



S725H .23

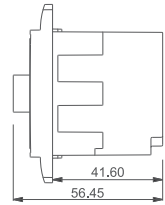

S725J .23

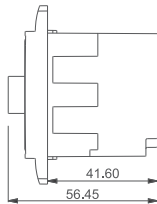

# SQUARE Series

## Single Phase Motor Starters Screw-mounting type - Graphite Gray

Cat no.	Description		Price (Rs.)
<b>S725A .23</b>	Motor Starter 0.60 A - 1.00 A	1/8 HP Pump	<b>902.00</b>
<b>S725B .23</b>	Motor Starter 0.90 A - 1.50 A	1/4 HP Pump	<b>902.00</b>
<b>S725C .23</b>	Motor Starter 1.20 A - 2.00 A	1/3 HP Pump	<b>902.00</b>
<b>S725D .23</b>	Motor Starter 2.00 A - 3.50 A	1/2 HP Pump	<b>902.00</b>
<b>S725E .23</b>	Motor Starter 3.00 A - 5.00 A	3/4 HP Pump	<b>902.00</b>
<b>S725F .23</b>	Motor Starter 4.75 A - 7.50 A	1 Ton AC	<b>902.00</b>
<b>S725G .23</b>	Motor Starter 7.00 A - 11.50 A	1.5 Ton AC	<b>902.00</b>
<b>S725H .23</b>	Motor Starter 11.00 A - 18.00 A	2 Ton AC	<b>938.00</b>
<b>S725J .23</b>	Motor Starter 16.00 A - 25.00 A	2.5 Ton AC	<b>1021.00</b>



STTSP06 .23



STTSP10 .23



STTSP16 .23



STTSP20 .23



STTSP25 .23



STTSP32 .23

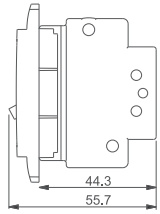

STTDP06 .23



STTDP10 .23



STTDP16 .23



STTDP20 .23

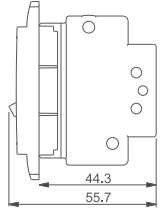

STTDP25 .23



STTDP32 .23

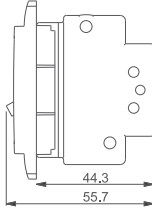

SLBDP32 .23



SLBDP50 .23

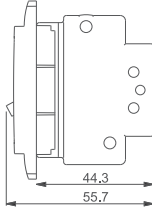

# SQUARE Series

## Tiny MCBs - Screw Mounting Type Graphite Gray

Cat no.	Description	Price (Rs.)
<b>STTSP06 .23</b>	Tiny MCB Single Pole 6A	<b>450.00</b>
<b>STTSP10 .23</b>	Tiny MCB Single Pole 10A	<b>450.00</b>
<b>STTSP16 .23</b>	Tiny MCB Single Pole 16A	<b>450.00</b>
<b>STTSP20 .23</b>	Tiny MCB Single Pole 20A	<b>450.00</b>
<b>STTSP25 .23</b>	Tiny MCB Single Pole 25A	<b>450.00</b>
<b>STTSP32 .23</b>	Tiny MCB Single Pole 32A	<b>450.00</b>
<b>STTDP06 .23</b>	Tiny MCB Double Pole 6A	<b>1120.00</b>
<b>STTDP10 .23</b>	Tiny MCB Double Pole 10A	<b>1120.00</b>
<b>STTDP16 .23</b>	Tiny MCB Double Pole 16A	<b>1120.00</b>
<b>STTDP20 .23</b>	Tiny MCB Double Pole 20A	<b>1120.00</b>
<b>STTDP25 .23</b>	Tiny MCB Double Pole 25A	<b>1120.00</b>
<b>STTDP32 .23</b>	Tiny MCB Double Pole 32A	<b>1120.00</b>

119

## Tiny Load Break Switch - Screw Mounting Type Graphite Gray

<b>SLBDP32 .23</b>	Tiny Load Break Switch Double Pole 32A	<b>956.00</b>
<b>SLBDP50 .23</b>	Tiny Load Break Switch Double Pole 50A	<b>1045.00</b>

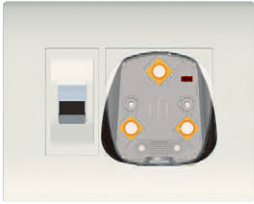

PU3MFT .01

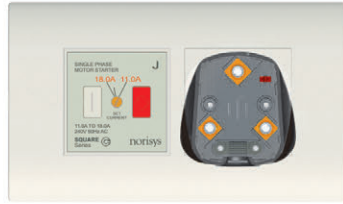

PU4MFT .01



PU6MFT .01



PU3MBT .01



PU4MBT .01



PU6MBT .01

# SQUARE Series

## Pre-wired Power Units Frost White

Cat no.	Description	Price (Rs.)
<b>PU3MFT .01</b>	Power Unit Flush Type with MCB + 25A Plug & Socket	<b>1274.00</b>
<b>PU3MBT .01</b>	Power Unit in Surface Box with MCB + 25A Plug & Socket	<b>1395.00</b>
<b>PU4MFT .01</b>	Power Unit Flush Type with Starter + 25A Plug & Socket	<b>1740.00</b>
<b>PU4MBT .01</b>	Power Unit in Surface Box with Starter + 25A Plug & Socket	<b>1870.00</b>
<b>PU6MFT .01</b>	Power Unit Flush Type with MCB + Starter + 25A Plug & Socket	<b>2754.00</b>
<b>PU6MBT .01</b>	Power Unit in Surface Box MCB + Starter + 25A Plug & Socket	<b>2824.00</b>



MB501 .01  
SB501 .01



MB503 .01  
SB503 .01



MB504 .01  
SB504 .01



MB506 .01  
SB506 .01



MB508 .01  
SB508 .01



MB509 .01  
SB509 .01

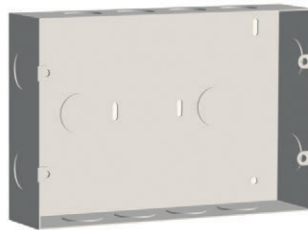

MB512 .01  
SB512 .01



SM702 .01



SM703 .01



SM704 .01

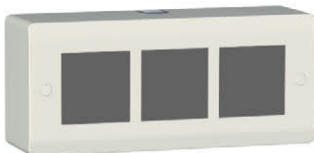

SM706 .01



# Wiring Boxes

## Superior Anti-Rust Stainless Steel Boxes Suitable for CUBE Series & SQUARE Series

Cat no.	Description	Suitable plate size in Cube Series	Suitable plate size in Square Series	Price (Rs.)
<b>SB501 .01</b>	75mm X 75mm X 50mm (3x3)	1M, 2M	1M, 2M	<b>199.00</b>
<b>SB503 .01</b>	100mm X 75mm X 50mm (4x3)	3M	1M, 2M, 3M	<b>235.00</b>
<b>SB504 .01</b>	135mm X 75mm X 50mm (5x3)	4M	4M	<b>281.00</b>
<b>SB506 .01</b>	210mm X 75mm X 50mm (8x3)	6M, 8M	6M	<b>377.00</b>
<b>SB508 .01</b>	230mm X 75mm X 50mm (9x3)	8M	8M	<b>427.00</b>
<b>SB509 .01</b>	135mm X 140mm X 50mm (5x5)	8M	8M	<b>427.00</b>
<b>SB512 .01</b>	140mm X 210mm X 50mm (8x6)	12M, 14M	12M	<b>571.00</b>
<b>SB521 .01</b>	210mm X 210mm X 50mm (8x8)	21M	18M	<b>722.00</b>

## Metal Boxes Suitable for CUBE Series & SQUARE Series

123

<b>MB501 .01</b>	75mm X 75mm X 50mm (3x3)	1M, 2M	1M, 2M	<b>128.00</b>
<b>MB503 .01</b>	100mm X 75mm X 50mm (4x3)	3M	1M, 2M, 3M	<b>158.00</b>
<b>MB504 .01</b>	135mm X 75mm X 50mm (5x3)	4M	4M	<b>192.00</b>
<b>MB506 .01</b>	210mm X 75mm X 50mm (8x3)	6M, 8M	6M	<b>270.00</b>
<b>MB508 .01</b>	230mm X 75mm X 50mm (9x3)	8M	8M	<b>303.00</b>
<b>MB509 .01</b>	135mm X 140mm X 50mm (5x5)	8M	8M	<b>303.00</b>
<b>MB512 .01</b>	140mm X 210mm X 50mm (8x6)	12M, 14M	12M	<b>430.00</b>
<b>MB521 .01</b>	210mm X 210mm X 50mm (8x8)	21M	18M	<b>548.00</b>

## Plastic Surface Boxes Frost White

<b>SM702 .01</b>	2 Module Surface Box 94mm X 94mm X 60mm (3.5 x 3.5)	<b>232.00</b>
<b>SM703 .01</b>	3 Module Surface Box 118mm X 94mm X 60mm (4.5 x 3.5)	<b>262.00</b>
<b>SM704 .01</b>	4 Module Surface Box 150mm X 94mm X 60mm (6 x 3.5)	<b>306.00</b>
<b>SM706 .01</b>	6 Module Surface Box 205mm X 94mm X 60mm (8 x 3.5)	<b>363.00</b>

# CUBE Series exploded view

Solid, heavy products with fine precision engineering resulting in trouble-free operation.

Cover plate can be snap fit onto the frames after final painting of walls.

Strong and precise locks for sturdy mounting and easy removal.

124

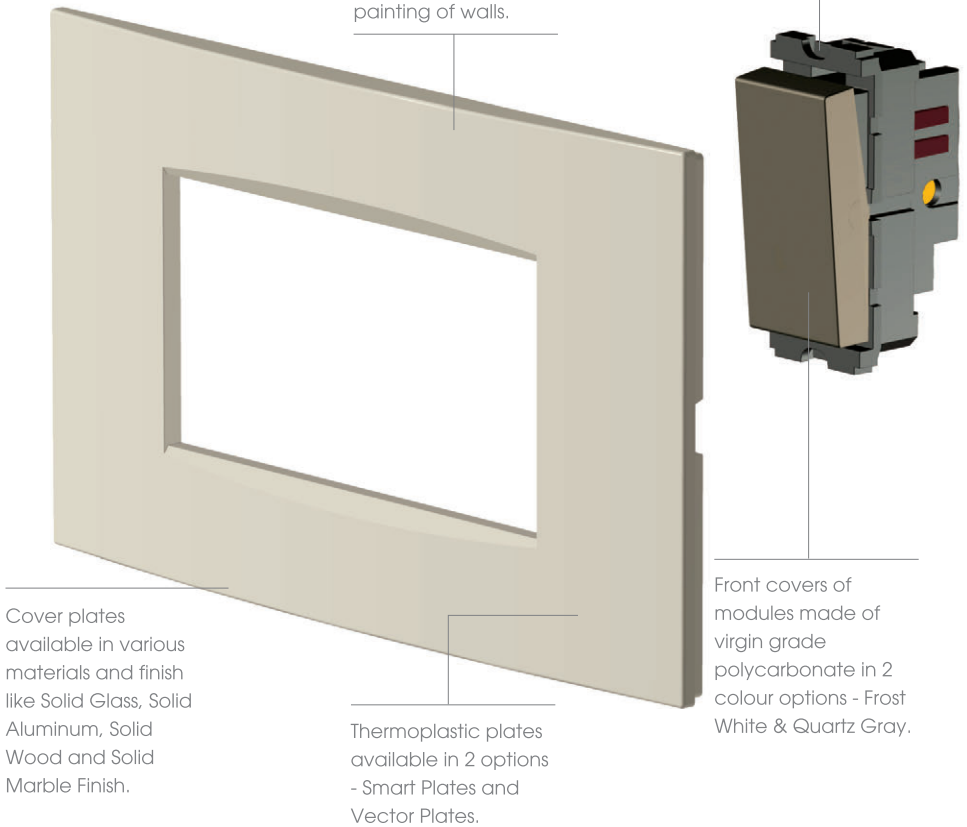

Thermoset material which can be seen in red colour is used inside to house the live metal parts. This material is extremely high heat resistant and does not melt on heating.

Sockets with elliptical spring loaded tubes for a firm and uniform grip on the plug pins ensuring unwavering contact.

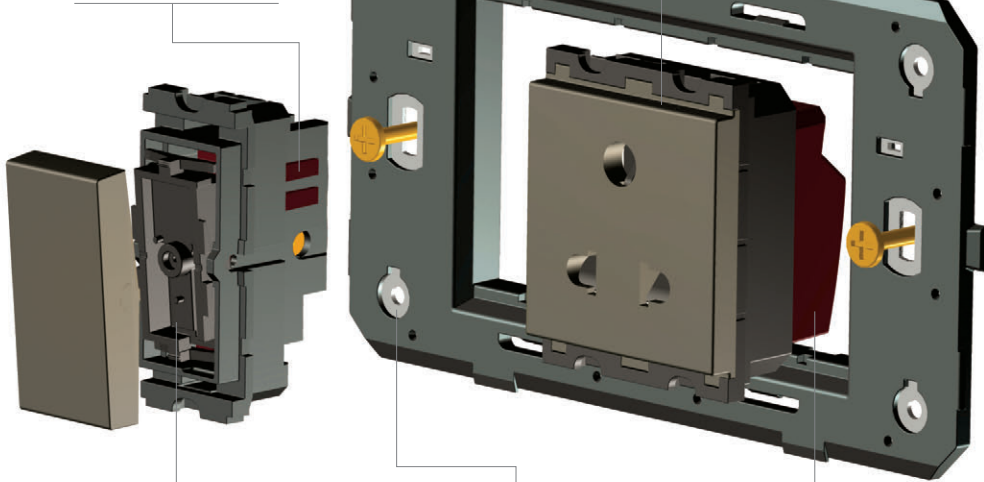

Inner shield for extra safety. It prevents the arcing from coming in contact with the front rocker. Also muffles the operating sound.

Bi-material frames that have high quality steel embedded inside thermoplastic. A result of advanced engineering, this combination leads to extra stiffness and tight tolerances for mounting of modules.

Live metal parts in sockets are enclosed in a housing made of thermoset material which is extremely high heat resistant and is capable of handling higher operating currents.

## SQUARE Series exploded view

Time tested products which have evolved over a period of time - with the latest in technology.

Cover plate can be snap fit onto the frames after final painting of walls.

Modules are mounted on the frame using screws making it a fool-proof and durable mounting system.

126

Cover plates made from virgin grade, UV stabilized polycarbonate for a flawless glossy look that lasts longer.

Smart Plates that have a classic contour profile - a look unwavered by changes in fashion.

Front covers of modules made of virgin grade polycarbonate.

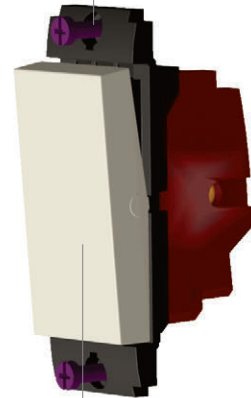
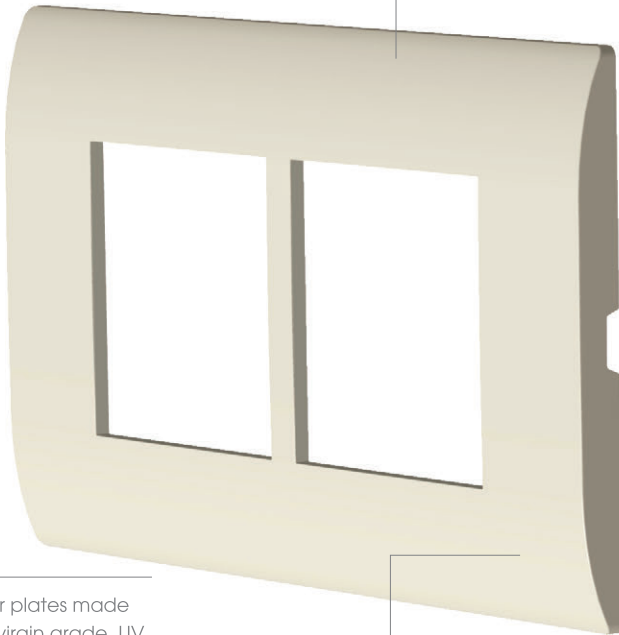

Thermoset material which can be seen in red colour is used inside to house the live metal parts. This material is extremely high heat resistant and does not melt on heating.

Sockets with elliptical spring loaded tubes for a firm and uniform grip on the plug pins ensuring unwavering contact.

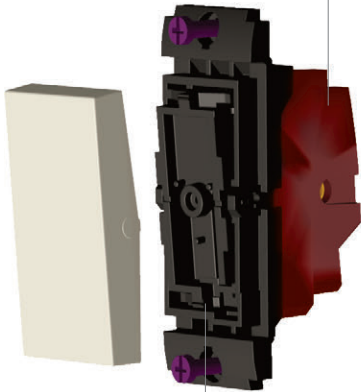

Inner shield for extra safety. It prevents the arcing from coming in contact with the front rocker. Also muffles the operating sound.

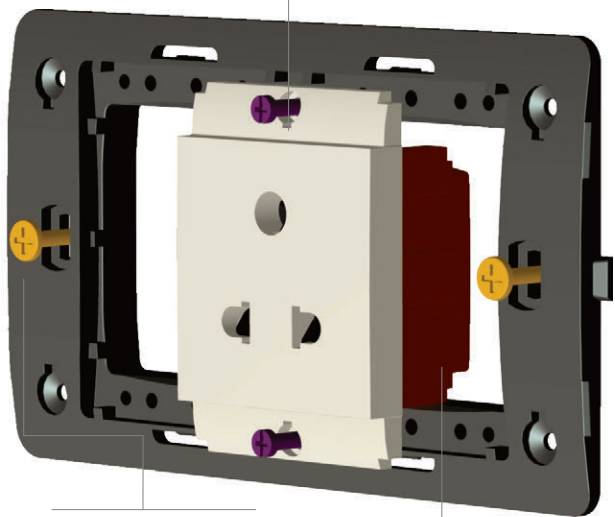

Tough frames that have unique locator slots that guide the modules to its accurate mounting location - thus ensuring uniform gaps in fitment. Steel channels at the rear give additional strength to the frames for rigidity.

Live metal parts in sockets are enclosed in thermoset material that is extremely high heat resistant and is capable of handling higher operating currents.







# norisys<sup>®</sup>



@All rights reserved, Norisys is a registered trademark.

Wiring of electrical products should be done by trained professionals following all safety norms.

@Alle Rechte vorbehalten, Norisys ist eine eingetragene Marke.

Elektroinstallationen dürfen nur von entsprechend ausgebildeten Fachkräften unter Beachtung der maßgeblichen Sicherheitsrichtlinien vorgenommen werden.

## Headquarters

Norisys Technology Private Limited  
14/3 Mathura Road  
Faridabad - 121 003, India

CIN: U31101DL1987PTC026630

Toll free: 1 800 11 1617

Tel: +91 11 49126360, 42657036

WhatsApp: +91 95 600 24771

Email: [sales@norisys.com](mailto:sales@norisys.com)

Web: [www.norisys.com](http://www.norisys.com)