

SIMPLIFIED  
INTELLIGENT  
LIGHTING

2 0 2 3



| **Select** 

Edition  
September 2023

A hand is shown from the right side, holding a glowing white ring. The ring is illuminated from within, creating a bright white glow. The text "Lighting in your hands your way" is centered inside the ring. The background is dark, making the glowing ring and the hand stand out.

Lighting  
in your hands  
your way

0 6

ABOUT

About Litomatic & R&D

2 0

MUSEUM

Magic Gobo Track Light

2 7

INTENSE

Antiglare Spotlight

0 9

SELECT

About Select Series

2 2

IGNITE

Magnetic Hanging Downlight

2 8

SPARO

Minimal Spotlight

1 0

PRESENCE

Our Presence Across India

2 3

DESIRE

Magnetic Hanging Spotlight

3 0

METEOR

Polarized Wallwasher

1 2

PHANTOM

Antiglare Spotlight

2 4

IRIS

Magnetic Hanging Spotlight

3 1

BRISK

Antiglare Spotlight

1 4

SAPPHIRE

Pullout Spotlight

2 5

MAGIC

Magic Accessories

3 2

STEAM

Steam Proof Spotlight

1 6

MAGIC

Magnetic Track Series

2 6

ARROW

Minimal Spotlight

3 3

CLOUD

Steam Proof Spotlight

3 4

MUSCLE

Antiglare Spotlight

4 2

JOY

Cylinder Spotlight

4 8

MARVELL

Track Light

3 6

MIRACLE

Degree Adjustable Spotlight

4 3

ESTEEM

Movable Surface Cylinder Spotlight

4 9

VELLAR

Track Light

3 7

BEAM

Antiglare Spotlight

4 4

BULLET

Surface Cylinder Spotlight

5 0

ADORE

Laser Blade

3 8

MARSHALL

Movable Adjustable Spotlight

4 5

SHADE

Surface Cylinder Spotlight

5 2

REMOTE

Multifunctional Remote Controller

3 9

ABSOLUTE

Antiglare Downlight

4 6

PACE

Movable Surface Cylinder Spotlight

5 3

SCENE

Scene Mode Controller

4 0

ELAN

Laser Blade

4 7

HOPE

Mini Spotlight

5 4

CLIENTS

Our Clients



## About Litomatic

Established in the year 1992, Kardhar Electric Co. has been into the business of Electricals and Power Cables, fulfilling the demands of Construction Industry, Hotel Industry, Hospitals and Residence etc. With growing demand, we stepped into the LED market. "LITOMATIC", brings you to the world of Simplified Intelligent Lighting, the world which will make our lives more beautiful than ever before.

## Introduction

LITOMATIC, a company focused on Simplified Intelligent Lighting, aims to enhance our lives by offering innovative solutions. Recognizing the increasing demand for different color temperatures (CCT) and dimming capabilities in LED lights, we ventured into the world of smart LED lighting. However, we strongly believed that achieving CCT and dimming functionality should be effortless, reliable, and consistent across all age groups and applications. This conviction led us to develop and introduce LITOMATIC to the market in 2016.

Since then, technology has witnessed exponential growth globally, and we have embraced this evolution. As board members, we collectively brainstormed and conceived the concept of marketing Remote Controlled LED lights. This new feature allows users to control their LED lights using a remote, adding convenience and flexibility to the lighting experience.

It is our immense pleasure to introduce ourselves as the Pioneer in initiating the concept of Remote Controlled LED lights of it's kind since 2016.

Litomatic is a leading lighting brand in India, experiencing rapid growth. We boast 200+ dies and extrusion molds to meet robust demands and fuel our accelerated expansion. Our competent R&D team drives innovation, offering cutting-edge technology to our customers. With an in-house powder coating plant, we ensure excellent quality and superior finishes. Housed in a 60,000 sq. ft. facility, we have the infrastructure to deliver outstanding lighting solutions.

- These lights come with high efficiency and are flicker free.
- These lights work on communication protocol : RF 2.4G.
- These LED lights come with dimming range of 10% to 100%.
- These lights can achieve CCT from 2700k to 6500k smoothly.
- These lights have 4 various scene modes, which help you to get your customized or desired lighting ambience by just one press on the remote.

We are committed to continuously improving our products and incorporating cutting-edge technologies to meet the ever-evolving needs of our customers. We aim to make lighting simpler, smarter, and more beautiful than ever before.

### **Product Development & Design**

LITOMATIC's expertise shines in luminaire engineering, blending aesthetics and functionality for unrivalled brilliance. Our meticulous approach encompasses the precise selection of light sources, materials with optimal heat sink capacity, and cutting-edge technologies. With a keen focus on achieving the highest standard of lighting emission, each functional prototype serves as a catalyst for refining elements and orchestrating a seamless creative progression. Experience the alchemy of innovation as we illuminate the path to luminaire excellence.

### **Factory Innovations - Crafting Excellence**

At Litomatic, we are dedicated to delivering products that embody contemporary designs through exceptional craftsmanship. Our cautious material selection, accurate finishing, and continuous research and development ensure durable and reliable products that elevate the global market. Each creation harmoniously fuses structure, light, and architecture, challenging artistic boundaries.

### **Machining Center - Precision Meets Artistry**

Our cutting-edge machining centers enable us to achieve uncompromising quality, from grinding to precise processing. These high-precision machines play an indispensable role in crafting our finest products.

### **Exquisite Workmanship - Quality and Beauty**

Litomatic lamps are renowned for their superior quality and meticulous manufacturing. From mold manufacturing to die casting, we passionately uphold the highest standards of craftsmanship..

### **Seamless Assembly - Precision and Safety**

Our skilled staff follows strict procedures on electrical and mechanical assembly lines, guaranteeing compliance with regulations. We prioritize electrical safety checks, ensuring the utmost reliability of our luminaires.

### **Packing and Delivery - Global Excellence**

Every Litomatic product undergoes painstaking preparation and packaging, ready to be shipped worldwide. As a trusted brand, Litomatic delivers excellence to customers across numerous countries and regions.



## CRI Technology for Color Accuracy

Color accuracy is crucial in lighting, and the Color Rendering Index (CRI) helps assess how faithfully a light source reveals colors compared to natural light. LED lighting, with its different color temperatures and light variations, directly affects color accuracy. Opting for higher CRI-rated LEDs ensures more accurate color representation. Experience vibrant and true-to-life colors with Litomatic's advanced CRI technology.

## Glare-Free LED Lighting

At Litomatic, we prioritize the ultimate lighting experience with our precision-engineered anti-glare technology. Through meticulous control and innovative design, we ensure secondary optical refraction curves and superior electroplate treatment, resulting in flicker-free, high-performance lighting even in low-light conditions. With a generous beam angle of up to  $40^\circ$ , our luminaires create a serene and comfortable lighting atmosphere, allowing you to enjoy the illumination without any distracting glare.

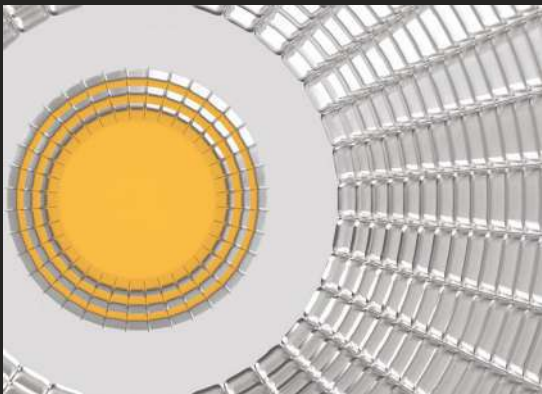
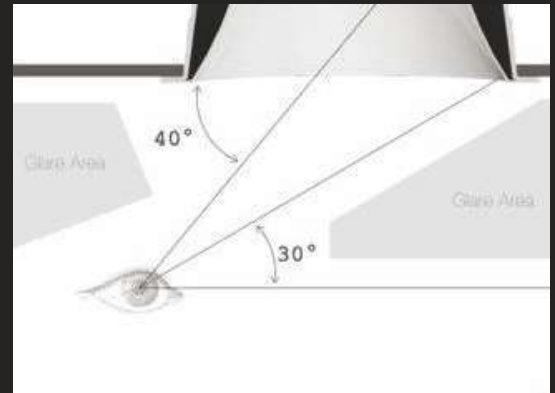

## LED Chips Illuminating Innovation

LED chips, the heart of modern lighting, revolutionize illumination with advanced technology. These compact semiconductor devices drive efficiency, superior color rendering, and remarkable longevity. Powering smart light bulbs and energy-saving solutions, LED chips redefine lighting experiences. Illuminate your space with efficiency and brilliance using Litomatic's high-quality LED chips.

## Brilliant COB Lighting

Experience flawless lighting with Litomatic's cutting-edge Chip-On-Board (COB) technology. Our COB fixtures deliver even natural light without double images, creating a clean and dimensionally rich lighting experience. Say goodbye to blurry edges and embrace Litomatic's superior COB lighting for captivating illumination.



# ABOUT **Select** SERIES

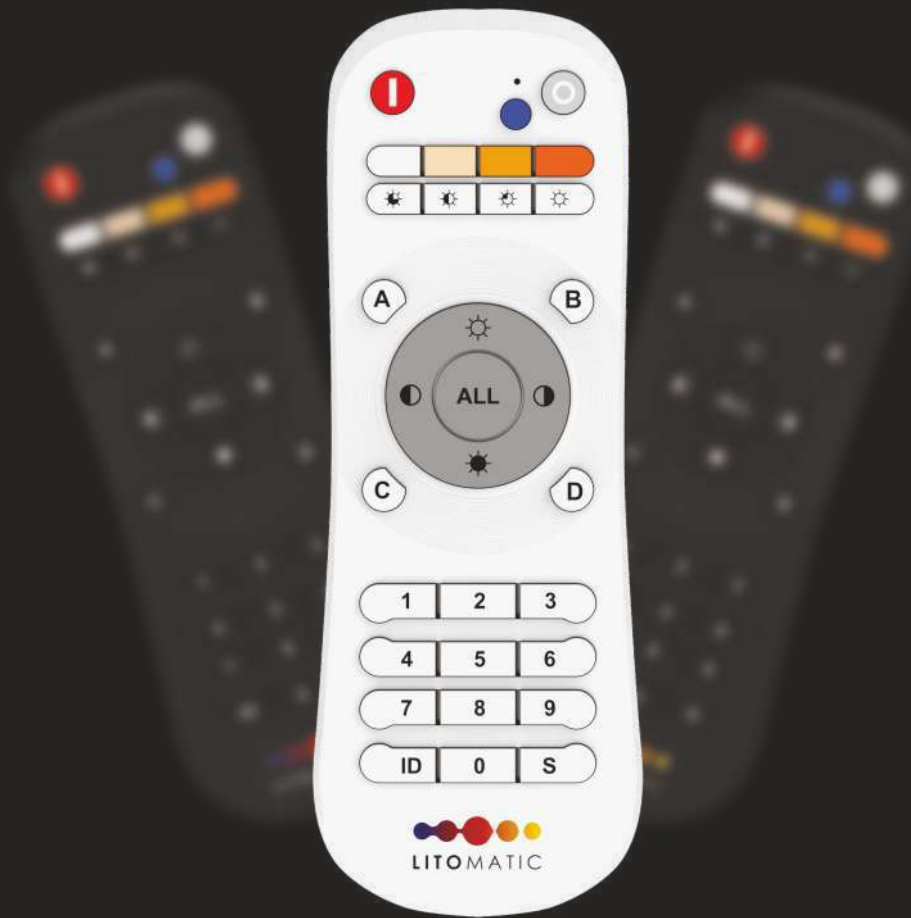

Introducing our new and exclusive line of product 'Litomatic Select'. These completely new range of lights provide excellent comfort while being extremely exquisite in looks. 'LITOMATIC SELECT', accompanies a wide range of Anti Glare LED lights that give a soothing effect to the eyes. These LED lights come with Premium Fixtures that stand apart as well as make a space look more exquisite. In addition, these installations are a very friendly choice for architects and interior designers on account of the seamless final output.

The add-on feature to the 'SELECT' series is the nature of optics that gives a top notch yield.



# OUR PRESENCE

100+ Cities, 300+ Dealers Across India

Ambikapur, Amravati, Amritsar, Agra, Ahmedabad, Ajmer, Anand, Aurangabad, Balgaum, Bareilly, Barmer, Barnala, Baroda, Begusarai, Begur, Bengaluru, Bharuch, Bhatinda, Bhavnagar, Bhawanipatna, Bhilai, Bhilwara, Bhopal, Bhubaneswar, Bikaner, Bokaro, Bilaspur, Chandigarh, Chennai, Cochin, Coimbatore, Dehradun, Dhule, Ernakulam, Faridabad, Firojabad, Gandhidham, Ghaziabad, Goa, Gopalpura, Gorakhpur, Gurgaon, Guwahati, Hanumangarh, Hazaribagh, Hoshiarpur, Hubli, Hyderabad, Indore, Jabalpur, Jaipur, Jalgaon, Jamnagar, Jhalandar, Jind, Jodhpur, kakinada, Karnal, Kendujhar, Khanna, Kishangarh, Kochi, Kolkata, Kota, Kottayam, Kozhikode, Lucknow, Ludhiana, Madurai, Mandsaur, Mangluru, Mathura, Meerut, Moga, Mumbai, Mysore, Nabha, Nagpur, Nashik, Navi Mumbai, Nawanshahr, New Delhi, Palakkad, Panipat, Patiala, Patna, Prayagraj, Pune, Raipur, Rajkot, Rajsamand, Ranchi, Ratlam, Satara, Secunderabad, Sikar, Siliguri, Siwan, Solapur, Surat, Taleigao, Thane, Thiruvananthapuram, Thrissur, Trichy, Trivandrum, Udaipur, Vadodara, Visakhapatnam, Wazirabad, Yelanahalli.

1<sup>st</sup>  
**PIONEER**  
with this CONCEPT  
SINCE **2016**



# PHANTOM

Antiglare Spotlight

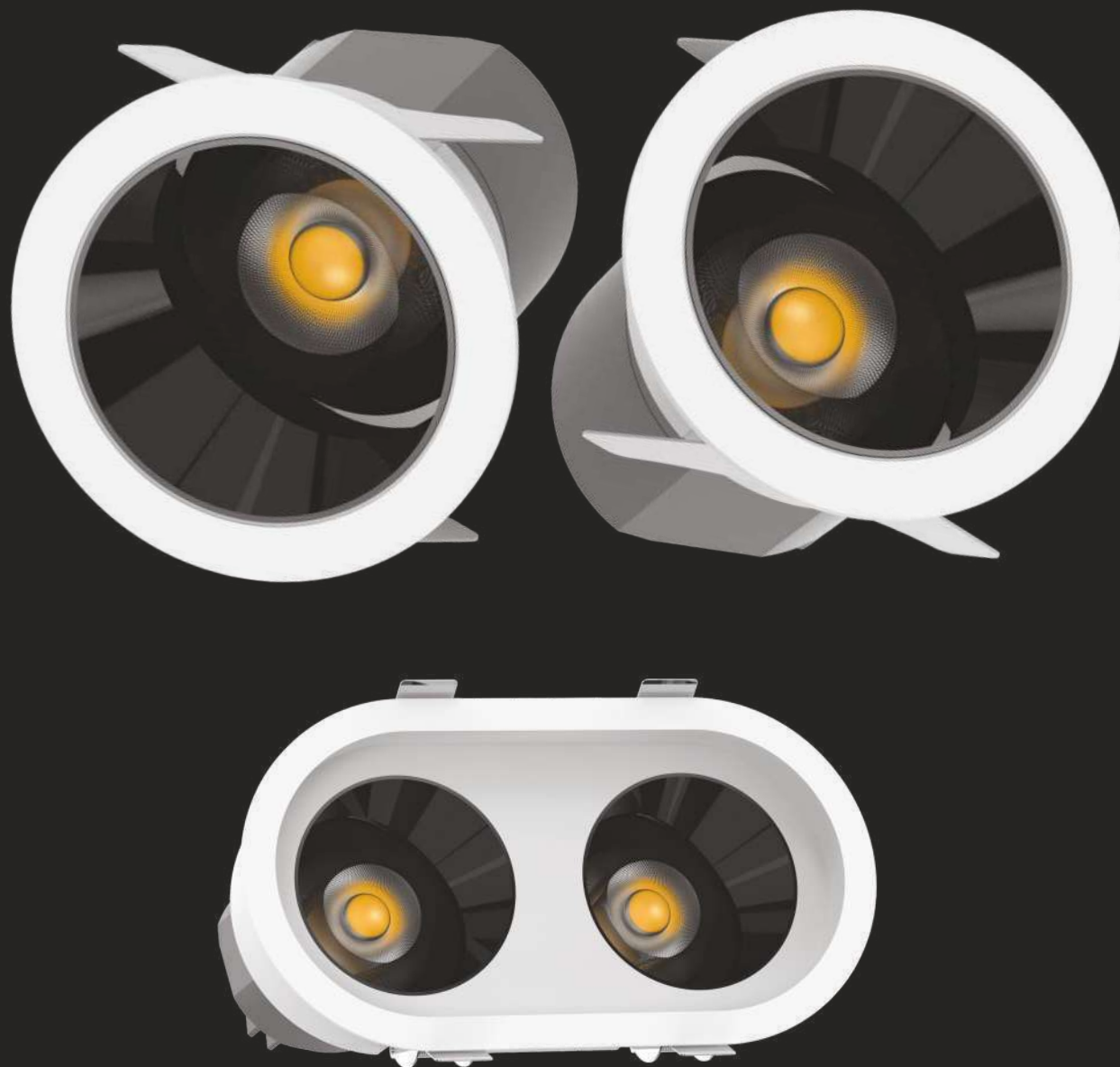

Anti Glare



Flicker Free



High Lumen



High CRI



Low UGR

3500k & 5000k Available on Request

[www.litomatic.com](http://www.litomatic.com) | 12

### Phantom Round

	WATT	DIMENSION	CUT OUT	CCT (K)	BEAM ANGLE	CRI	MATERIAL	LED BRAND
	7W	62mm x 80mm	55mm	3000k/4000k/6500k/ 3000-6500 (Tunable)	36°	80/90	Aluminum with Sand Finish Coating	Bridgelux/Litomatic/ Cree
	12W	84mm x 100mm	75mm	3000k/4000k/6500k/ 3000-6500 (Tunable)	36°	80/90	Aluminum with Sand Finish Coating	Bridgelux/Litomatic/ Cree
	20W	110mm x 122mm	95mm	3000k/4000k/6500k/ 3000-6500 (Tunable)	36°	80/90	Aluminum with Sand Finish Coating	Bridgelux/Litomatic/ Cree

### Phantom Double Round

	WATT	DIMENSION	CUT OUT	CCT (K)	BEAM ANGLE	CRI	MATERIAL	LED BRAND
	2 x 7W	114mm x 78mm x 84mm	125mm x 65mm	3000k/4000k/6500k/ 3000-6500 (Tunable)	36°	80/90	Aluminum with Sand Finish Coating	Bridgelux/Litomatic/ Cree
	2 x 12W	195mm x 105mm x 115mm	185mm x 95mm	3000k/4000k/6500k/ 3000-6500 (Tunable)	36°	80/90	Aluminum with Sand Finish Coating	Bridgelux/Litomatic/ Cree
	2 x 20W	240mm x 125mm x 133mm	230mm x 115mm	3000k/4000k/6500k/ 3000-6500 (Tunable)	36°	80/90	Aluminum with Sand Finish Coating	Bridgelux/Litomatic/ Cree

### Phantom Trimless Round

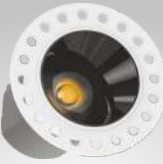
	WATT	DIMENSION	CUT OUT	CCT (K)	BEAM ANGLE	CRI	MATERIAL	LED BRAND
	7W	53mm x 80mm	53mm	3000k/4000k/6500k/ 3000-6500 (Tunable)	36°	80/90	Aluminum with Sand Finish Coating	Bridgelux/Litomatic/ Cree
	12W	73mm x 100mm	73mm	3000k/4000k/6500k/ 3000-6500 (Tunable)	36°	80/90	Aluminum with Sand Finish Coating	Bridgelux/Litomatic/ Cree
	20W	92mm x 122mm	92mm	3000k/4000k/6500k/ 3000-6500 (Tunable)	36°	80/90	Aluminum with Sand Finish Coating	Bridgelux/Litomatic/ Cree

### Phantom Square

	WATT	DIMENSION	CUT OUT	CCT (K)	BEAM ANGLE	CRI	MATERIAL	LED BRAND
	12W	85mm x 85mm x 110mm	75mm x 75mm	3000k/4000k/6500k/ 3000-6500 (Tunable)	36°	80/90	Aluminum with Sand Finish Coating	Cree/Goldi/Bridgelux

### Phantom Double Square

	WATT	DIMENSION	CUT OUT	CCT (K)	BEAM ANGLE	CRI	MATERIAL	LED BRAND
	2 x 12W	180mm x 90mm x 110mm	170mm x 80mm	3000k/4000k/6500k/ 3000-6500 (Tunable)	36°	80/90	Aluminum with Sand Finish Coating	Bridgelux/Litomatic/ Cree

### Phantom Pin Hole & Wall Washer

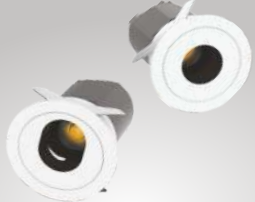
	WATT	DIMENSION	CUT OUT	CCT (K)	BEAM ANGLE	CRI	MATERIAL	LED BRAND
	12W	84mm x 100mm	75mm	3000k/4000k/6500k/ 3000-6500 (Tunable)	36°	80/90	Aluminum with Sand Finish Coating	Bridgelux/Litomatic Cree

# SAPPHIRE

Pullout Spotlight

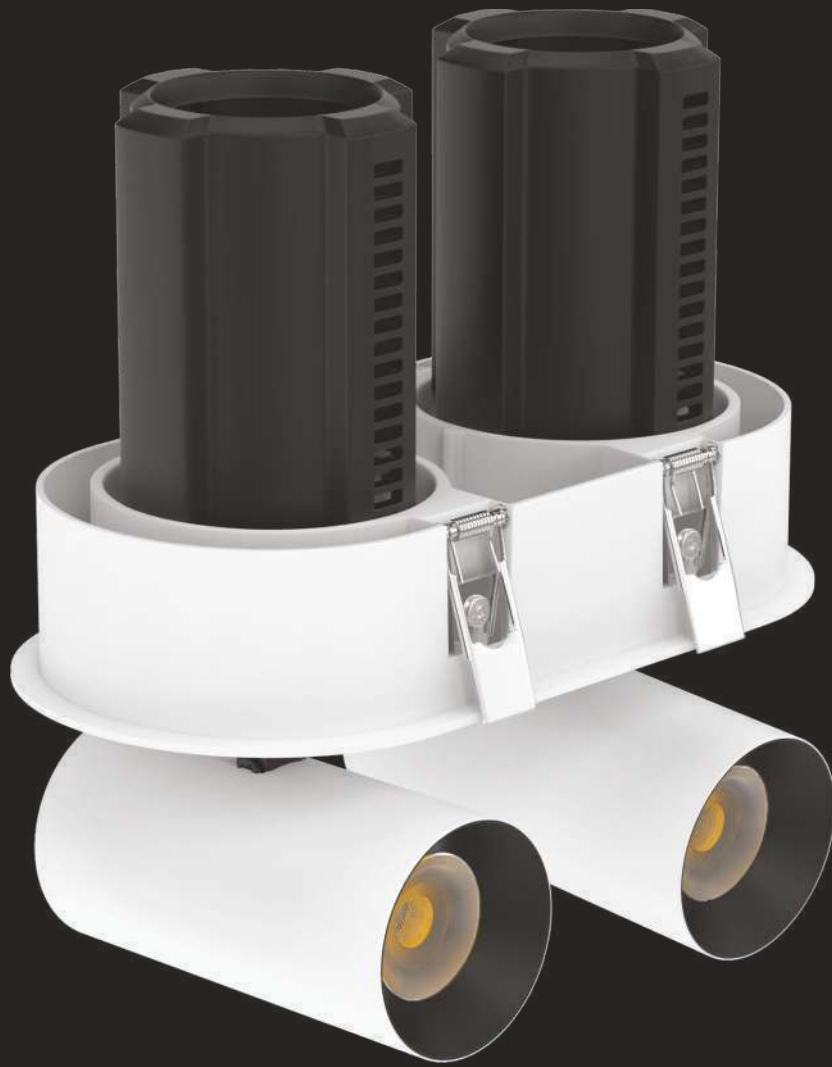

Anti Glare



Flicker Free



High Lumen



High CRI



Low UGR

3500k & 5000k Available on Request

[www.litomatic.com](http://www.litomatic.com) | 14



### Sapphire

	WATT	DIMENSION	CUT OUT	CCT (K)	BEAM ANGLE	CRI	MATERIAL	LED BRAND
	7W	62mm x 85mm	55mm	3000k/4000k/6500k/ 3000-6500 (Tunable)	36°	80/90	Aluminum with Sand Finish Coating	Bridgelux/Litomatic/ Cree
	12W	84mm x 104mm	75mm	3000k/4000k/6500k/ 3000-6500 (Tunable)	36°	80/90	Aluminum with Sand Finish Coating	Bridgelux/Litomatic/ Cree

### Sapphire Double

	WATT	DIMENSION	CUT OUT	CCT (K)	BEAM ANGLE	CRI	MATERIAL	LED BRAND
	2 x 7W	140mm x 78mm x 90mm	126mm x 65mm	3000k/4000k/6500k/ 3000-6500 (Tunable)	36°	80/90	Aluminum with Sand Finish Coating	Bridgelux/Litomatic/ Cree
	2 x 12W	195mm x 105mm x 115mm	180mm x 88mm	3000k/4000k/6500k/ 3000-6500 (Tunable)	36°	80/90	Aluminum with Sand Finish Coating	Bridgelux/Litomatic/ Cree

### Sapphire Trimless

	WATT	DIMENSION	CUT OUT	CCT (K)	BEAM ANGLE	CRI	MATERIAL	LED BRAND
	7W	55mm x 86mm	55mm	3000k/4000k/6500k/ 3000-6500 (Tunable)	36°	80/90	Aluminum with Sand Finish Coating	Bridgelux/Litomatic/ Cree
	12W	77mm x 104mm	77mm	3000k/4000k/6500k/ 3000-6500 (Tunable)	36°	80/90	Aluminum with Sand Finish Coating	Bridgelux/Litomatic/ Cree

# MAGIC

Magnetic Track Series

Hanging

Surface

Concealed

( 20 mm | 48 v )



Anti Glare



Flicker Free



High Lumen



High CRI



Low UGR

# TH20

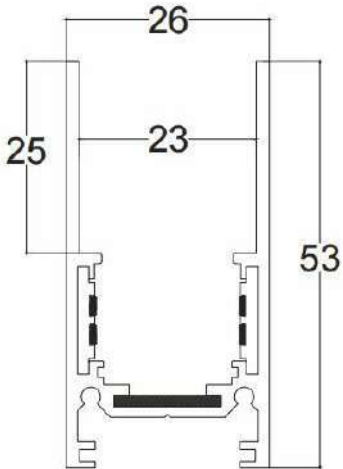

**SURFACE**

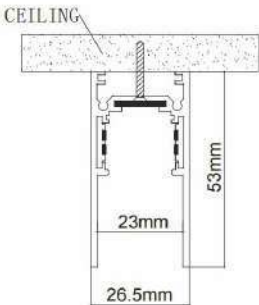

**SUSPENDED**

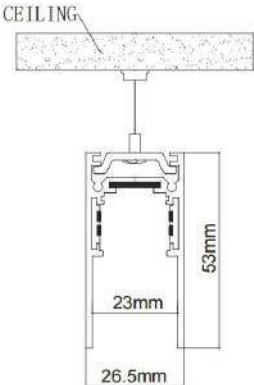

End Caps

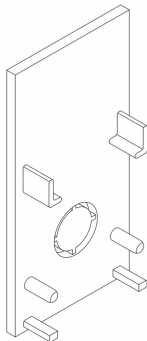

90° Corner (C to C)

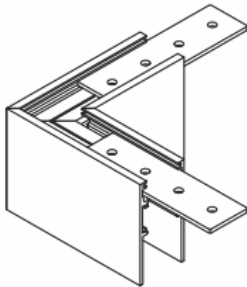



# TH20

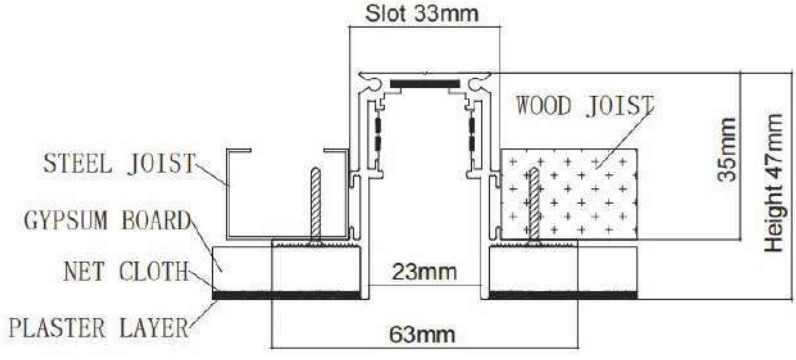
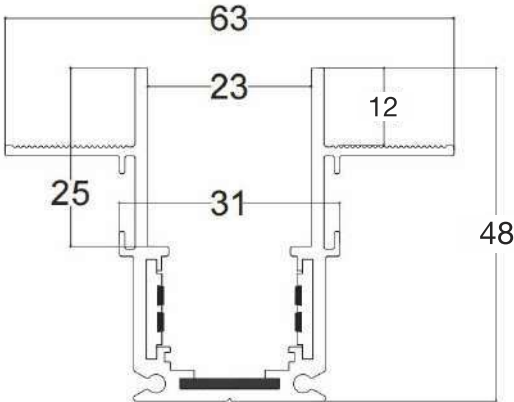

End Caps

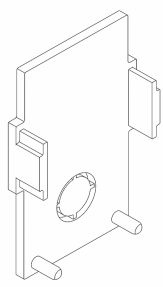

90° Corner (C to C)

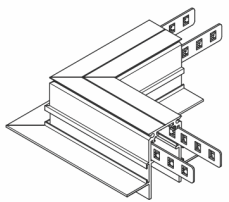

### Magic Laser Blade

	WATT	DIMENSION	CUT OUT	CCT (K)	BEAM ANGLE	CRI	MATERIAL	LED BRAND
	10W	112mm x 22mm x 25mm	-	3000k/4000k/6500k/ 3000-6500 (Tunable)	36°	80/90	Aluminum with Sand Finish Coating	Bridgelux/Litomatic/ Cree
	20W	220mm x 22mm x 25mm	-	3000k/4000k/6500k/ 3000-6500 (Tunable)	36°	80/90	Aluminum with Sand Finish Coating	Bridgelux/Litomatic/ Cree

### Magic Movable Laser Blade

	WATT	DIMENSION	CUT OU	CCT (K)	BEAM ANGLE	CRI	MATERIAL	LED BRAND
	10W	112mm x 22mm x 90mm	-	3000k/4000k/6500k/ 3000-6500 (Tunable)	36°	80/90	Aluminum with Sand Finish Coating	Bridgelux/Litomatic/ Cree
	20W	220mm x 22mm x 90mm	-	3000k/4000k/6500k/ 3000-6500 (Tunable)	36°	80/90	Aluminum with Sand Finish Coating	Bridgelux/Litomatic/ Cree

### Magic Track Light

	WATT	DIMENSION	CUT OUT	CCT (K)	BEAM ANGLE	CRI	MATERIAL	LED BRAND
	7W	35mm x 90mm x 105mm	-	3000k/4000k/6500k/ 3000-6500 (Tunable)	24/36°	80/90	Aluminum with Sand Finish Coating	Bridgelux/Litomatic/ Cree
	12W	48mm x 150mm x 120mm	-	3000k/4000k/6500k/ 3000-6500 (Tunable)	24/36/55°	80/90	Aluminum with Sand Finish Coating	Bridgelux/Litomatic/ Cree

### Magic Laser Wall Washer

	WATT	DIMENSION	CUT OUT	CCT (K)	BEAM ANGLE	CRI	MATERIAL	LED BRAND
	10W	132mm x 22mm x 42mm	-	3000k/4000k/6500k/ 3000-6500 (Tunable)	30°	80/90	Aluminum with Sand Finish Coating	Bridgelux/Litomatic/ Cree
	20W	246mm x 22mm x 42mm	-	3000k/4000k/6500k/ 3000-6500 (Tunable)	30°	80/90	Aluminum with Sand Finish Coating	Bridgelux/Litomatic/ Cree

### Magic Spot Light

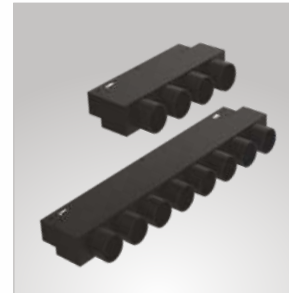
	WATT	DIMENSION	CUT OUT	CCT (K)	BEAM ANGLE	CRI	MATERIAL	LED BRAND
	8W	110mm x 22mm x 42mm	-	3000k/4000k/6500k/ 3000-6500 (Tunable)	30°	80/90	Aluminum with Sand Finish Coating	Bridgelux/Litomatic/ Cree
	16W	218mm x 22mm x 42mm	-	3000k/4000k/6500k/ 3000-6500 (Tunable)	30°	80/90	Aluminum with Sand Finish Coating	Bridgelux/Litomatic/ Cree

# MUSEUM

Magic Gobo Track Light



WATT	DIMENSION	CUT OUT	CCT (K)	BEAM ANGLE	CRI	MATERIAL	LED BRAND
12W	47mm x 115mm x 190mm	-	3000k/4000k/6500k/ 3000-6500 (Tunable)	25-36°	80/90	Aluminum with Sand Finish Coating	Bridgelux/Litomatic/ Cree



Anti Glare



Flicker Free



High Lumen



High CRI



Low UGR

3500k & 5000k Available on Request

Magic Diffused Linear Downlight

WATT	DIMENSION	CUT OUT	CCT (K)	BEAM ANGLE	CRI	MATERIAL	LED BRAND
10W	203mm x 22mm x 25 mm	-	3000k/4000k/6500k/ 3000-6500 (Tunable)	120°	80/90	Aluminum with Sand Finish Coating	Bridgelux/Litomatic/ Cree
20W	303mm x 22mm x 25mm	-	3000k/4000k/6500k/ 3000-6500 (Tunable)	120°	80/90	Aluminum with Sand Finish Coating	Bridgelux/Litomatic/ Cree

Magic Movable Diffused Downlight

WATT	DIMENSION	CUT OUT	CCT (K)	BEAM ANGLE	CRI	MATERIAL	LED BRAND
10W	203mm x 320mm x 90mm	-	3000k/4000k/6500k/ 3000-6500 (Tunable)	120°	80/90	Aluminum with Sand Finish Coating	Bridgelux/Litomatic/ Cree
20W	303mm x 320mm x 90mm	-	3000k/4000k/6500k/ 3000-6500 (Tunable)	120°	80/90	Aluminum with Sand Finish Coating	Bridgelux/Litomatic/ Cree

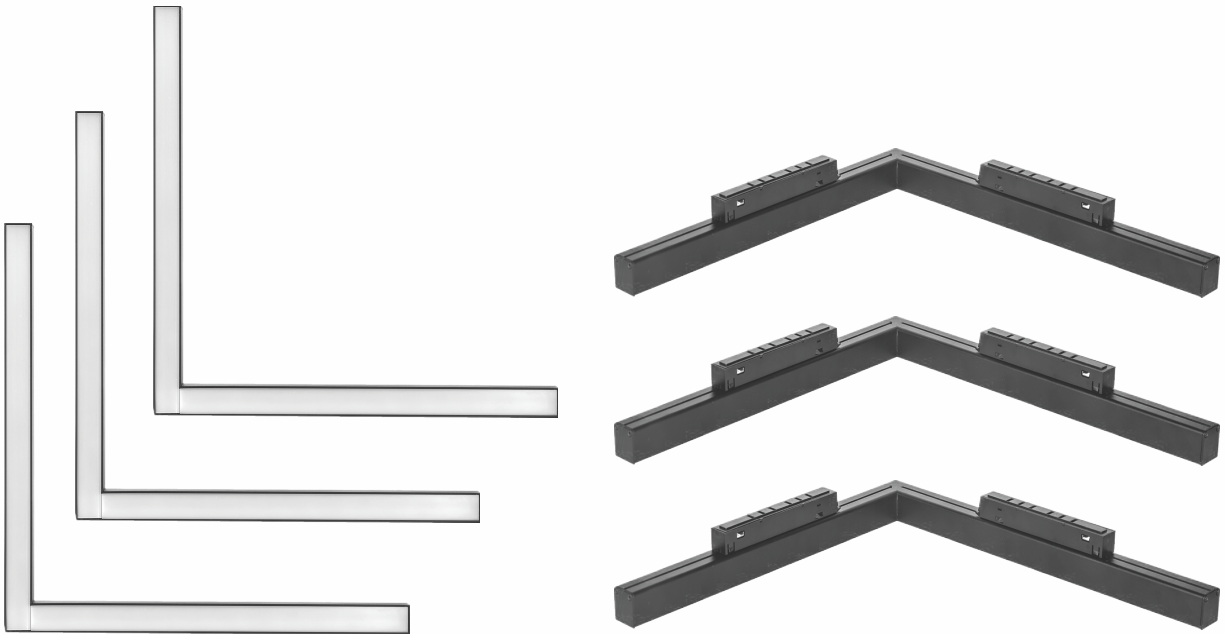

Magic Corner Diffused Downlight

WATT	DIMENSION	CUT OUT	CCT (K)	BEAM ANGLE	CRI	MATERIAL	LED BRAND
30W	300mm x 320mm x 25mm	-	3000k/4000k/6500k/ 3000-6500 (Tunable)	120°	80/90	Aluminum with Sand Finish Coating	Bridgelux/Litomatic/ Cree

# IGNITE

Magnetic Hanging Downlight



WATT	DIMENSION	CUT OUT	CCT (K)	BEAM ANGLE	CRI	MATERIAL	LED BRAND
8W	90mm x 75mm	-	3000k/4000k/6500k/ 3000-6500 (Tunable)	110°	80/90	Aluminum with Sand Finish Coating	Bridgelux/Litomatic/ Cree
15W	110mm x 75mm	-	3000k/4000k/6500k/ 3000-6500 (Tunable)	110°	80/90	Aluminum with Sand Finish Coating	Bridgelux/Litomatic/ Cree
22W	125mm x 75mm	-	3000k/4000k/6500k/ 3000-6500 (Tunable)	110°	80/90	Aluminum with Sand Finish Coating	Bridgelux/Litomatic/ Cree



Anti Glare



Flicker Free



High Lumen



High CRI



Low UGR

# DESIRE

Magnetic Hanging Spotlight

**NEW  
PRODUCT**

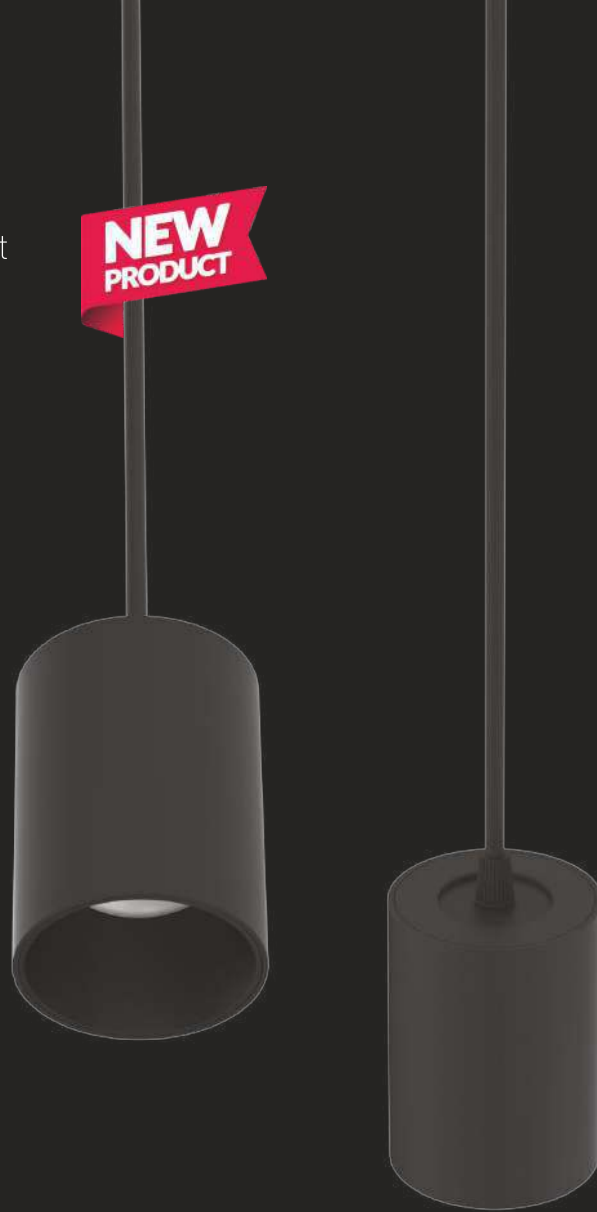

WATT	DIMENSION	CUT OUT	CCT (K)	BEAM ANGLE	CRI	MATERIAL	LED BRAND
7W	56mm x 75mm	-	3000k/4000k/6500k/ 3000-6500 (Tunable)	15/24/36/55°	80/90	Aluminum with Sand Finish Coating	Bridgelux/Litomatic/ Cree
12W	64mm x 85mm	-	3000k/4000k/6500k/ 3000-6500 (Tunable)	15/24/36/55°	80/90	Aluminum with Sand Finish Coating	Bridgelux/Litomatic/ Cree
20W	70mm x 95mm	-	3000k/4000k/6500k/ 3000-6500 (Tunable)	15/24/36/55°	80/90	Aluminum with Sand Finish Coating	Bridgelux/Litomatic/ Cree



Anti Glare



Flicker Free



High Lumen



High CRI



Low UGR

# IRIS

Magnetic Hanging Spotlight



WATT	DIMENSION	CUT OUT	CCT (K)	BEAM ANGLE	CRI	MATERIAL	LED BRAND
12W	40mm x 304.8mm	-	3000k/4000k/6500k/ 3000-6500 (Tunable)	24/36/55°	80/90	Aluminum with Sand Finish Coating	Bridgelux/Litomatic/ Cree



Anti Glare



Flicker Free



High Lumen



High CRI



Low UGR

# MAGIC

## Magic Accessories



TC Track



TH Track



TC & TH Corner



TC Power Supply



TH Power Supply



DC Straight Connector



Hanging Set



DC Connector

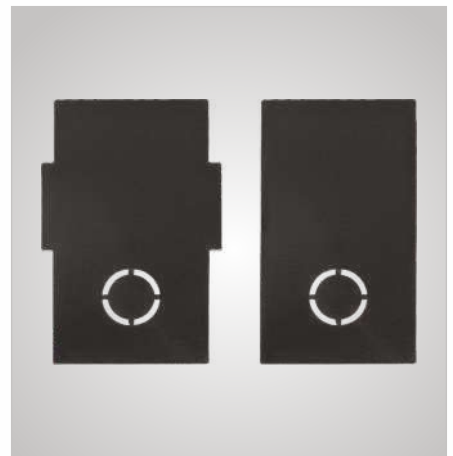

TC & TH End Caps



# ARROW

Minimal Spotlight



WATT	DIMENSION	CUT OUT	CCT (K)	BEAM ANGLE	CRI	MATERIAL	LED BRAND
7W	41mm x 85mm	34mm	3000k/4000k/6500k/ 3000-6500 (Tunable)	24/36/50°	80/90	Aluminum with Sand Finish Coating	Bridgelux/Litomatic/ Cree
12W	55mm x 100mm	47mm	3000k/4000k/6500k/ 3000-6500 (Tunable)	24/36/55°	80/90	Aluminum with Sand Finish Coating	Bridgelux/Litomatic/ Cree



Anti Glare



Flicker Free



High Lumen



High CRI



Low UGR

# INTENSE

Antiglare Spotlight

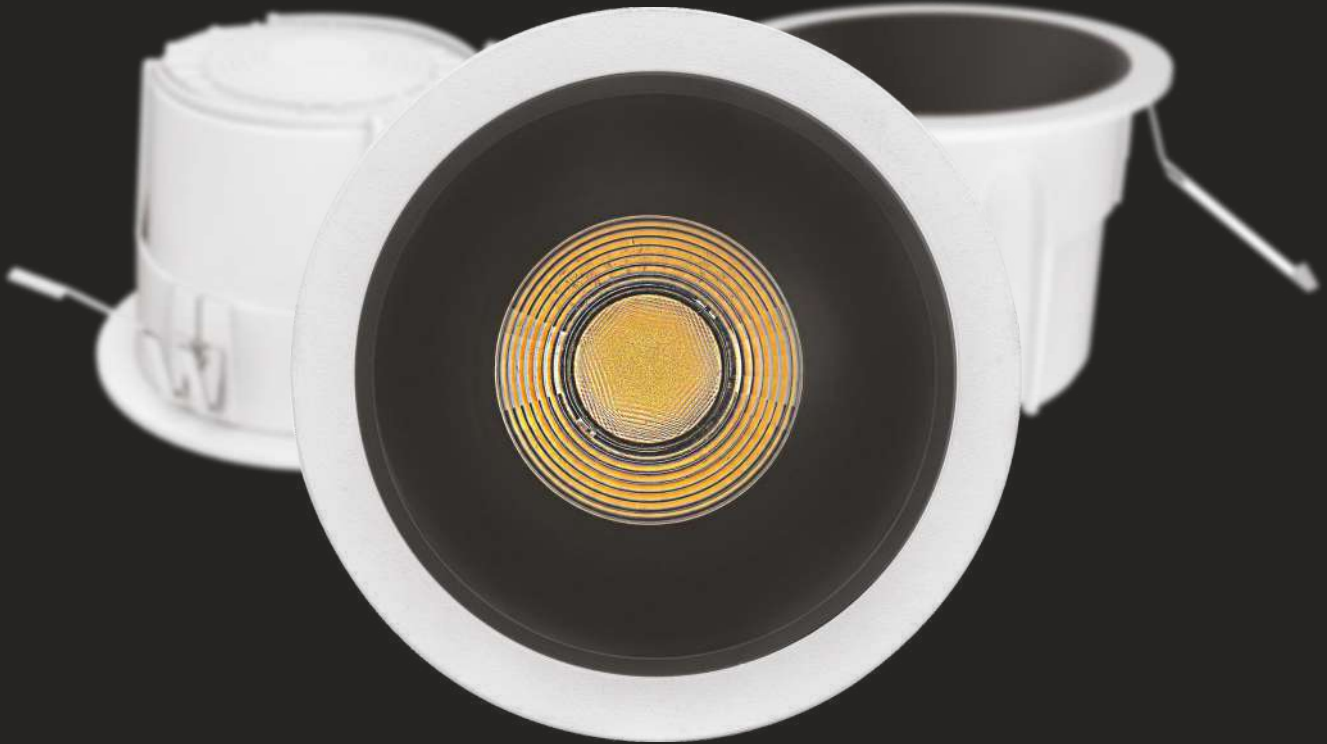

WATT	DIMENSION	CUT OUT	CCT (K)	BEAM ANGLE	CRI	MATERIAL	LED BRAND
7W	72mm x 48mm	62mm	3000k/4000k/6500k/ 3000-6500 (Tunable)	24/36/55°	80/90	Aluminum with Sand Finish Coating	Bridgelux/Litomatic/ Cree
12W	83mm x 58mm	73mm	3000k/4000k/6500k/ 3000-6500 (Tunable)	24/36/55°	80/90	Aluminum with Sand Finish Coating	Bridgelux/Litomatic/ Cree
20W	100mm x 73mm	85mm	3000k/4000k/6500k/ 3000-6500 (Tunable)	24/36/55°	80/90	Aluminum with Sand Finish Coating	Bridgelux/Litomatic/ Cree



Anti Glare



Flicker Free



High Lumen



High CRI



Low UGR

# SPARO

Minimal Spotlight



Anti Glare



Flicker Free



High Lumen



High CRI



Low UGR

3500k & 5000k Available on Request



Sparo Deep Hole

	WATT	DIMENSION	CUT OUT	CCT (K)	BEAM ANGLE	CRI	MATERIAL	LED BRAND
	12W	53mm x 66mm	45mm	3000k/4000k/6500k/ 3000-6500 (Tunable)	24/36/50°	80/90	Aluminum with Sand Finish Coating	Bridgelux/Litomatic/ Cree
	12W	70mm x 66mm	42mm	3000k/4000k/6500k/ 3000-6500 (Tunable)	24/36/50°	80/90	Aluminum with Sand Finish Coating	Bridgelux/Litomatic/ Cree

Sparo Pin Hole

	WATT	DIMENSION	CUT OUT	CCT (K)	BEAM ANGLE	CRI	MATERIAL	LED BRAND
	12W	53mm x 66mm	45mm	3000k/4000k/6500k/ 3000-6500 (Tunable)	24/36/50°	80/90	Aluminum with Sand Finish Coating	Bridgelux/Litomatic/ Cree
	12W	70mm x 66mm	42mm	3000k/4000k/6500k/ 3000-6500 (Tunable)	24/36/50°	80/90	Aluminum with Sand Finish Coating	Bridgelux/Litomatic/ Cree

# METEOR

Polarized Wallwasher



Single



Double

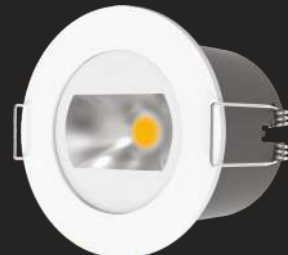

Spot

WATT	DIMENSION	CUT OUT	CCT (K)	BEAM ANGLE	CRI	MATERIAL	LED BRAND
12W	80mm x 59mm	70mm	3000k/4000k/6500k/ 3000-6500 (Tunable)	50°	80/90	Aluminum with Sand Finish Coating	Bridgelux/Litomatic/ Cree
12W	80mm x 59mm	70mm	3000k/4000k/6500k/ 3000-6500 (Tunable)	50°	80/90	Aluminum with Sand Finish Coating	Bridgelux/Litomatic/ Cree
12W	80mm x 59mm	70mm	3000k/4000k/6500k/ 3000-6500 (Tunable)	50°	80/90	Aluminum with Sand Finish Coating	Bridgelux/Litomatic/ Cree



Anti Glare



Flicker Free



High Lumen



High CRI



Low UGR

3500k & 5000k Available on Request

# BRISK

Antiglare Spotlight

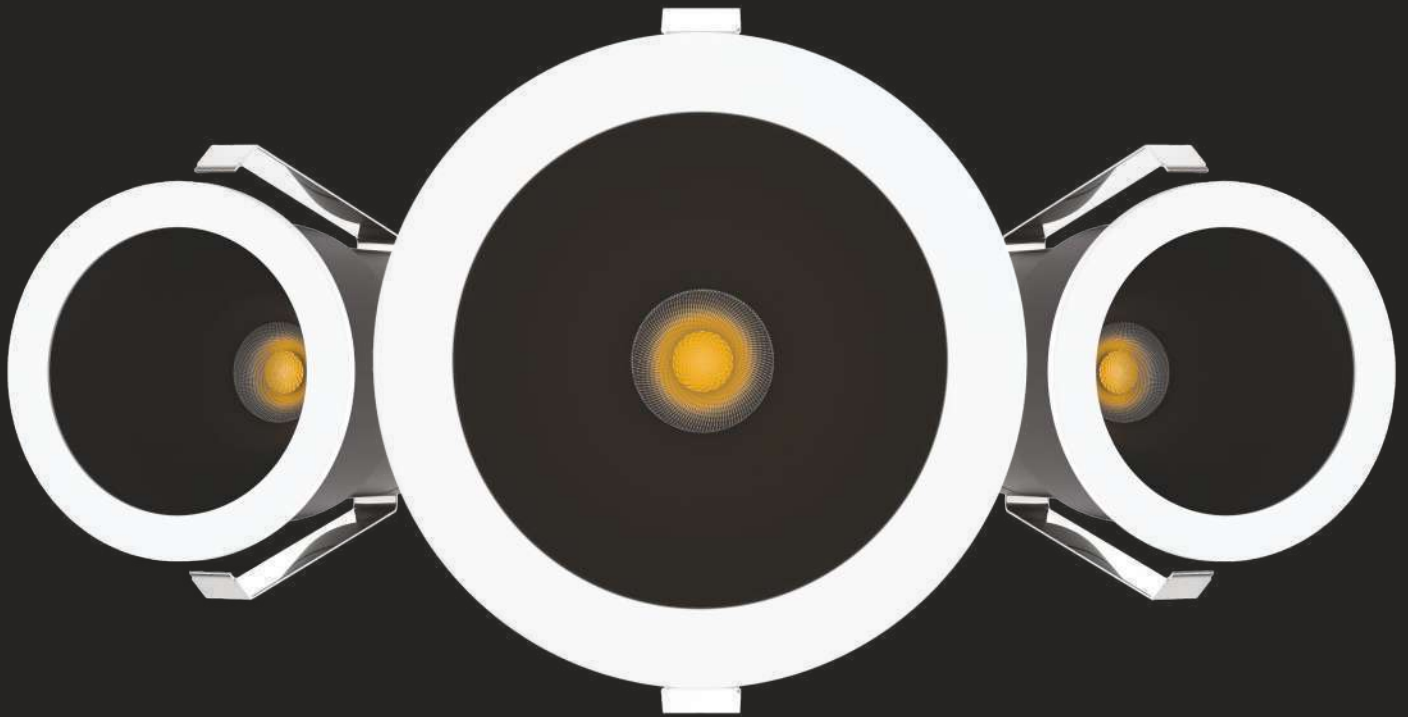

WATT	DIMENSION	CUT OUT	CCT (K)	BEAM ANGLE	CRI	MATERIAL	LED BRAND
7W	57mm x 72mm	48mm	3000k/4000k/6500k/ 3000-6500 (Tunable)	24/36/50°	80/90	Aluminum with Sand Finish Coating	Bridgelux/Litomatic/ Cree
12W	68mm x 80mm	58mm	3000k/4000k/6500k/ 3000-6500 (Tunable)	24/36/55°	80/90	Aluminum with Sand Finish Coating	Bridgelux/Litomatic/ Cree



Anti Glare



Flicker Free



High Lumen



High CRI



Low UGR

# STEAM

Steam Proof Spotlight



WATT	DIMENSION	CUT OUT	CCT (K)	BEAM ANGLE	CRI	MATERIAL	LED BRAND
12W	83mm x 58mm	72mm	3000k/4000k/6500k/ 3000-6500 (Tunable)	36°	80/90	Aluminum with Sand Finish Coating	Bridgelux/Litomatic/ Cree



Anti Glare



Flicker Free



High Lumen



High CRI



Low UGR



# CLOUD

Steam Proof Spotlight

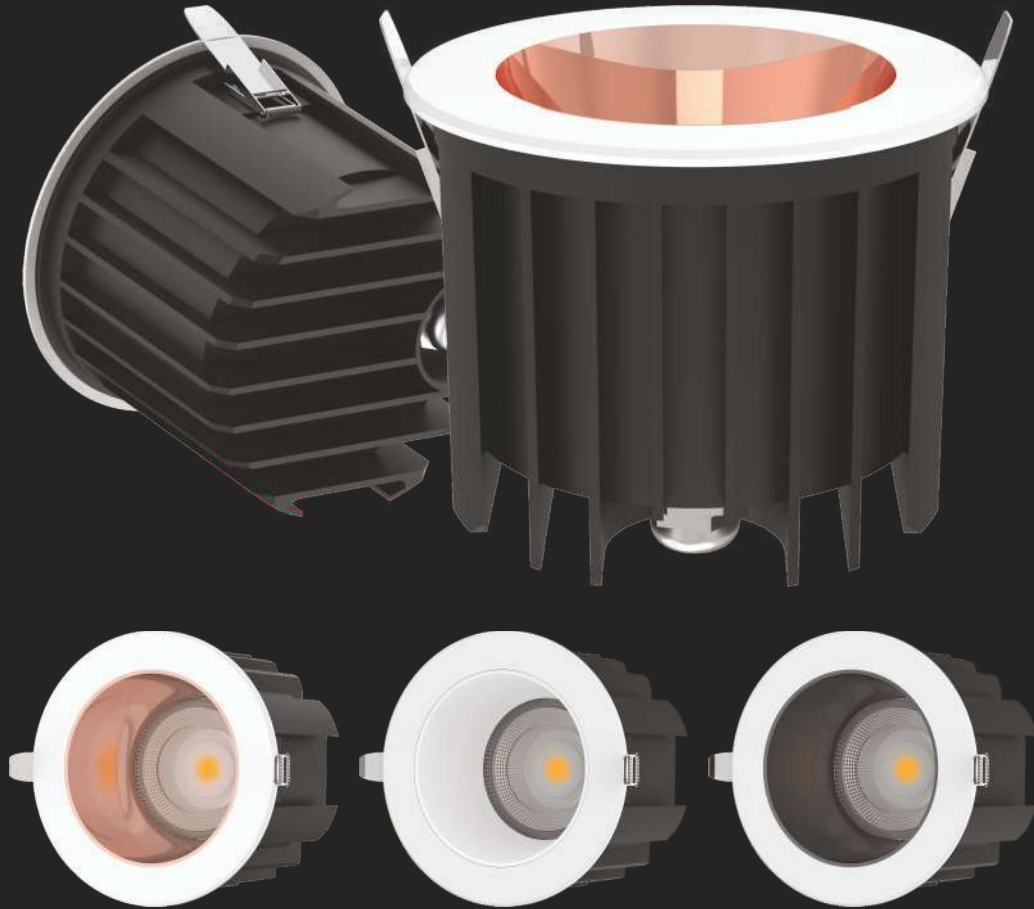

WATT	DIMENSION	CUT OUT	CCT (K)	BEAM ANGLE	CRI	MATERIAL	LED BRAND
15W	85mm x 70mm	75mm	3000k/4000k/6500k/ 3000-6500 (Tunable)	38°	80/90	Aluminum with Smooth Finish Coating	Bridgelux/Litomatic/ Cree



Anti Glare



Flicker Free



High Lumen



High CRI



Low UGR



IP54  
RATED

3500k & 5000k Available on Request



# MUSCLE

Antiglare Spotlight

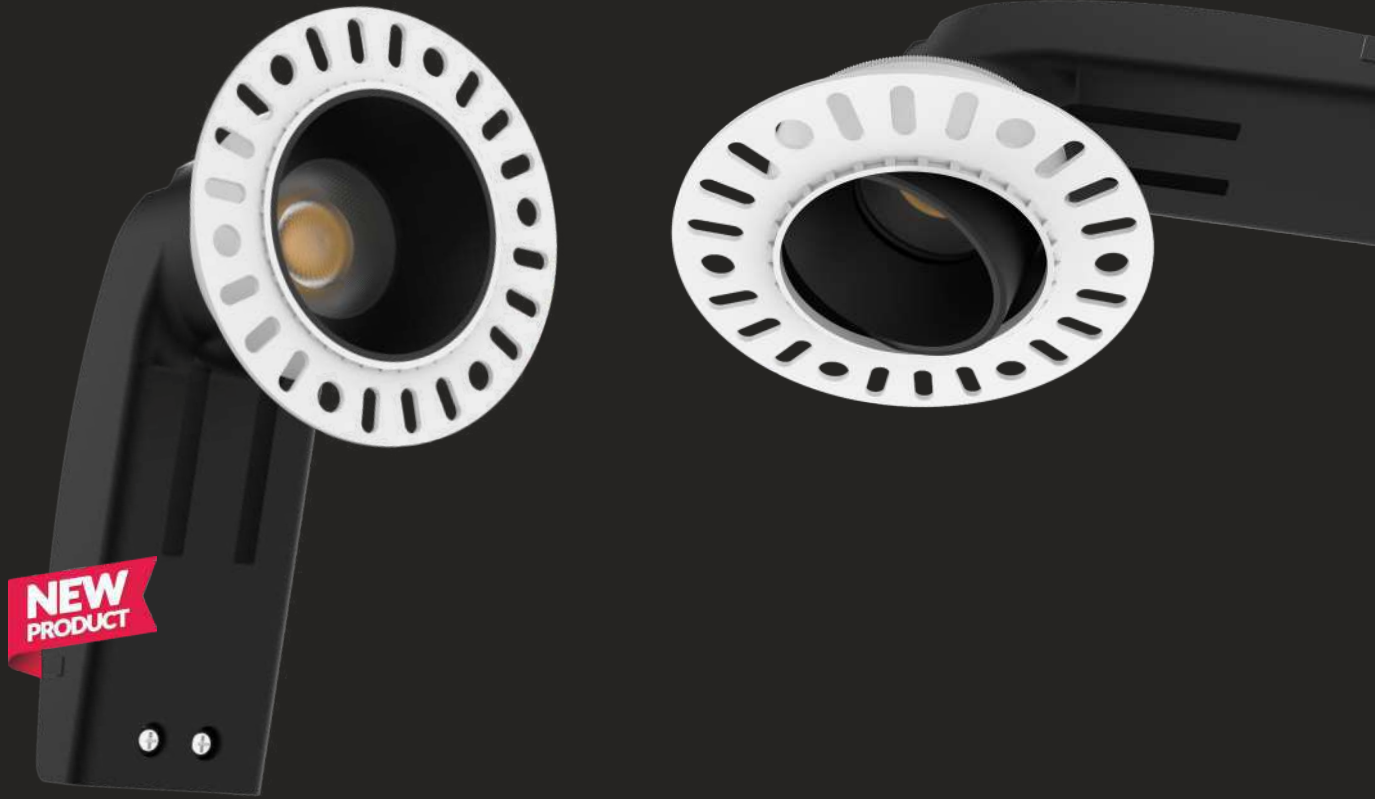

## Muscle Trimless

WATT	DIMENSION	CUT OUT	CCT (K)	BEAM ANGLE	CRI	MATERIAL	LED BRAND
12W	65mm x 60mm	44mm	3000k/4000k/6500k/ 3000-6500 (Tunable)	36°	80/90	Aluminum with Sand Finish Coating	Bridgelux/Litomatic/ Cree

## Muscle Trimless Movable

WATT	DIMENSION	CUT OUT	CCT (K)	BEAM ANGLE	CRI	MATERIAL	LED BRAND
12W	80mm x 60mm	59mm	3000k/4000k/6500k/ 3000-6500 (Tunable)	36°	80/90	Aluminum with Sand Finish Coating	Bridgelux/Litomatic/ Cree



Anti Glare



Flicker Free



High Lumen



High CRI



Low UGR



Muscle

	WATT	DIMENSION	CUT OUT	CCT (K)	BEAM ANGLE	CRI	MATERIAL	LED BRAND
	12W	54mm x 60mm	44mm	3000k/4000k/6500k/ 3000-6500 (Tunable)	36°	80/90	Aluminum with Sand Finish Coating	Bridgelux/Litomatic/ Cree

Muscle Square

	WATT	DIMENSION	CUT OUT	CCT (K)	BEAM ANGLE	CRI	MATERIAL	LED BRAND
	12W	55mmx60mm	45mm	3000k/4000k/6500k/ 3000-6500 (Tunable)	36°	80/90	Aluminum with Sand Finish Coating	Bridgelux/Litomatic/ Cree

Muscle Double

	WATT	DIMENSION	CUT OUT	CCT (K)	BEAM ANGLE	CRI	MATERIAL	LED BRAND
	2X12W	140mmx69mmx90mm	134 x58mm	3000k/4000k/6500k/ 3000-6500 (Tunable)	36°	80/90	Aluminum with Sand Finish Coating	Bridgelux/Litomatic Cree

# MIRACLE

Degree Adjustable Spotlight



WATT	DIMENSION	CUT OUT	CCT (K)	BEAM ANGLE	CRI	MATERIAL	LED BRAND
12w	80mmx62mm	75mm	3000k/4000k/6500k/ 3000-6500 (Tunable)	15°-50°Adj.	80/90	Aluminum with Sand Finish Coating	Bridgelux/Litomatic/ Cree



Anti Glare



Flicker Free



High Lumen



High CRI



Low UGR

# BEAM

## Antiglare Spotlight



WATT	DIMENSION	CUT OUT	CCT (K)	BEAM ANGLE	CRI	MATERIAL	LED BRAND
7W	76mm x 66mm	45mm	3000k/4000k/6500k/ 3000-6500 (Tunable)	15/24°	80/90	Aluminum with Sand Finish Coating	Bridgelux/Litomatic/ Cree



Anti Glare



Flicker Free



High Lumen



High CRI



Low UGR

# MARSHALL

## Movable Adjustable Spotlight



### Single

WATT	DIMENSION	CUT OUT	CCT (K)	BEAM ANGLE	CRI	MATERIAL	LED BRAND
12W	82mm x 95mm	75mm	3000k/4000k/6500k/ 3000-6500 (Tunable)	36°	80/90	Aluminum with Sand Finish Coating	Bridgelux/Litomatic/ Cree

### Double

WATT	DIMENSION	CUT OUT	CCT (K)	BEAM ANGLE	CRI	MATERIAL	LED BRAND
2 x 12W	82mm x 152mm x 95mm	75mm x 145mm	3000k/4000k/6500k/ 3000-6500 (Tunable)	36°	80/90	Aluminum with Sand Finish Coating	Bridgelux/Litomatic/ Cree



Anti Glare



Flicker Free



High Lumen



High CRI



Low UGR

# ABSOLUTE

Antiglare Downlight



WATT	DIMENSION	CUT OUT	CCT (K)	BEAM ANGLE	CRI	MATERIAL	LED BRAND
12W	88mm x 65mm	75mm	3000k/4000k/6500k/ 3000-6500 (Tunable)	90°	80/90	Aluminum with Sand Finish Coating	Bridgelux/Litomatic/ Cree
20W	110mm x 75mm	95mm	3000k/4000k/6500k/ 3000-6500 (Tunable)	90°	80/90	Aluminum with Sand Finish Coating	Bridgelux/Litomatic/ Cree
30W	136mm x 96mm	125mm	3000k/4000k/6500k/ 3000-6500 (Tunable)	90°	80/90	Aluminum with Sand Finish Coating	Bridgelux/Litomatic/ Cree
40W	160mm x 110mm	150mm	3000k/4000k/6500k/ 3000-6500 (Tunable)	90°	80/90	Aluminum with Sand Finish Coating	Bridgelux/Litomatic/ Cree



Anti Glare



Flicker Free



High Lumen



High CRI



Low UGR

# ELAN

## Laser Blade

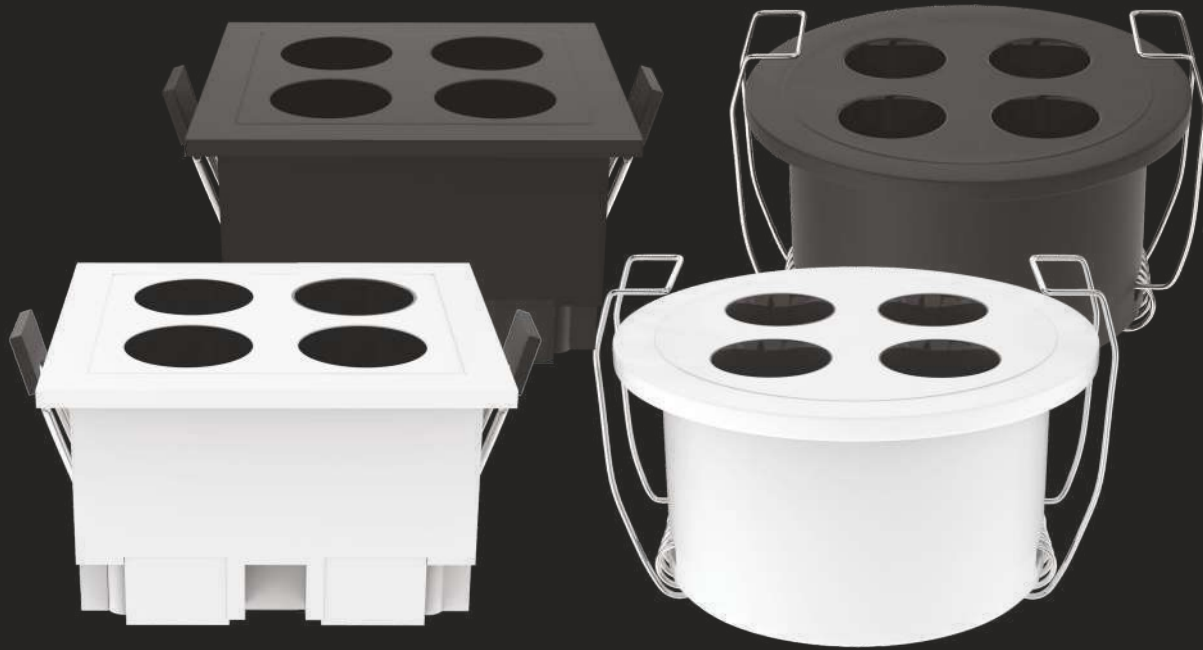

### Square

WATT	DIMENSION	CUT OUT	CCT (K)	BEAM ANGLE	CRI	MATERIAL	LED BRAND
10W	75mm x 75mm x 42mm	70 x 70mm	3000k/4000k/6500k/ 3000-6500 (Tunable)	36°	80/90	Aluminum with Sand Finish Coating	Bridgelux/Litomatic/ Cree

### Round

WATT	DIMENSION	CUT OUT	CCT (K)	BEAM ANGLE	CRI	MATERIAL	LED BRAND
10W	85mm x 38mm	75mm	3000k/4000k/6500k/ 3000-6500 (Tunable)	36°	80/90	Aluminum with Sand Finish Coating	Bridgelux/Litomatic/ Cree



Anti Glare



Flicker Free



High Lumen



High CRI



Low UGR

## Elan

	WATT	DIMENSION	CUT OUT	CCT (K)	BEAM ANGLE	CRI	MATERIAL	LED BRAND
	3W	45mm x 45mm x 42mm	42mm x 37mm	3000k/4000k/6500k/ 3000-6500 (Tunable)	36°	80/90	Aluminum with Sand Finish Coating	Bridgelux/Litomatic/ Cree

## Elan Laser Blade

	WATT	DIMENSION	CUT OUT	CCT (K)	BEAM ANGLE	CRI	MATERIAL	LED BRAND
	12W	147mm x 45mm x 42mm	142mm x 37mm	3000k/4000k/6500k/ 3000-6500 (Tunable)	36°	80/90	Aluminum with Sand Finish Coating	Bridgelux/Litomatic/ Cree

## Elan Surface Laser Blade

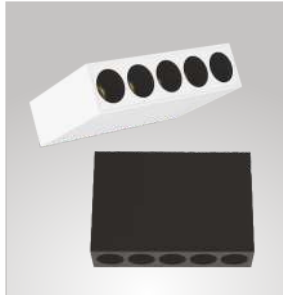
	WATT	DIMENSION	CUT OUT	CCT (K)	BEAM ANGLE	CRI	MATERIAL	LED BRAND
	12W	138mm x 36mm x 83mm	-	3000k/4000k/6500k/ 3000-6500 (Tunable)	36°	80/90	Aluminum with Sand Finish Coating	Bridgelux/Litomatic/ Cree

## Elan Surface Round

	WATT	DIMENSION	CUT OUT	CCT (K)	BEAM ANGLE	CRI	MATERIAL	LED BRAND
	10W	70mm x 83mm	-	3000k/4000k/6500k/ 3000-6500 (Tunable)	36°	80/90	Aluminum with Sand Finish Coating	Bridgelux/Litomatic/ Cree

## Elan Surface Square

	WATT	DIMENSION	CUT OUT	CCT (K)	BEAM ANGLE	CRI	MATERIAL	LED BRAND
	10W	66mm x 66mm x 83mm	-	3000k/4000k/6500k/ 3000-6500 (Tunable)	36°	80/90	Aluminum with Sand Finish Coating	Bridgelux/Litomatic/ Cree



# JOY

## Cylinder Spotlight



### Concealed

WATT	DIMENSION	CUT OUT	CCT (K)	BEAM ANGLE	CRI	MATERIAL	LED BRAND
12W	45mm x 100mm	45mm OD : 53mm	3000k/4000k/6500k/ 3000-6500 (Tunable)	36°	80/90	Aluminum with Sand Finish Coating	Bridgelux/Litomatic/ Cree

### Surface

WATT	DIMENSION	CUT OUT	CCT (K)	BEAM ANGLE	CRI	MATERIAL	LED BRAND
12W	45mm x 100mm	OD : 53mm	3000k/4000k/6500k/ 3000-6500 (Tunable)	36°	80/90	Aluminum with Sand Finish Coating	Bridgelux/Litomatic/ Cree



Anti Glare



Flicker Free



High Lumen



High CRI



Low UGR

# ESTEEM

Movable Surface Cylinder Spotlight



WATT	DIMENSION	CUT OUT	CCT (K)	BEAM ANGLE	CRI	MATERIAL	LED BRAND
12W	63mm x 160mm	-	3000k/4000k/6500k/ 3000-6500 (Tunable)	36°	80/90	Aluminum with Sand Finish Coating	Bridgelux/Litomatic/ Cree



Anti Glare



Flicker Free



High Lumen



High CRI



Low UGR

3500k & 5000k Available on Request

# BULLET

## Surface Cylinder Spotlight



WATT	DIMENSION	CUT OUT	CCT (K)	BEAM ANGLE	CRI	MATERIAL	LED BRAND
7W	45mm x 100mm	-	3000k/4000k/6500k/ 3000-6500 (Tunable)	36°	80/90	Aluminum with Sand Finish Coating	Bridgelux/Litomatic Cree
12W	54mm x 113mm	-	3000k/4000k/6500k/ 3000-6500 (Tunable)	36°	80/90	Aluminum with Sand Finish Coating	Bridgelux/Litomatic/ Cree
20W	62mm x 130mm	-	3000k/4000k/6500k/ 3000-6500 (Tunable)	36°	80/90	Aluminum with Sand Finish Coating	Bridgelux/Litomatic/ Cree



Anti Glare



Flicker Free



High Lumen



High CRI



Low UGR

# SHADE

Surface Cylinder Spotlight



WATT	DIMENSION	CUT OUT	CCT (K)	BEAM ANGLE	CRI	MATERIAL	LED BRAND
12W	78mm x 78mm x 90mm	-	3000k/4000k/6500k/ 3000-6500 (Tunable)	24°	80/90	Aluminum with Smooth Finish Coating	Bridgelux/Litomatic/ Cree
12W	78mm x 90mm	-	3000k/4000k/6500k/ 3000-6500 (Tunable)	24°	80/90	Aluminum with Smooth Finish Coating	Bridgelux/Litomatic/ Cree



Anti Glare



Flicker Free



High Lumen



High CRI



Low UGR

3500k & 5000k Available on Request

# PACE

## Movable Surface Cylinder Spotlight



WATT	DIMENSION	CUT OUT	CCT (K)	BEAM ANGLE	CRI	MATERIAL	LED BRAND
12W	78mm x 110mm	-	3000k/4000k/6500k/ 3000-6500 (Tunable)	36°	80/90	Aluminum with Sand Finish Coating	Bridgelux/Litomatic/ Cree
12W	80mm X 80mm X 110mm	-	3000k/4000k/6500k/ 3000-6500 (Tunable)	36°	80/90	Aluminum with Sand Finish Coating	Bridgelux/Litomatic/ Cree



Anti Glare



Flicker Free



High Lumen



High CRI



Low UGR

# HOPE

Mini Spotlight



WATT	DIMENSION	CUT OUT	CCT (K)	BEAM ANGLE	CRI	MATERIAL	LED BRAND
3w	72mmx20mm	17mm	3000k/4000k	15°/24°	80/90	Aluminum with Sand Finish Coating	Cree/Goldi/Bridgelux



Anti Glare



Flicker Free



High Lumen



High CRI



Low UGR

3500k & 5000k Available on Request

# MARVELL

## Tracklight



WATT	DIMENSION	CUT OUT	CCT (K)	BEAM ANGLE	CRI	MATERIAL	LED BRAND
12W	215mm x 58mm	-	3000k/4000k/6500k/ 3000-6500 (Tunable)	Adjustable	80/90	Aluminum with Sand Finish Coating	Bridgelux/Litomatic/ Cree
20W	244mm x 74mm	-	3000k/4000k/6500k/ 3000-6500 (Tunable)	Adjustable	80/90	Aluminum with Sand Finish Coating	Bridgelux/Litomatic/ Cree



Anti Glare



Flicker Free



High Lumen



High CRI



Low UGR

# VELLAR

## Tracklight



WATT	DIMENSION	CUT OUT	CCT (K)	BEAM ANGLE	CRI	MATERIAL	LED BRAND
30W	185mm x 145mm x 74mm	-	3000k/4000k/6500k/ 3000-6500 (Tunable)	15°/24°/36°	80/90	Aluminum with Sand Finish Coating	Cree/Goldi/Bridgelux
40W	192mm X 150mm X 90mm	-	3000k/4000k/6500k/ 3000-6500 (Tunable)	15°/24°/36°	80/90	Aluminum with Sand Finish Coating	Cree/Goldi/Bridgelux



Anti Glare



Flicker Free



High Lumen



High CRI



Low UGR



# ADORE

Laser Blade



Anti Glare



Flicker Free



High Lumen



High CRI



Low UGR

3500k & 5000k Available on Request

### Adore Laser

	WATT	DIMENSION	CUT OUT	CCT (K)	BEAM ANGLE	CRI	MATERIAL	LED BRAND
	8W	80mm x 35mm	74mm	3000k/4000k/6500k/ 3000-6500 (Tunable)	34°	80/90	Aluminum with Smooth Finish Coating	Bridgelux/Litomatic/ Cree
	15W	128mm x 36mm	120mm	3000k/4000k/6500k/ 3000-6500 (Tunable)	34°	80/90	Aluminum with Smooth Finish Coating	Bridgelux/Litomatic/ Cree
	20W	175mm x 36mm	165mm	3000k/4000k/6500k/ 3000-6500 (Tunable)	34°	80/90	Aluminum with Smooth Finish Coating	Bridgelux/Litomatic Cree

### Adore Laser Trimless

	WATT	DIMENSION	CUT OUT	CCT (K)	BEAM ANGLE	CRI	MATERIAL	LED BRAND
	8W	71mm x 35mm	-	3000k/4000k/6500k/ 3000-6500 (Tunable)	34°	80/90	Aluminum with Smooth Finish Coating	Bridgelux/Litomatic/ Cree
	15W	115mm x 35mm	-	3000k/4000k/6500k/ 3000-6500 (Tunable)	34°	80/90	Aluminum with Smooth Finish Coating	Bridgelux/Litomatic/ Cree

### Adore Spotlight

	WATT	DIMENSION	CUT OUT	CCT (K)	BEAM ANGLE	CRI	MATERIAL	LED BRAND
	7W	70mm x 58mm	-	3000k/4000k/6500k/ 3000-6500 (Tunable)	24°	80/90	Aluminum with Smooth Finish Coating	Bridgelux/Litomatic/ Cree
	12W	116mm x 76mm	-	3000k/4000k/6500k/ 3000-6500 (Tunable)	24°	80/90	Aluminum with Smooth Finish Coating	Bridgelux/Litomatic/ Cree

### Adore Downlight

	WATT	DIMENSION	CUT OUT	CCT (K)	BEAM ANGLE	CRI	MATERIAL	LED BRAND
	6W	70mm x 56mm	-	3000k/4000k/6500k/ 3000-6500 (Tunable)	100°	80/90	Aluminum with Smooth Finish Coating	Bridgelux/Litomatic/ Cree
	12W	115mm x 78mm	-	3000k/4000k/6500k/ 3000-6500 (Tunable)	100°	80/90	Aluminum with Smooth Finish Coating	Bridgelux/Litomatic/ Cree

### Adore Track light

	WATT	DIMENSION	CUT OUT	CCT (K)	BEAM ANGLE	CRI	MATERIAL	LED BRAND
	3W	71mm x 70mm	-	3000k/4000k/6500k/ 3000-6500 (Tunable)	24°	80/90	Aluminum with Smooth Finish Coating	Bridgelux/Litomatic/ Cree
	7W	116mm x 100mm	-	3000k/4000k/6500k/ 3000-6500 (Tunable)	24°	80/9000	Aluminum with Smooth Finish Coating	Bridgelux/Litomatic/ Cree

# REMOTE

Multifunctional Remote Controller



# SCENE

Scene Mode Controller



# OUR CLIENTS





Illuminating Lives Inspiring Legacies



**Select**

**Litomatic (TECH.) Pvt. Ltd.**

**Head Office**

Plot No. : E1-228, RIICO Industrial Area,  
Opp. Urban Square Mall, Sukher, Udaipur - 313001 (Raj.)

[info@litomatic.com](mailto:info@litomatic.com)

[www.litomatic.com](http://www.litomatic.com)