



**LED Lum**

Lighting. Simplified

**INDOOR  
CATALOG**

**2024**

[www.ledlumlighting.com](http://www.ledlumlighting.com)





**PAGE**  
004



**PAGE**  
004



**PAGE**  
004



**PAGE**  
004



**PAGE**  
005



**PAGE**  
005

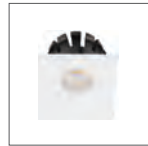

**PAGE**  
005



**PAGE**  
005



**PAGE**  
006



**PAGE**  
006



**PAGE**  
007



**PAGE**  
007



**PAGE**  
007



**PAGE**  
007



**PAGE**  
008



**PAGE**  
010



**PAGE**  
012



**PAGE**  
014



**PAGE**  
014



**PAGE**  
014



**PAGE**  
014



**PAGE**  
014



**PAGE**  
016



**PAGE**  
018



**PAGE**  
018



**PAGE**  
018



**PAGE**  
020



**PAGE**  
022



**PAGE**  
024



**PAGE**  
026



**PAGE**  
028



**PAGE**  
030



**PAGE**  
030



**PAGE**  
030



**PAGE**  
032



**PAGE**  
033



**PAGE**  
033



**PAGE**  
034



**PAGE**  
036



**PAGE**  
036



**PAGE**  
036



**PAGE**  
036



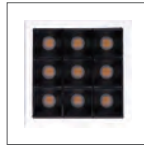

**PAGE**  
036

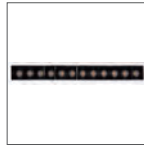

**PAGE**  
036



**PAGE**  
037



**PAGE**  
038



**PAGE**  
040



**PAGE**  
042



**PAGE**  
044



**PAGE**  
044



**PAGE**  
044



**PAGE**  
046



**PAGE**  
046



**PAGE**  
048



**PAGE**  
050



**PAGE**  
050



**PAGE**  
050



**PAGE**  
053



**PAGE**  
053



**PAGE**  
054



**PAGE**  
054



**PAGE**  
054



**PAGE**  
054



**PAGE**  
054



**PAGE**  
055



**PAGE**  
056



**PAGE**  
057



**PAGE**  
058



**PAGE**  
059



**PAGE**  
060



**PAGE**  
061



**PAGE**  
062



**PAGE**  
063



**PAGE**  
064



**PAGE**  
066



**PAGE**  
066



**PAGE**  
068



**PAGE**  
070



**PAGE**  
072



**PAGE**  
072



**PAGE**  
072



**PAGE**  
072



**PAGE**  
072



**PAGE**  
074



PAGE  
076



PAGE  
078



PAGE  
080



PAGE  
080



PAGE  
080



PAGE  
081



PAGE  
081



PAGE  
081



PAGE  
081



PAGE  
081



PAGE  
084



PAGE  
085



PAGE  
085



PAGE  
085



PAGE  
085



PAGE  
085



PAGE  
086



PAGE  
086



PAGE  
086



PAGE  
086



PAGE  
090



PAGE  
092



PAGE  
092



PAGE  
093



PAGE  
093



PAGE  
094



PAGE  
096



PAGE  
098



PAGE  
098



PAGE  
099



PAGE  
099



PAGE  
099



PAGE  
099



PAGE  
100



PAGE  
102



PAGE  
102



PAGE  
102



PAGE  
102



PAGE  
102



PAGE  
102



PAGE  
103



PAGE  
103



PAGE  
103



PAGE  
103



PAGE  
104



PAGE  
104



PAGE  
104



PAGE  
107



PAGE  
108



PAGE  
109



PAGE  
110



PAGE  
111



PAGE  
112



PAGE  
113



PAGE  
114



PAGE  
115



PAGE  
116



PAGE  
118



PAGE  
119



PAGE  
119



PAGE  
120



PAGE  
120



PAGE  
123



PAGE  
123



PAGE  
123



PAGE  
123



PAGE  
123



PAGE  
124



PAGE  
124



PAGE  
124



PAGE  
124



PAGE  
124



PAGE  
124



PAGE  
124



PAGE  
124



PAGE  
124



PAGE  
124



PAGE  
126



PAGE  
127



PAGE  
128



PAGE  
128



PAGE  
128



PAGE  
128



PAGE  
129





**PAGE**  
130



**PAGE**  
130



**PAGE**  
132



**PAGE**  
132



**PAGE**  
132



**PAGE**  
132



**PAGE**  
132



**PAGE**  
132



**PAGE**  
132



**PAGE**  
132



**PAGE**  
135



**PAGE**  
136



**PAGE**  
137

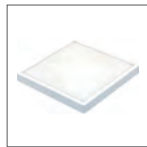

**PAGE**  
138



**PAGE**  
139



**PAGE**  
140



**PAGE**  
142



**PAGE**  
142



**PAGE**  
145



**PAGE**  
146



**PAGE**  
147

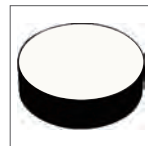

**PAGE**  
148



**PAGE**  
149

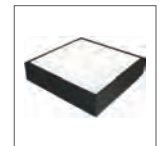

**PAGE**  
150



**PAGE**  
152



**PAGE**  
152



**PAGE**  
152



**PAGE**  
152

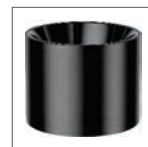

**PAGE**  
154



**PAGE**  
156



**PAGE**  
158



**PAGE**  
159



**PAGE**  
160



**PAGE**  
161



**PAGE**  
162



**PAGE**  
163



**PAGE**  
163



**PAGE**  
164



**PAGE**  
164



**PAGE**  
165



**PAGE**  
165



**PAGE**  
165



**PAGE**  
166



**PAGE**  
166

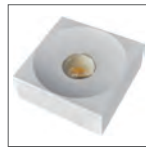

**PAGE**  
167



**PAGE**  
167



**PAGE**  
168



**PAGE**  
168



**PAGE**  
169

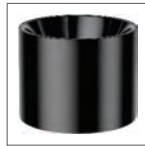

**PAGE**  
170



**PAGE**  
172



**PAGE**  
172



**PAGE**  
172



**PAGE**  
172



**PAGE**  
172



**PAGE**  
172



**PAGE**  
174



**PAGE**  
176



**PAGE**  
179



**PAGE**  
179



**PAGE**  
179



**PAGE**  
179



**PAGE**  
180



**PAGE**  
180



**PAGE**  
181



**PAGE**  
181

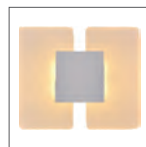

**PAGE**  
182

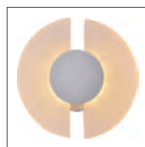

**PAGE**  
182



**PAGE**  
183



**PAGE**  
183



**PAGE**  
183



**PAGE**  
184



**PAGE**  
184



**PAGE**  
185



**PAGE**  
185



**PAGE**  
186



**PAGE**  
186



**PAGE**  
187



**PAGE**  
188



**PAGE**  
188



**PAGE**  
188



**PAGE**  
189



**PAGE**  
189



**PAGE**  
189



**PAGE**  
190



**PAGE**  
191

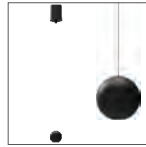

**PAGE**  
192



**PAGE**  
193



**PAGE**  
194



**PAGE**  
196



**PAGE**  
196



**PAGE**  
197



**PAGE**  
197



**PAGE**  
197



**PAGE**  
197



**PAGE**  
197



**PAGE**  
198



**PAGE**  
198



**PAGE**  
198



**PAGE**  
198



**PAGE**  
200



**PAGE**  
201



**PAGE**  
202



**PAGE**  
203



**PAGE**  
203



**PAGE**  
204



**PAGE**  
206



**PAGE**  
206



**PAGE**  
210



**PAGE**  
210



**PAGE**  
212



**PAGE**  
212



**PAGE**  
212



**PAGE**  
213

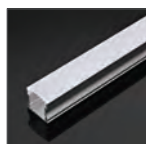

**PAGE**  
213

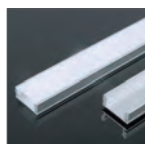

**PAGE**  
213

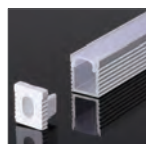

**PAGE**  
213



**PAGE**  
214

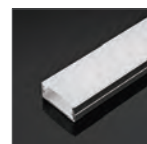

**PAGE**  
214

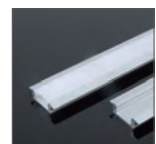

**PAGE**  
214



**PAGE**  
214

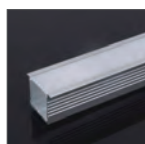

**PAGE**  
215

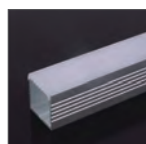

**PAGE**  
215



**PAGE**  
215



**PAGE**  
215



**PAGE**  
215





**PAGE**  
215

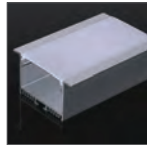

**PAGE**  
216

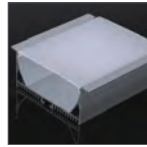

**PAGE**  
216

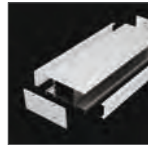

**PAGE**  
216



**PAGE**  
216



**PAGE**  
216



**PAGE**  
216



**PAGE**  
218



**PAGE**  
218



**PAGE**  
218



**PAGE**  
218



**PAGE**  
222



**PAGE**  
224



**PAGE**  
226



**PAGE**  
228



**PAGE**  
229



**PAGE**  
230



**PAGE**  
231



**PAGE**  
232



**PAGE**  
233



**PAGE**  
234



**PAGE**  
234



**PAGE**  
234

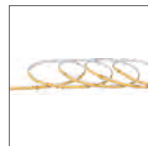

**PAGE**  
234



**PAGE**  
235



**PAGE**  
236



**PAGE**  
237



**PAGE**  
239



**PAGE**  
241



**PAGE**  
242



**PAGE**  
243



**PAGE**  
244



**PAGE**  
244



**PAGE**  
244



**PAGE**  
244



**PAGE**  
246



**PAGE**  
246



**PAGE**  
246



**PAGE**  
246



**PAGE**  
246



**PAGE**  
246



**PAGE**  
246



**PAGE**  
246



**PAGE**  
246



**PAGE**  
247



**PAGE**  
247



**PAGE**  
247



**PAGE**  
247



**PAGE**  
247



**PAGE**  
248



**PAGE**  
249



**PAGE**  
249



**PAGE**  
249



**PAGE**  
250



**PAGE**  
250



**PAGE**  
250



**PAGE**  
250



**PAGE**  
251



**PAGE**  
255



**PAGE**  
255



**PAGE**  
255



**PAGE**  
255



**PAGE**  
256



**PAGE**  
257



**PAGE**  
257



**PAGE**  
257



**PAGE**  
258



**PAGE**  
259



**PAGE**  
259



**PAGE**  
259



**PAGE**  
260



**PAGE**  
260



**PAGE**  
260



**PAGE**  
261



**PAGE**  
261



**PAGE**  
261



**PAGE**  
261



**PAGE**  
262



**PAGE**  
262



**PAGE**  
263



**PAGE**  
264



**PAGE**  
265



**PAGE**  
265



**PAGE**  
266



**PAGE**  
266



**PAGE**  
267



**PAGE**  
268

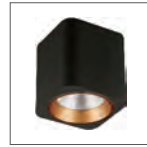

**PAGE**  
268



**PAGE**  
268



**PAGE**  
268



**PAGE**  
269



**PAGE**  
269



**PAGE**  
269



**PAGE**  
270

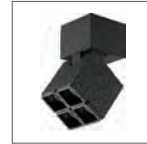

**PAGE**  
270



**PAGE**  
270



**PAGE**  
271



**PAGE**  
271



**PAGE**  
271



**PAGE**  
272



**PAGE**  
273



**PAGE**  
274



**PAGE**  
274



**PAGE**  
274





**INDOOR  
LED LIGHTING**

---

DOWN LIGHT COB SERIES



## APPLICATION OF LED DOWN LIGHT

LED down light is a kind of embedded in the ceiling under the beam of light-type lighting, will not Because the lamp set and destruction of the perfect unity of the ceiling art. The most important feature is the ability to maintain Architectural decoration of the overall unity and perfection, with structural advantages is the use of light to hide architectural decorationInternal, LED light source is not exposed, does not stimulate the eye skin.

In general, the user is most concerned about whether the LED down light to light up our hopeHope it brightens the place, whether it makes us feel comfortable; however, for professional lighting design Division, in addition to familiar with a variety of LED down lamp body selection, lens and reflective system, But also must be based on the light distribution curve of light to know LED spotlight projection lamp quality, total Calculate the efficiency of LED ceiling light and any point of space Illumination value, this can also calculate the space The distribution of Illumination within the region.

LED down spotlights for hotels, shopping malls, restaurants, home, railway stations, museums and so on Large area or local lighting places,



————— LED DOWN LIGHT COB SERIES —————



**CAN BE MADE TO ORDER**

DIMMABLE/TUNABLE WITH RF CONTROL

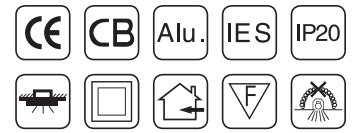

LLF063



LLF073



LLF075



LLF074

**PRODUCT PARAMETERS**



Model No.	Power	LED Chip	CRI	Lumens	CCT	Body Color	Beam Angle
LLF063	5W	BRIDGELUX COB	≥80	80lm/W	3000K/4000K	white	24°
LLF073	9W	BRIDGELUX COB	≥80	80lm/W	3000K/4000K/6000K	white	24°
LLF074	16W	BRIDGELUX COB	≥80	80lm/W	3000K/4000K/6000K	white	24°
LLF075	30W	BRIDGELUX COB	≥80	80lm/W	3000K/4000K/6000K	white	24°

**PRODUCT DIMENSION**

Unit (mm)

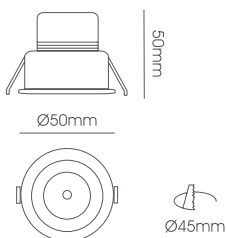

**LLF063-5W**  
Body Size: Ø50x50mm  
Cut-Size: Ø45mm

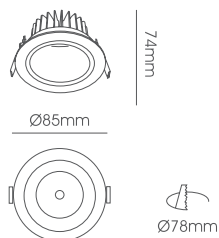

**LLF073-9W**  
Body Size: Ø85\*74mm  
Cut-Size: Ø78mm

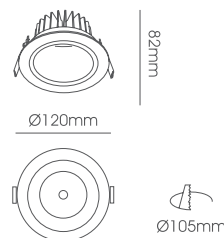

**LLF074-16W**  
Body Size: Ø120\*82mm  
Cut-Size: Ø105mm

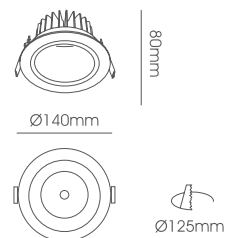

**LLF075-30W**  
Body Size: Ø140\*80mm  
Cut-Size: Ø125mm

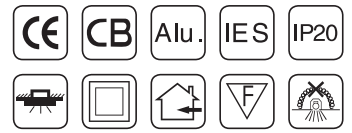

**PRODUCT PARAMETERS**



Model No.	Power	LED Chip	CRI	Lumens	CCT	Body Color	Beam Angle
LLF086	3W	BRIDGELUX COB	≥80	80lm/W	3000K/4000K	White / Black	60°
LLF087	3W	BRIDGELUX COB	≥80	80lm/W	3000K/4000K	White	60°
LLF088	3W	BRIDGELUX COB	≥80	80lm/W	3000K/4000K	White	60°
LLF089	3W	BRIDGELUX COB	≥80	80lm/W	3000K/4000K	White / Black	60°

**PRODUCT DIMENSION**

Unit (mm)

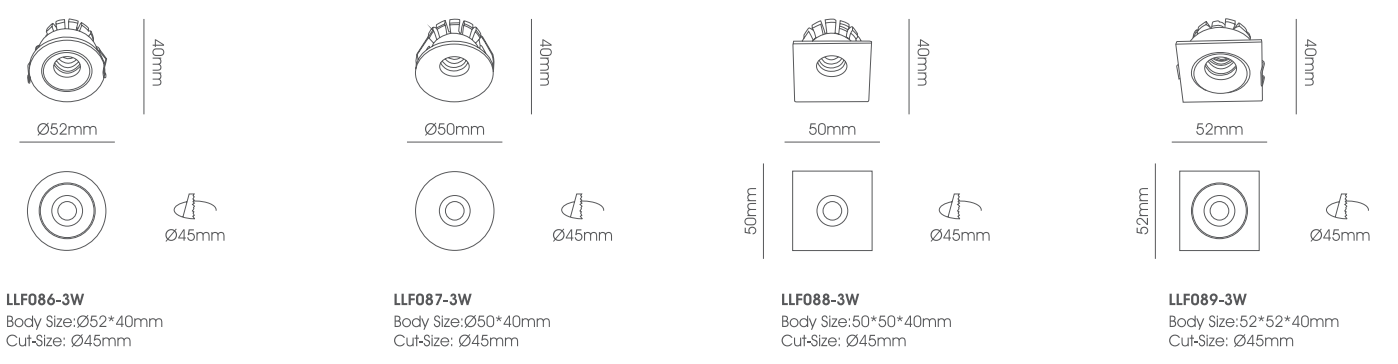



LLF093



LLF093A

PRODUCT PARAMETERS

DOB LED | CREE

Model No.	Power	LED Chip	CRI	Lumens	CCT	Body Color	Beam Angle
LLF093	1W	DOB LED	≥80	90-100Lm	3000K/4000K	White / Black	30°
LLF093A	1W	CREE	≥80	90-100Lm	3000K/4000K	White / Black	30°

PRODUCT DIMENSION

Unit(mm)

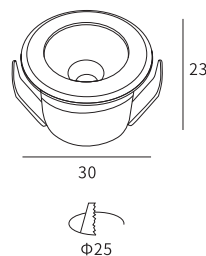

**LLF093-1W**  
Body Size : 30\*H23mm  
Cut-Size : Ø25

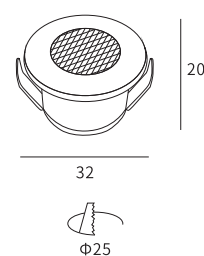

**LLF093A-1W**  
Body Size : 32\*H20mm  
Cut-Size : Ø25

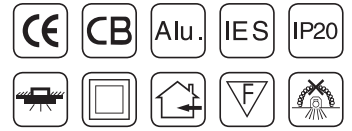

LLF100A

LLF100C



LLF100B

LLF100D

**PRODUCT PARAMETERS**



Model No.	Power	LED Chip	CRI	Lumens	CCT	Body Color	Beam Angle
LLF100A	5W	CREE COB	≥80	80lm/W	3000K/4000K	White	24°
LLF100B	3W	BRIDGELUX COB	≥80	80lm/W	3000K/4000K	White	24°
LLF100C	3W	CREE COB	≥80	80lm/W	3000K/4000K	White	30°
LLF100D	3W	CREE COB	≥80	80lm/W	3000K/4000K	White	30°

**PRODUCT DIMENSION**

Unit (mm)

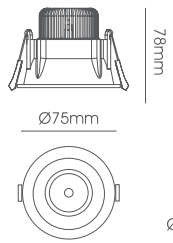

**LLF100A-5W**  
Body Size: Ø75\*78mm  
Cut-Size: Ø65mm

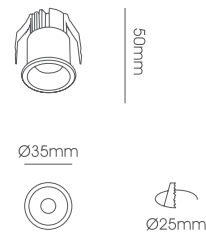

**LLF100B-3W**  
Body Size: Ø35\*50mm  
Cut-Size: Ø25mm

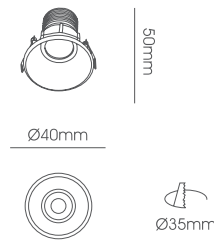

**LLF100C-3W**  
Body Size: Ø40\*50mm  
Cut-Size: Ø35mm

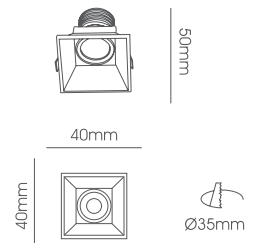

**LLF100D-3W**  
Body Size: 40\*40\*50mm  
Cut-Size: Ø35mm



PRODUCT PARAMETERS

EPISTAR

Model No.	Power	LED Chip	CRI	Lumens	CCT	Body Color	Beam Angle
LLF076	3W	EPISTAR COB	≥80	240Lm	3000K/4000K/6000K	White	120°
LLF077	6W	EPISTAR COB	≥80	480Lm	3000K/4000K/6000K	White	120°
LLF078	12W	EPISTAR COB	≥80	960Lm	3000K/4000K/6000K	White	120°
LLF079	18W	EPISTAR COB	≥80	1440Lm	3000K/4000K/6000K	White	120°

PRODUCT DIMENSION

Unit (mm)

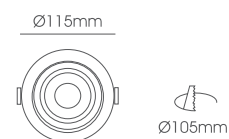
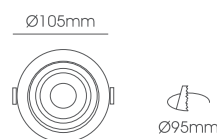
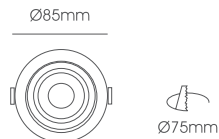
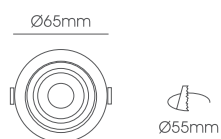

**LLF076-3W**  
Body Size: Ø65\*20mm  
Cut-Size: Ø55mm

**LLF077-6W**  
Body Size: Ø85\*20mm  
Cut-Size: Ø75mm

**LLF078-12W**  
Body Size: Ø105\*24mm  
Cut-Size: Ø95mm

**LLF079-18W**  
Body Size: Ø115\*33mm  
Cut-Size: Ø105mm



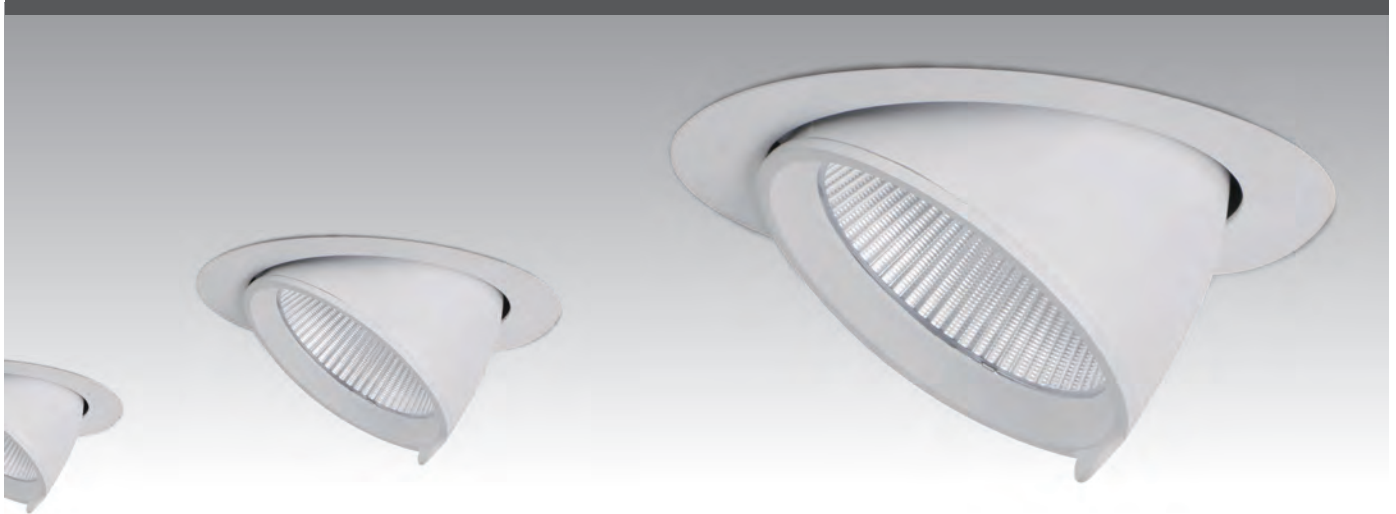

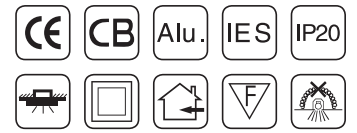

PRODUCT PARAMETERS



Model No.	Power	LED Chip	CRI	Lumens	CCT	Body Color	Beam Angle
LLF103	12W	BRIDGELUX COB	≥80	900-1020Lm	3000K/4000K/6000K	White	24°
LLF104	20W	BRIDGELUX COB	≥80	1500-1700Lm	3000K/4000K/6000K	White	24°
LLF105	30W	BRIDGELUX COB	≥80	2250-2550Lm	3000K/4000K/6000K	White	24°
LLF106	40W	BRIDGELUX COB	≥80	3000-3400Lm	3000K/4000K/6000K	White	24°

PRODUCT DIMENSION

Unit (mm)

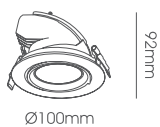

**LLF103-12W**  
Body Size: Ø100\*92mm  
Cut-Size: Ø90mm

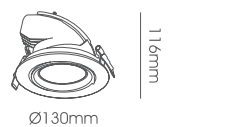

**LLF104-20W**  
Body Size: Ø130\*116mm  
Cut-Size: Ø120mm

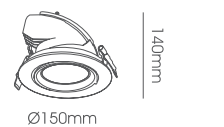

**LLF105-30W**  
Body Size: Ø150\*140mm  
Cut-Size: Ø140mm

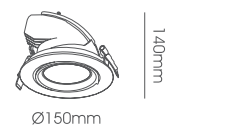

**LLF106-40W**  
Body Size: Ø150\*140mm  
Cut-Size: Ø140mm

# SELECTIVE COLOR



**CAN BE MADE TO ORDER**  
DIMMABLE/TUNABLE WITH RF CONTROL

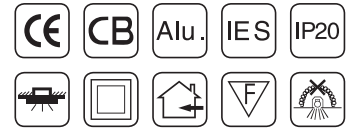

**PRODUCT PARAMETERS**

**EPISTAR**

Model No.	Power	LED Chip	CRI	Lumens	CCT	Body Color	Beam Angle
LLF110	9W	EPISTAR COB	≥80	80Lm/W	3000K/4000K	Black / White-Gold reflectoer	30°
LLF111	15W	EPISTAR COB	≥80	80Lm/W	3000K/4000K	Black / White-Gold reflectoer	30°
LLF112	3W	EPISTAR COB	≥80	80Lm/W	3000K/4000K	Black / White-Gold reflectoer	30°

**PRODUCT DIMENSION**

Unit (mm)

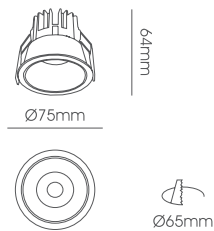

**LLF110-9W**  
Body Size: Ø75\*64mm  
Cut-Size: Ø65mm

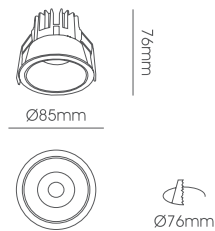

**LLF111-15W**  
Body Size: Ø85\*76mm  
Cut-Size: Ø76mm

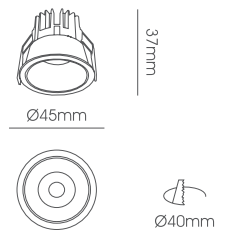

**LLF112-3W**  
Body Size: Ø45\*37mm  
Cut-Size: Ø40mm







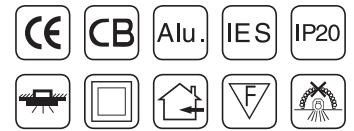

PRODUCT PARAMETERS



Model No.	Power	LED Chip	CRI	Lumens	CCT	Body Color	Beam Angle
LLF113	3W	CREE XPE	≥80	240Lm	3000K/4000K	White	45°
LLF114	2.5W*2	CREE XPE	≥80	400Lm	3000K/4000K	White	45°
LLF115	2.5W*3	CREE XPE	≥80	600Lm	3000K/4000K	White	45°
LLF116	2.5W*5	CREE XPE	≥80	1000Lm	3000K/4000K	White	45°
LLF117	2.5W*10	CREE XPE	≥80	2000Lm	3000K/4000K	White	45°

PRODUCT DIMENSION

Unit (mm)

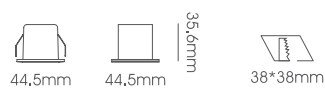

**LLF113-3W**  
Body Size: 44.5\*44.5\*35.6mm  
Cut-Size: 38\*38mm



**LLF114-2.5W\*2**  
Body Size: 74.5\*44.5\*35.6mm  
Cut-Size: 68\*38mm



**LLF115-2.5W\*3**  
Body Size: 104.5\*44.5\*35.6mm  
Cut-Size: 98\*38mm

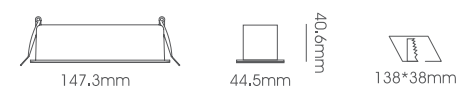

**LLF116-2.5W\*5**  
Body Size: 147.3\*44.5\*40.6mm  
Cut-Size: 138\*38mm

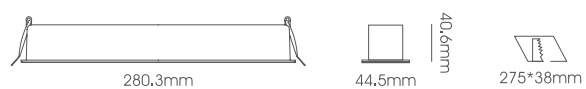

**LLF117-2.5W\*10**  
Body Size: 280.3\*44.5\*40.6mm  
Cut-Size: 275\*38mm



**CAN BE MADE TO ORDER**  
DIMMABLE/TUNABLE WITH RF CONTROL



LLF122



LLF123



LLF124

**PRODUCT PARAMETERS**



Model No.	Power	LED Chip	CRI	Lumens	CCT	Body Color	Beam Angle
LLF122	10W	CREE COB	≥80	80lm/W	3000K/4000K	White	24°
LLF123	15W	CREE COB	≥80	80lm/W	3000K/4000K	White	24°
LLF124	20W	CREE COB	≥80	80lm/W	3000K/4000K	White	24°

**PRODUCT DIMENSION**

Unit (mm)

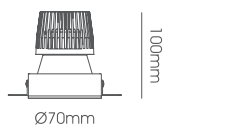

**LLF122-10W**  
Body Size: Ø70\*100mm  
Cut-Size: Ø70mm

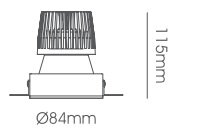

**LLF123-15W**  
Body Size: Ø84\*115mm  
Cut-Size: Ø84mm

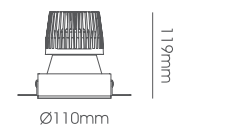

**LLF124-20W**  
Body Size: Ø110\*119mm  
Cut-Size: Ø110mm



# LED DOWN LIGHT COB SERIES



**CAN BE MADE TO ORDER**  
DIMMABLE/TUNABLE WITH RF CONTROL

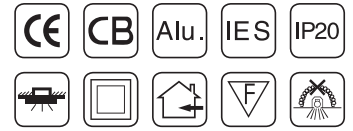

**PRODUCT PARAMETERS**



Model No.	Power	LED Chip	CRI	Lumens	CCT	Body Color	Beam Angle
LLF125	12W	CREE COB	≥80	100lm/W	3000K/4000K	White	24°
LLF126	7W	BRIDGELUX COB	≥80	80lm/W	3000K/4000K	White	24°
LLF126A	7W	BRIDGELUX COB	≥80	80lm/W	3000K/4000K	White	24°

**PRODUCT DIMENSION**

Unit (mm)



**LLF125-12W**  
Body Size: Ø105\*120mm  
Cut-Size: Ø95mm

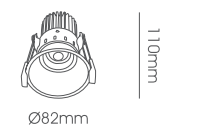

**LLF126-7W**  
Body Size: Ø82\*110mm  
Cut-Size: Ø75mm

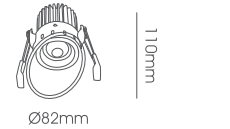

**LLF126A-7W**  
Body Size: Ø82\*110mm  
Cut-Size: Ø75mm





## LED DOWN LIGHT COB SERIES

**CAN BE MADE TO ORDER**  
DIMMABLE/TUNABLE WITH RF CONTROL



**PRODUCT PARAMETERS**



Model No.	Power	LED Chip	CRI	Lumens	CCT	Body Color	Beam Angle
LLF133	5W	BRIDGELUX COB	≥80	80Lm/W	3000K/4000K/6000K	White	38°
LLF133A	12W	BRIDGELUX COB	≥80	80Lm/W	3000K/4000K/6000K	White	38°
LLF133B	20W	BRIDGELUX COB	≥80	80Lm/W	3000K/4000K/6000K	White	38°
LLF133C	30W	BRIDGELUX COB	≥80	80Lm/W	3000K/4000K/6000K	White	38°
LLF133D	3W	BRIDGELUX COB	≥80	80Lm/W	3000K/4000K/6000K	White	38°

**PRODUCT DIMENSION**

Unit (mm)

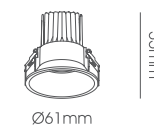
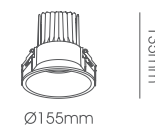
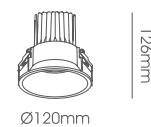
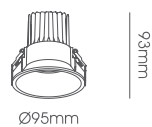
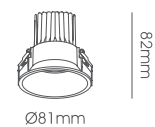

**LLF133-5W**  
Body Size: Ø81\*82mm  
Cut-Size: Ø75mm

**LLF133A-12W**  
Body Size: Ø95\*93mm  
Cut-Size: Ø85mm

**LLF133B-20W**  
Body Size: Ø120\*126mm  
Cut-Size: Ø110mm

**LLF133C-30W**  
Body Size: Ø155\*135mm  
Cut-Size: Ø149mm

**LLF133D-3W**  
Body Size: Ø61\*55mm  
Cut-Size: Ø55mm



**CAN BE MADE TO ORDER**  
DIMMABLE/TUNABLE WITH RF CONTROL

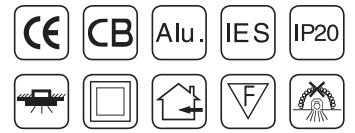

**PRODUCT PARAMETERS**



Model No.	Power	LED Chip	CRI	Lumens	CCT	Body Color	Beam Angle
LLF134	10W	BRIDGELUX COB	≥90	800-900Lm	3000K/4000K/6000K	White	38°
LLF134A	15W	BRIDGELUX COB	≥90	1200-1350Lm	3000K/4000K/6000K	White	38°
LLF134B	24W	BRIDGELUX COB	≥90	1920-2160Lm	3000K/4000K/6000K	White	38°
LLF134C	36W	BRIDGELUX COB	≥90	2880-3240Lm	3000K/4000K/6000K	White	38°

**PRODUCT DIMENSION**

Unit (mm)

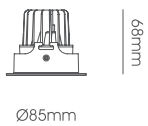

**LLF134-10W**  
Body Size: Ø85\*68mm  
Cut-Size: Ø75mm

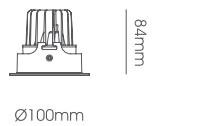

**LLF134A-15W**  
Body Size: Ø100\*84mm  
Cut-Size: Ø85mm

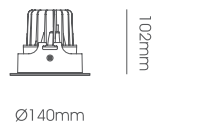

**LLF134B-24W**  
Body Size: Ø140\*102mm  
Cut-Size: Ø125mm

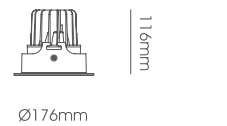

**LLF134C-36W**  
Body Size: Ø176\*116mm  
Cut-Size: Ø150mm





## **LED DOWN LIGHT** COB SERIES



**CAN BE MADE TO ORDER**  
DIMMABLE/TUNABLE WITH RF CONTROL

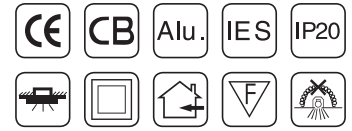

**PRODUCT PARAMETERS**

**EPISTAR**

Model No.	Power	LED Chip	CRI	Lumens	CCT	Body Color	Beam Angle
LLF136	3W	EPISTAR COB	≥80	80Lm/W	3000K/4000K/6000K	White	38°
LLF136A	6W	EPISTAR COB	≥80	80Lm/W	3000K/4000K/6000K	White	38°
LLF136B	9W	EPISTAR COB	≥80	80Lm/W	3000K/4000K/6000K	White	38°
LLF136C	16W	EPISTAR COB	≥80	80Lm/W	3000K/4000K/6000K	White	38°
LLF136D	24W	EPISTAR COB	≥80	80Lm/W	3000K/4000K/6000K	White	38°
LLF136E	30W	EPISTAR COB	≥80	80Lm/W	3000K/4000K/6000K	White	38°
LLF136F	40W	EPISTAR COB	≥80	80Lm/W	3000K/4000K/6000K	White	38°

**PRODUCT DIMENSION**

Unit (mm)

<p>35mm</p> <p>Ø55mm</p> <p>Ø47mm</p> <p><b>LLF136-3W</b> Body Size: Ø55*35mm Cut-Size: Ø47mm</p>	<p>55mm</p> <p>Ø65mm</p> <p>Ø55mm</p> <p><b>LLF136A-6W</b> Body Size: Ø65*55mm Cut-Size: Ø55mm</p>	<p>60mm</p> <p>Ø75mm</p> <p>Ø65mm</p> <p><b>LLF136B-9W</b> Body Size: Ø75*60mm Cut-Size: Ø65mm</p>	<p>75mm</p> <p>Ø100mm</p> <p>Ø85mm</p> <p><b>LLF136C-16W</b> Body Size: Ø100*75mm Cut-Size: Ø85mm</p>
-----			
<p>85mm</p> <p>Ø125mm</p> <p>Ø115mm</p> <p><b>LLF136D-24W</b> Body Size: Ø125*85mm Cut-Size: Ø115mm</p>	<p>85mm</p> <p>Ø125mm</p> <p>Ø115mm</p> <p><b>LLF136E-30W</b> Body Size: Ø125*85mm Cut-Size: Ø115mm</p>	<p>100mm</p> <p>Ø145mm</p> <p>Ø135mm</p> <p><b>LLF136F-40W</b> Body Size: Ø145*100mm Cut-Size: Ø135mm</p>	



**LED Lum**  
Lighting.Simplified

**CAN BE MADE TO ORDER**  
DIMMABLE/TUNABLE WITH RF CONTROL

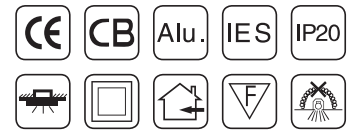

**PRODUCT PARAMETERS**

**EPISTAR**

Model No.	Power	LED Chip	CRI	Lumens	CCT	Body Color	Beam Angle
LLF127	3W	EPISTAR COB	≥80	80Lm/W	3000K/4000K/6000K	White	30°
LLF127A	6W	EPISTAR COB	≥80	80Lm/W	3000K/4000K/6000K	White	30°
LLF127B	9W	EPISTAR COB	≥80	80Lm/W	3000K/4000K/6000K	White	30°
LLF127C	16W	EPISTAR COB	≥80	80Lm/W	3000K/4000K/6000K	White	30°
LLF127D	24W	EPISTAR COB	≥80	80Lm/W	3000K/4000K/6000K	White	30°
LLF127E	30W	EPISTAR COB	≥80	80Lm/W	3000K/4000K/6000K	White	30°
LLF127F	40W	EPISTAR COB	≥80	80Lm/W	3000K/4000K/6000K	White	30°

**PRODUCT DIMENSION**

Unit (mm)

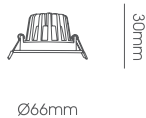

**LLF127-3W**  
Body Size: Ø66\*30mm  
Cut-Size: Ø55mm

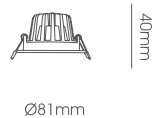

**LLF127A-6W**  
Body Size: Ø81\*40mm  
Cut-Size: Ø65mm

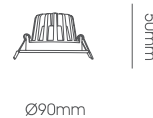

**LLF127B-9W**  
Body Size: Ø90\*50mm  
Cut-Size: Ø75mm

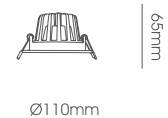

**LLF127C-16W**  
Body Size: Ø110\*65mm  
Cut-Size: Ø90mm



**LLF127D-24W**  
Body Size: Ø145\*84mm  
Cut-Size: Ø135mm



**LLF127E-30W**  
Body Size: Ø145\*84mm  
Cut-Size: Ø135mm



**LLF127F-40W**  
Body Size: Ø165\*110mm  
Cut-Size: Ø150mm



bridgelux

SPARE REFLECTOR AVAILABLE



Chrome Plated



Black Pearl



Black



Nickle



Gold



Rose Gold



**CAN BE MADE TO ORDER**  
DIMMABLE/TUNABLE WITH RF CONTROL

**PRODUCT PARAMETERS**

Model No.	Power	LED Chip	CRI	Lumens	CCT	Body Color	Beam Angle
LLF137	5W	BRIDGELUX COB	≥80	400Lm	3000K/4000K	Rose Gold	18°
LLF137A	12W	BRIDGELUX COB	≥80	960Lm	3000K/4000K	Rose Gold	38°
LLF137B	16W	BRIDGELUX COB	≥80	1280Lm	3000K/4000K	Rose Gold	38°

**PRODUCT DIMENSION**

Unit (mm)



**PRODUCT PARAMETERS**

Model No.	Power	LED Chip	CRI	Lumens	CCT	Body Color	Beam Angle
LLF138	5W	BRIDGELUX COB	≥80	400Lm	3000K/4000K	White	18°
LLF138A	12W	BRIDGELUX COB	≥80	960Lm	3000K/4000K	White	38°
LLF138B	16W	BRIDGELUX COB	≥80	1280Lm	3000K/4000K	White	38°

**PRODUCT DIMENSION**

Unit (mm)



**PRODUCT PARAMETERS**

Model No.	Power	LED Chip	CRI	Lumens	CCT	Body Color	Beam Angle
LLF139	5W	BRIDGELUX COB	≥80	400Lm	3000K/4000K	Black	18°
LLF139A	12W	BRIDGELUX COB	≥80	960Lm	3000K/4000K	Black	38°
LLF139B	16W	BRIDGELUX COB	≥80	1280Lm	3000K/4000K	Black	38°

**PRODUCT DIMENSION**

Unit (mm)





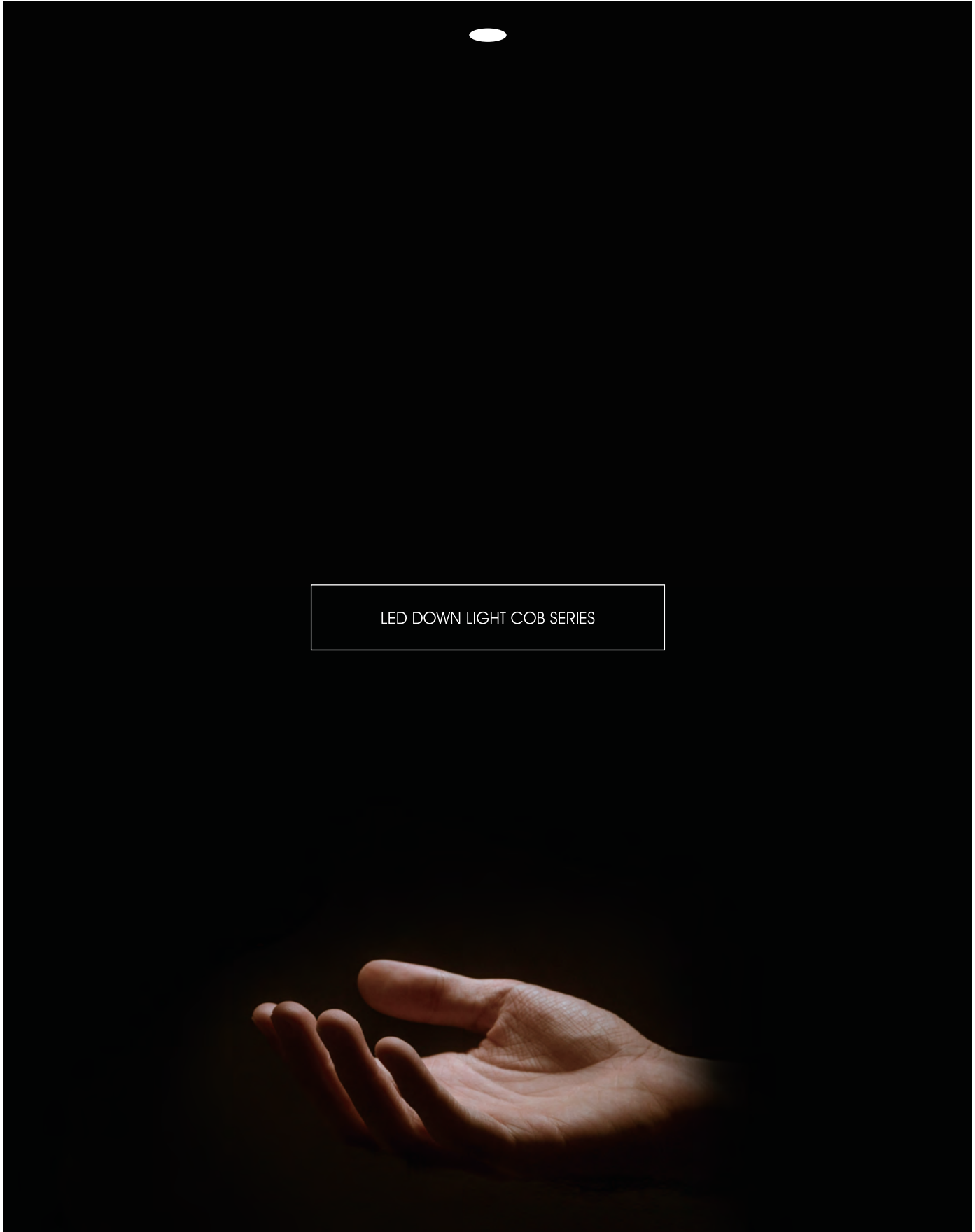

**CAN BE MADE TO ORDER**  
DIMMABLE/TUNABLE WITH RF CONTROL



LLF206



LLF207



LLF208

**PRODUCT PARAMETERS**



Model No.	Power	LED Chip	CRI	Lumens	CCT	Body Color	Beam Angle
LLF206	12W	CREE COB	≥80	80Lm/W	3000K/4000K	White	36°
LLF207	12W	CREE COB	≥80	80Lm/W	3000K/4000K	White	36°
LLF208	2*12W	CREE COB	≥80	80Lm/W	3000K/4000K	White	36°

**PRODUCT DIMENSION**

Unit (mm)



Ø91mm



Ø86mm

**LLF206-12W**  
Body Size: Ø91\*93mm  
Cut-Size: Ø86mm



91mm



86\*86mm

**LLF207-12W**  
Body Size: 91\*91\*93mm  
Cut-Size: 86\*86mm

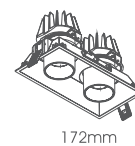

172mm

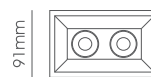

165\*86mm

**LLF208-2\*12W**  
Body Size: 172\*91\*93mm  
Cut-Size: 165\*86mm



## LED DOWN LIGHT COB SERIES

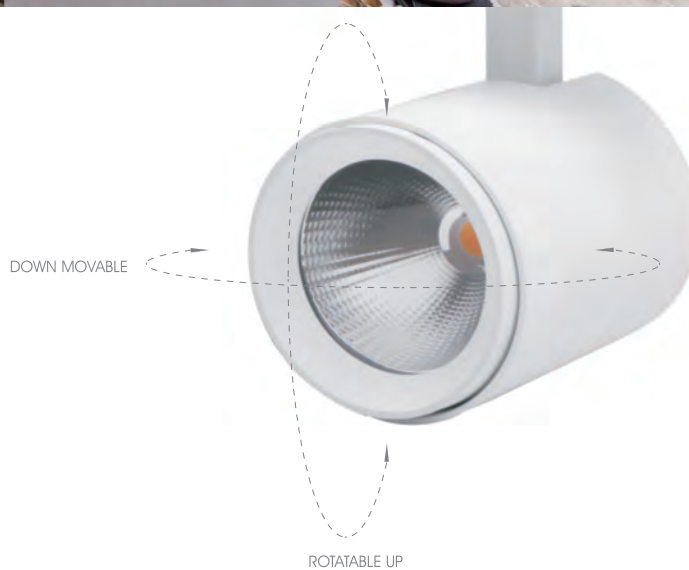



## PRODUCT PARAMETERS



Model No.	Power	LED Chip	CRI	Lumens	CCT	Body Color	Beam Angle
LLF200	5W	BRIDGELUX COB	≥80	375-425Lm	3000K/4000K/6000K	White	24°
LLF201	9W	BRIDGELUX COB	≥80	720-810Lm	3000K/4000K/6000K	White	24°
LLF202	16W	BRIDGELUX COB	≥80	1200-1360Lm	3000K/4000K/6000K	White	24°
LLF203	30W	BRIDGELUX COB	≥80	2250-2550Lm	3000K/4000K/6000K	White	24°

## PRODUCT DIMENSION

Unit (mm)

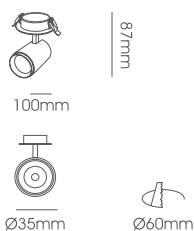

**LLF200-5W**  
Body Size: Ø35\*100\*87mm  
Cut-Size: Ø60mm

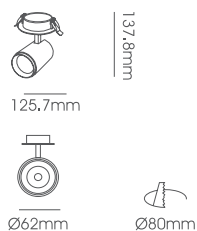

**LLF201-9W**  
Body Size: Ø62\*125.7\*137.8mm  
Cut-Size: Ø80mm

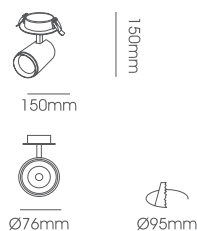

**LLF202-16W**  
Body Size: Ø76\*150\*150mm  
Cut-Size: Ø95mm

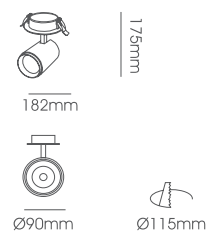

**LLF203-30W**  
Body Size: Ø90\*182\*175mm  
Cut-Size: Ø115mm



**CAN BE MADE TO ORDER**  
DIMMABLE/TUNABLE WITH RF CONTROL

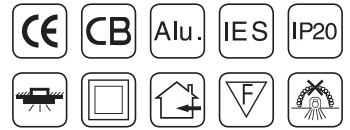

**PRODUCT PARAMETERS**



Model No.	Power	LED Chip	CRI	Lumens	CCT	Body Color	Beam Angle
LLF209	12W	BRIDGELUX COB	≥80	870Lm	3000K/4000K	Matt White	40°
LLF220	9W	CREE COB	≥80	720Lm	3000K/4000K	White	38°
LLF221	15W	CREE COB	≥80	1200Lm	3000K/4000K	White	38°
LLF222	20W	CREE COB	≥80	1600Lm	3000K/4000K	White	38°

**PRODUCT DIMENSION**

Unit (mm)

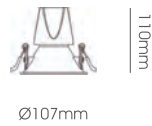

**LLF220-9W**  
Body Size: Ø90\*90mm  
Cut-Size: Ø80mm

**LLF221-15W**  
Body Size: Ø107\*110mm  
Cut-Size: Ø95mm

**LLF222-20W**  
Body Size: Ø135\*145mm  
Cut-Size: Ø125mm

**LLF209-12W**  
Body Size: Ø84\*90.9mm  
Cut-Size: Ø72mm

**CAN BE MADE TO ORDER**  
DIMMABLE/TUNABLE WITH RF CONTROL



LLF-237



LLF-236

**PRODUCT PARAMETERS**



Model No.	Power	LED Chip	CRI	Lumens	CCT	Body Color	Beam Angle
LLF236	9W	BRIDGELUX COB	≥80	720Lm	3000K/4000K	White / Black	40° (Shinland)
LLF237	15W	BRIDGELUX COB	≥80	1200Lm	3000K/4000K	White / Black	38° (Shinland)

**PRODUCT DIMENSION**

Unit (mm)

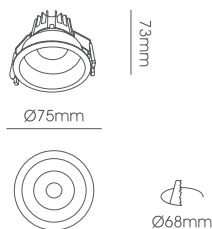

**LLF236-9W**  
Body Size: Ø75\*73mm  
Cut-Size: Ø68mm

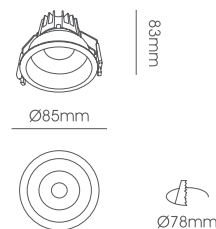

**LLF237-15W**  
Body Size: Ø85\*83mm  
Cut-Size: Ø78mm

# INDOOR LED LIGHT

LLF 210-215 SERIES

---



**CAN BE MADE TO ORDER**

DIMMABLE/TUNABLE WITH RF CONTROL

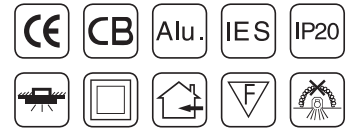

**PRODUCT PARAMETERS**



Model No.	Power	LED Chip	CRI	Lumens	CCT	Body Color	Beam Angle
LLF210	3W	CREE XTE	≥80	210-225Lm	3000K/4000K	White / Black	30°
LLF211	5W	CREE XTE	≥80	350-375Lm	3000K/4000K	White / Black	30°
LLF212	8W	CREE XTE	≥80	420-600Lm	3000K/4000K	White / Black	30°
LLF213	10W	CREE XTE	≥80	700-750Lm	3000K/4000K	White / Black	30°
LLF214	12W	CREE XTE	≥80	840-900Lm	3000K/4000K	White / Black	30°
LLF215	20W	CREE XTE	≥80	1260-1350Lm	3000K/4000K	White / Black	30°

**PRODUCT DIMENSION**

Unit (mm)

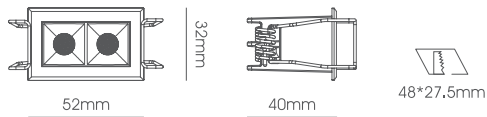

**LLF210-3W**  
Body Size: 52\*32\*40mm  
Cut-Size: 48\*27.5mm

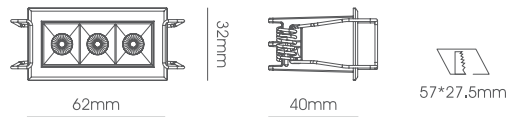

**LLF211-5W**  
Body Size: 62\*32\*40mm  
Cut-Size: 57\*27.5mm

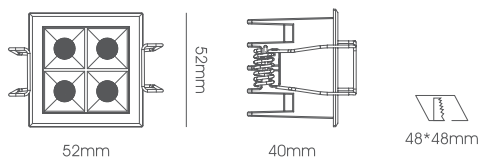

**LLF212-8W**  
Body Size: 52\*52\*40mm  
Cut-Size: 48\*48mm

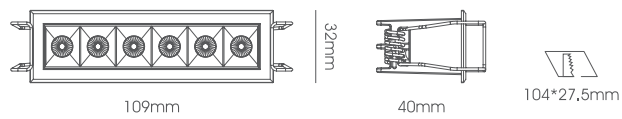

**LLF213-10W**  
Body Size: 109\*32\*40mm  
Cut-Size: 104\*27.5mm

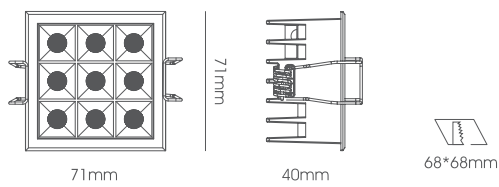

**LLF214-12W**  
Body Size: 71\*71\*40mm  
Cut-Size: 68\*68mm

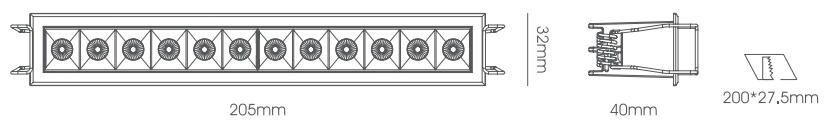

**LLF215-20W**  
Body Size: 205\*32\*40mm  
Cut-Size: 200\*27.5mm



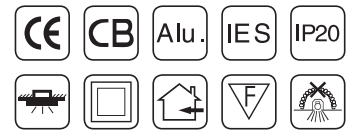

**PRODUCT PARAMETERS**



Model No.	Power	LED Chip	CRI	Lumens	CCT	Body Color	Beam Angle
LLF226	3W	BRIDGELUX COB	≥80	240Lm	3000K/4000K	White / Black	24° (Shinland)
LLF227	6W	BRIDGELUX COB	≥80	480Lm	3000K/4000K	White / Black	40° (Shinland)
LLF228	12W	BRIDGELUX COB	≥80	960Lm	3000K/4000K	White / Black	38° (Shinland)

**PRODUCT DIMENSION**

Unit (mm)

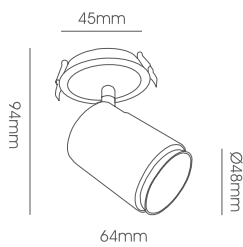

**LLF226-3W**  
Body Size: Ø48\*64\*94mm  
Cut-Size: Ø45mm

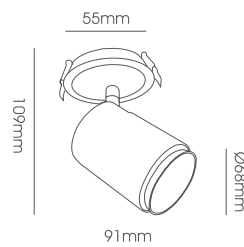

**LLF227-6W**  
Body Size: Ø68\*91\*109mm  
Cut-Size: Ø55mm

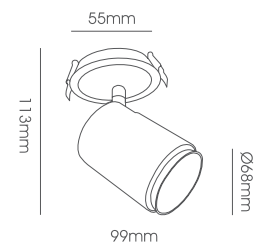

**LLF228-12W**  
Body Size: Ø68\*99\*113mm  
Cut-Size: Ø55mm

**CAN BE MADE TO ORDER**  
DIMMABLE/TUNABLE WITH RF CONTROL



LLF-229/LLF-230



LLF-231/LLF-232

**PRODUCT PARAMETERS**



Model No.	Power	LED Chip	CRI	Lumens	CCT	Body Color	Beam Angle
LLF229	10W	BRIDGELUX COB	≥80	800Lm	3000K/4000K/6000K	White / Black	30° (Xin Optics)
LLF230	18W	BRIDGELUX COB	≥80	1440Lm	3000K/4000K/6000K	White / Black	30° (Xin Optics)
LLF231	10W	BRIDGELUX COB	≥80	800Lm	3000K/4000K/6000K	White / Black	30° (Xin Optics)
LLF232	18W	BRIDGELUX COB	≥80	1440Lm	3000K/4000K/6000K	White / Black	30° (Xin Optics)

\* Honeycomb Reflector

**PRODUCT DIMENSION**

Unit (mm)



**LLF229-10W**  
Body Size: 136\*Ø84\*130mm  
Cut-Size: Ø75mm

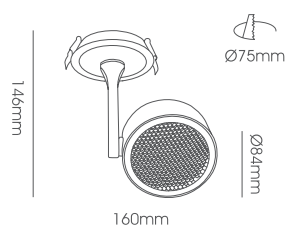

**LLF230-18W**  
Body Size: 160\*Ø84\*146mm  
Cut-Size: Ø75mm

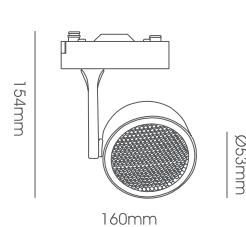

**LLF231-10W**  
Body Size:  
160\*Ø53\*154mm

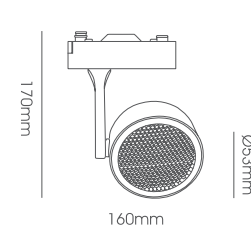

**LLF232-18W**  
Body Size:  
160\*Ø53\*170mm



**CAN BE MADE TO ORDER**  
DIMMABLE/TUNABLE WITH RF CONTROL



**PRODUCT PARAMETERS**



Model No.	Power	LED Chip	CRI	Lumens	CCT	Body Color	Beam Angle
LLF233	6W	BRIDGELUX COB	≥80	480Lm	3000K/4000K	White / Black	24° (Shinland)
LLF234	12W	BRIDGELUX COB	≥80	960Lm	3000K/4000K	White / Black	40° (Shinland)
LLF235	18W	BRIDGELUX COB	≥80	1440Lm	3000K/4000K	White / Black	38° (Shinland)

**PRODUCT DIMENSION**

Unit (mm)

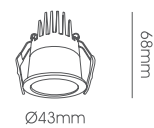

**LLF233-6W**  
Body Size: Ø43\*68mm  
Cut-Size: Ø35mm

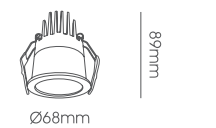

**LLF234-12W**  
Body Size: Ø68\*89mm  
Cut-Size: Ø60mm

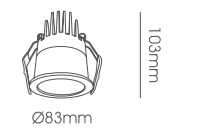

**LLF235-18W**  
Body Size: Ø83\*103mm  
Cut-Size: Ø75mm





# HIGH END

COB DOWN LIGHTER'S

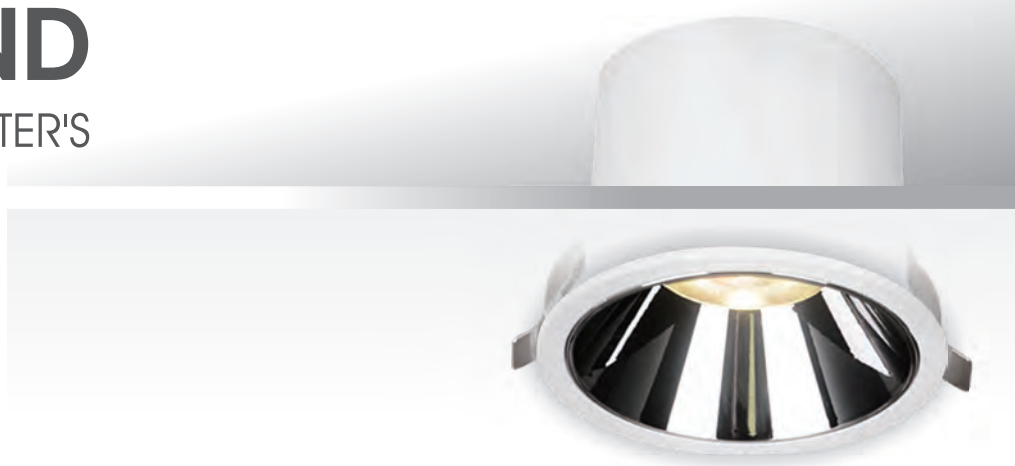

**CAN BE MADE TO ORDER**  
DIMMABLE/TUNABLE WITH RF CONTROL



**PRODUCT PARAMETERS**



Model No.	Power	LED Chip	CRI	Lumens	CCT	Body Color	Beam Angle
LLF238	9W	CREE COB	≥80	720Lm	3000K/4000K	White / Black	38°
LLF239	15W	CREE COB	≥80	1200Lm	3000K/4000K	White / Black	38°
LLF240	20W	CREE COB	≥80	1600Lm	3000K/4000K	White / Black	38°

**PRODUCT DIMENSION**

Unit (mm)

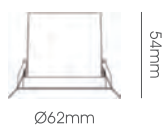

**LLF238-9W**  
Body Size: Ø62\*54mm  
Cut-Size: Ø55mm

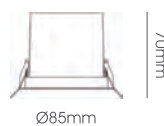

**LLF239-15W**  
Body Size: Ø85\*70mm  
Cut-Size: Ø75mm



**LLF240-20W**  
Body Size: Ø105\*85mm  
Cut-Size: Ø95mm



# HIGH END

COB DOWN LIGHTER'S



**CAN BE MADE TO ORDER**  
DIMMABLE/TUNABLE WITH RF CONTROL

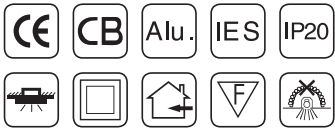

LLF243



LLF242



LLF241

**PRODUCT PARAMETERS**



Model No.	Power	LED Chip	CRI	Lumens	CCT	Body Color	Beam Angle
LLF241	5W	CREE COB	≥80	400Lm	3000K/4000K	White / Black	40°
LLF242	8W	CREE COB	≥80	640Lm	3000K/4000K	White / Black	40°
LLF243	8W	CREE COB	≥80	640Lm	3000K/4000K	White	40°

**PRODUCT DIMENSION**

Unit (mm)

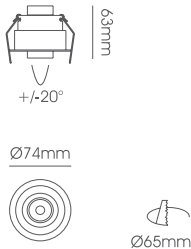

**LLF241-5W**  
Body Size: Ø74\*63mm  
Cut-Size: Ø65mm

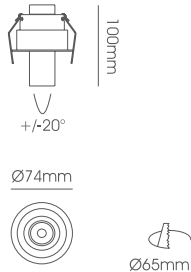

**LLF242-8W**  
Body Size: Ø74\*100mm  
Cut-Size: Ø65mm

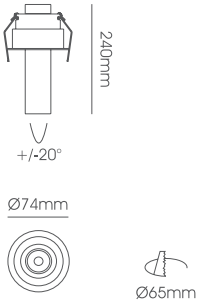

**LLF243-8W**  
Body Size: Ø74\*240mm  
Cut-Size: Ø65mm





**CAN BE MADE TO ORDER**

DIMMABLE/TUNABLE WITH RF CONTROL



**PRODUCT PARAMETERS**



Model No.	Power	LED Chip	CRI	Lumens	CCT	Body Color	Beam Angle
LLF244	9W	CREE COB	≥80	720Lm	3000K/4000K	White	38°
LLF245	15W	CREE COB	≥80	1200Lm	3000K/4000K	White	38°
LLF246	2*9W	CREE COB	≥80	1440Lm	3000K/4000K	White	38°
LLF247	2*15W	CREE COB	≥80	2400Lm	3000K/4000K	White	38°

**PRODUCT DIMENSION**

Unit (mm)

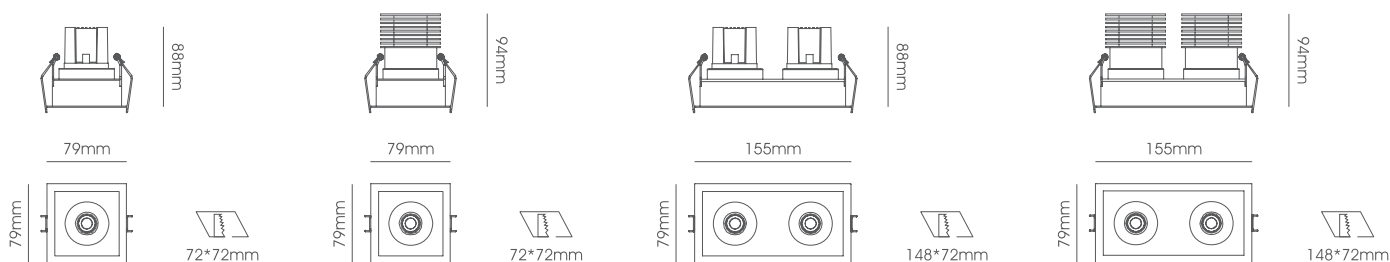

**LLF244-9W**  
Body Size: 79\*79\*88mm  
Cut-Size: 72\*72mm

**LLF245-15W**  
Body Size: 79\*79\*94mm  
Cut-Size: 72\*72mm

**LLF246-2\*9W**  
Body Size: 155\*79\*88mm  
Cut-Size: 148\*72mm

**LLF247-2\*15W**  
Body Size: 155\*79\*94mm  
Cut-Size: 148\*72mm



LED DOWN LIGHT COB SERIES



**CAN BE MADE TO ORDER**  
DIMMABLE/TUNABLE WITH RF CONTROL

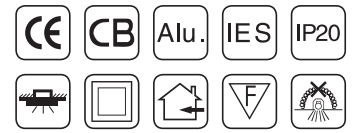

**PRODUCT PARAMETERS**



Model No.	Power	LED Chip	CRI	Lumens	CCT	Body Color	Beam Angle
LLF248	10-15W	BRIDGELUX COB	≥80	900-1350Lm	3000K/4000K/6000K	White / Black	15°/24°/36°
LLF249	15-20W	BRIDGELUX COB	≥80	1350-1800Lm	3000K/4000K/6000K	White / Black	15°/24°/36°
LLF250	20-25W	BRIDGELUX COB	≥80	1800-2200Lm	3000K/4000K/6000K	White / Black	15°/24°/36°
LLF251	30-35W	BRIDGELUX COB	≥80	2700-3150Lm	3000K/4000K/6000K	White / Black	15°/24°/36°
LLF252	40-50W	BRIDGELUX COB	≥80	3600-4500Lm	3000K/4000K/6000K	White / Black	15°/24°/36°

**PRODUCT DIMENSION**

Unit (mm)

<p><b>LLF248/10-15W</b> Body Size: Ø75*85mm Cut-Size: Ø65mm</p>	<p><b>LLF249/15-20W</b> Body Size: Ø85*90mm Cut-Size: Ø75mm</p>	<p><b>LLF250/20-25W</b> Body Size: Ø95*105mm Cut-Size: Ø85mm</p>	<p><b>LLF251/30-35W</b> Body Size: Ø113*105mm Cut-Size: Ø100mm</p>	<p><b>LLF252/40-45W</b> Body Size: Ø135*130mm Cut-Size: Ø120mm</p>





**LED HIGH END  
DOWN LIGHTER'S-COB**

**CAN BE MADE TO ORDER**  
DIMMABLE/TUNABLE WITH RF CONTROL

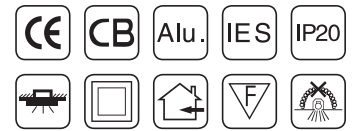

LLF253



LLF254



LLF255

**PRODUCT PARAMETERS**



Model No.	Power	LED Chip	CRI	Lumens	CCT	Body Color	Beam Angle
LLF253	5W	BRIDGELUX COB	≥90	390-430Lm	3000K/4000K	Matt White / Matt Black	36°
LLF254	10W	BRIDGELUX COB	≥90	670-750Lm	3000K/4000K	Matt White / Matt Black	36°
LLF255	15W	BRIDGELUX COB	≥90	1040-1100Lm	3000K/4000K	Matt White / Matt Black	36°

**PRODUCT DIMENSION**

Unit (mm)

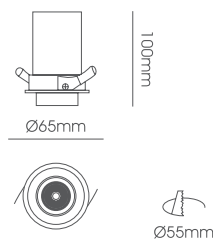

**LLF253-5W**  
Body Size: Ø65\*100mm  
Cut-Size: Ø55mm

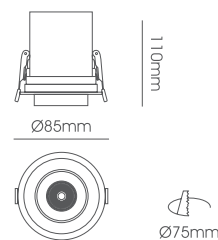

**LLF254-10W**  
Body Size: Ø85\*110mm  
Cut-Size: Ø75mm

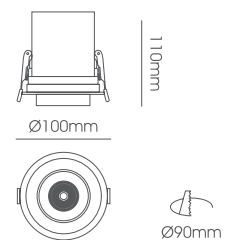

**LLF255-15W**  
Body Size: Ø100\*110mm  
Cut-Size: Ø90mm



# LED Lum

Lighting.Simplified

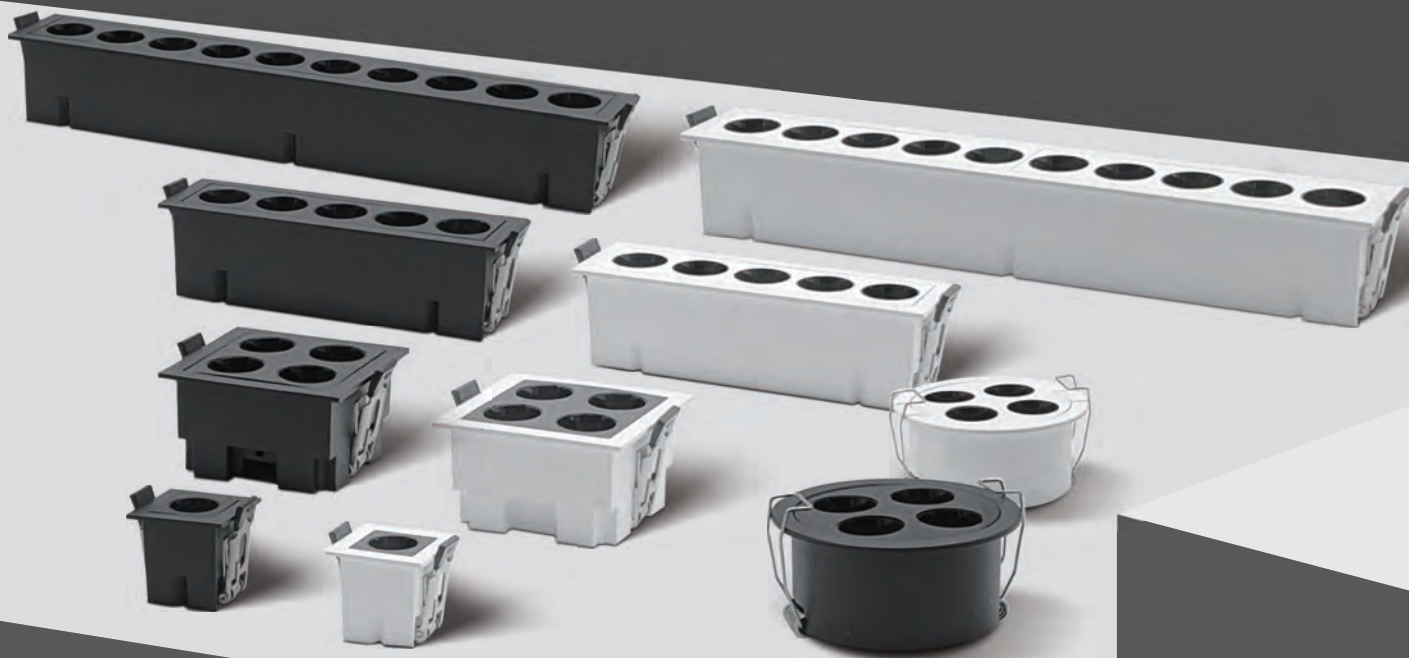





# LED HIGH END

DOWN LIGHTER'S-COB

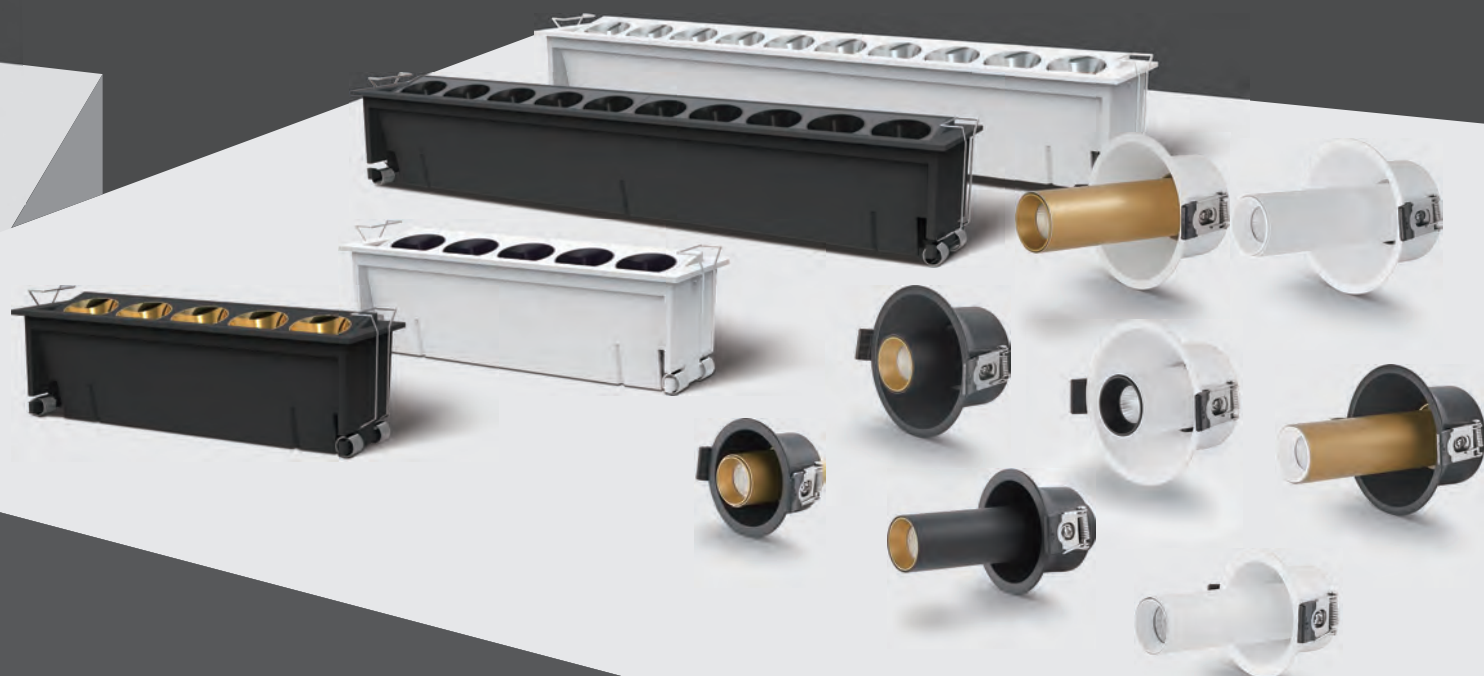



**WALL WASHER-TIL TABLE**

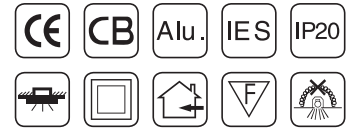

**LLF261**



**LLF262**

**PRODUCT PARAMETERS**



Model No.	Power	LED Chip	CRI	Lumens	CCT	Body Color	Beam Angle
LLF261	12W	BRIDGELUX SMD	≥90	605-710Lm	3000K/4000K	Matt White / Matt Black	Wall Washer
LLF262	24W	BRIDGELUX SMD	≥90	1275-1460Lm	3000K/4000K	Matt White / Matt Black	Wall Washer

**PRODUCT DIMENSION**

Unit (mm)

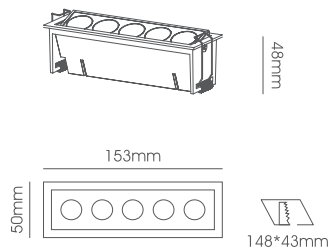

**LLF261-12W**  
Body Size: 153\*50\*48mm  
Cut-Size: 148\*43mm

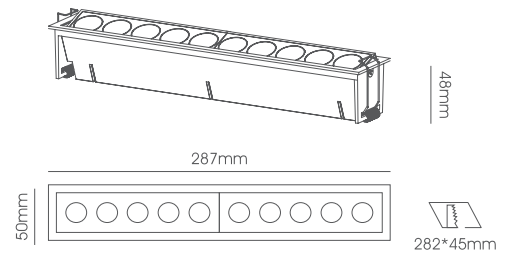

**LLF262-24W**  
Body Size: 287\*50\*48mm  
Cut-Size: 282\*45mm

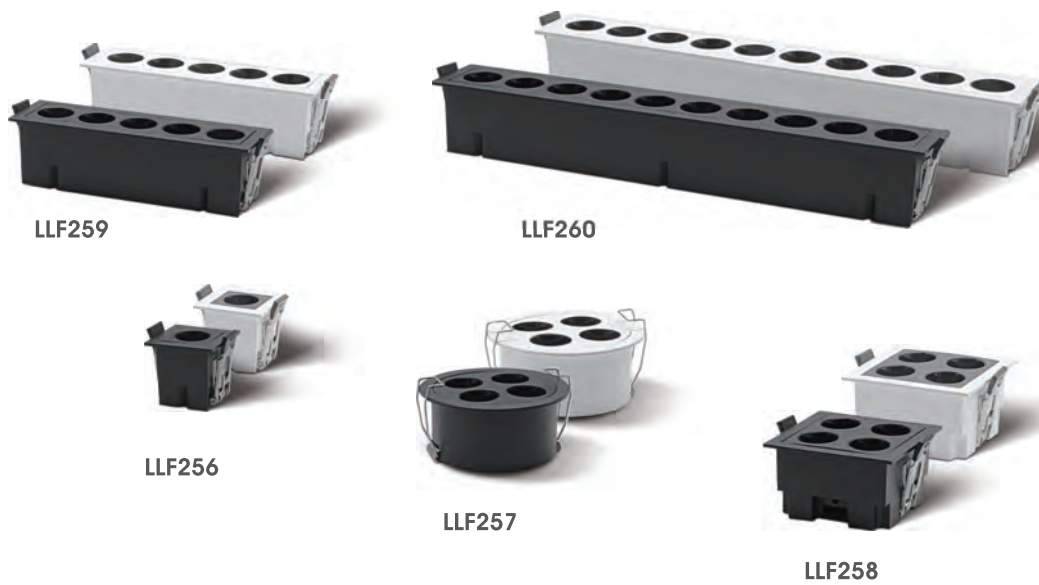
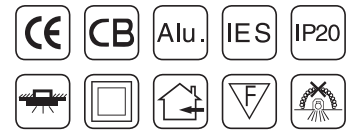

PRODUCT PARAMETERS



Model No.	Power	LED Chip	CRI	Lumens	CCT	Body Color	Beam Angle
LLF256	3W	BRIDGELUX SMD	≥90	105-110Lm	3000K/4000K	Matt White / Matt Black	36°
LLF257	10W	BRIDGELUX SMD	≥90	440-530Lm	3000K/4000K	Matt White / Matt Black	36°
LLF258	10W	BRIDGELUX SMD	≥90	500-560Lm	3000K/4000K	Matt White / Matt Black	36°
LLF259	12W	BRIDGELUX SMD	≥90	610-730Lm	3000K/4000K	Matt White / Matt Black	36°
LLF260	24W	BRIDGELUX SMD	≥90	1150-1350Lm	3000K/4000K	Matt White / Matt Black	36°

PRODUCT DIMENSION

Unit (mm)

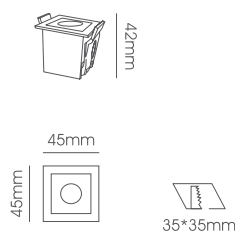

**LLF256-3W**  
Body Size: 45\*45\*42mm  
Cut-Size: 35\*35mm

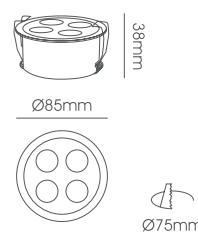

**LLF257-10W**  
Body Size: Ø85\*38mm  
Cut-Size: Ø75mm

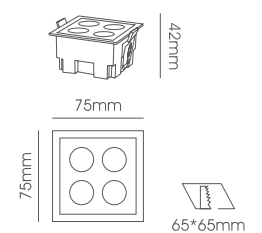

**LLF258-10W**  
Body Size: 75\*75\*42mm  
Cut-Size: 65\*65mm

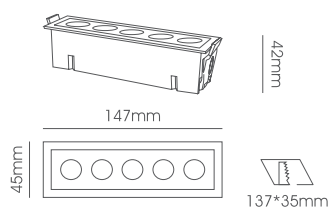

**LLF259-12W**  
Body Size: 147\*45\*42mm  
Cut-Size: 137\*35mm

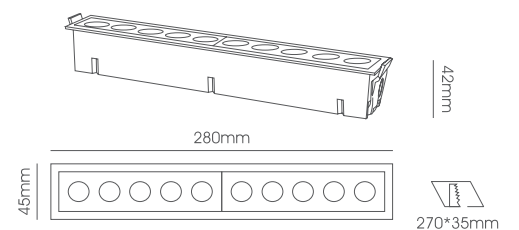

**LLF260-24W**  
Body Size: 280\*45\*42mm  
Cut-Size: 270\*35mm

**CAN BE MADE TO ORDER**  
DIMMABLE/TUNABLE WITH RF CONTROL

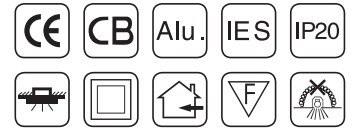

**LLF263**



**LLF264**



**LLF263A**

**PRODUCT PARAMETERS**



Model No.	Power	LED Chip	CRI	Lumens	CCT	Body Color	Beam Angle
LLF263	5W	BRIDGELUX COB	≥90	405-450Lm	3000K/4000K	Matt White / Matt Black	24°
LLF264	5W	BRIDGELUX COB	≥90	415-480Lm	3000K/4000K	Matt White / Matt Black	24°
LLF263A	/	/	/	/	/	Matt White / Matt Black	/

**PRODUCT DIMENSION**

Unit (mm)

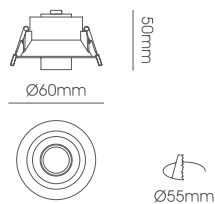

**LLF263-5W**  
Body Size: Ø60\*50mm  
Cut-Size: Ø55mm

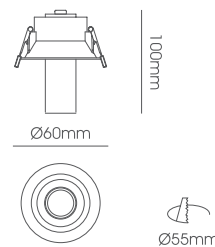

**LLF264-5W**  
Body Size: Ø60\*100mm  
Cut-Size: Ø55mm

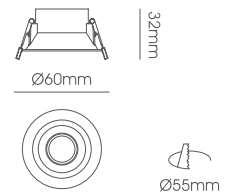

**LLF263A**  
Body Size: Ø60\*32mm  
Cut-Size: Ø55mm

**CAN BE MADE TO ORDER**  
DIMMABLE/TUNABLE WITH RF CONTROL

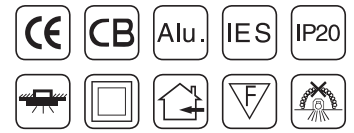

**LLF265**



**LLF267**



**LLF266**



**LLF265A**

**PRODUCT PARAMETERS**



Model No.	Power	LED Chip	CRI	Lumens	CCT	Body Color	Beam Angle
LLF265	7W	BRIDGELUX COB	≥90	545-645Lm	3000K/4000K	Matt White / Matt Black / Matt Gold	24°
LLF266	7W	BRIDGELUX COB	≥90	450-635Lm	3000K/4000K	Matt White / Matt Black / Matt Gold	24°
LLF267	7W	BRIDGELUX COB	≥90	535-620Lm	3000K/4000K	Matt White / Matt Black / Matt Gold	24°
LLF265A	/	/	/	/	/	Matt White / Matt Black	/

**PRODUCT DIMENSION**

Unit (mm)

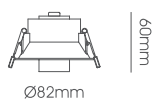

**LLF265-7W**  
Body Size: Ø82\*60mm  
Cut-Size: Ø75mm

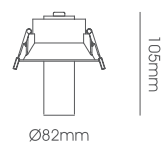

**LLF266-7W**  
Body Size: Ø82\*105mm  
Cut-Size: Ø75mm

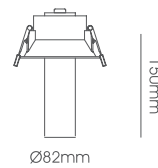

**LLF267-7W**  
Body Size: Ø82\*150mm  
Cut-Size: Ø75mm

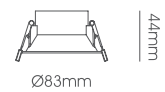

**LLF265A**  
Body Size: Ø83\*44mm  
Cut-Size: Ø75mm



**CAN BE MADE TO ORDER**  
DIMMABLE/TUNABLE WITH RF CONTROL

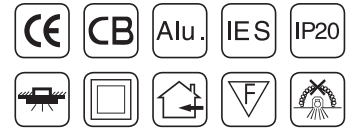

**PRODUCT PARAMETERS**



Model No.	Power	LED Chip	CRI	Lumens	CCT	Body Color	Beam Angle
LLF268	7W	BRIDGELUX COB	≥90	80lm/W	3000K/4000K/6000K	Black / White	15°/24°/36°
LLF269	12W	BRIDGELUX COB	≥90	80lm/W	3000K/4000K/6000K	Black / White	15°/24°/36°/60°
LLF270	20W	BRIDGELUX COB	≥90	80lm/W	3000K/4000K/6000K	Black / White	24°/36°/60°
LLF271	30W	BRIDGELUX COB	≥90	80lm/W	3000K/4000K/6000K	Black / White	24°/36°/60°

**PRODUCT DIMENSION**

Unit (mm)

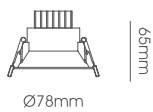

**LLF268-7W**  
Body Size: Ø78\*65mm  
Cut-Size: Ø72mm

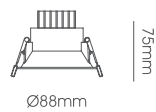

**LLF269-12W**  
Body Size: Ø88\*75mm  
Cut-Size: Ø80mm

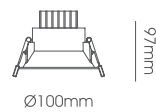

**LLF270-20W**  
Body Size: Ø100\*97mm  
Cut-Size: Ø94mm

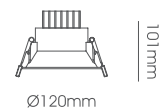

**LLF271-30W**  
Body Size: Ø120\*101mm  
Cut-Size: Ø113mm

**CAN BE MADE TO ORDER**  
DIMMABLE/TUNABLE WITH RF CONTROL

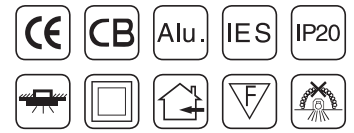

**PRODUCT PARAMETERS**



Model No.	Power	LED Chip	CRI	Lumens	CCT	Body Color	Beam Angle
LLF272	7W	BRIDGELUX COB	≥90	80lm/W	3000K/4000K/6000K	Black / White	15°/24°/36°
LLF273	12W	BRIDGELUX COB	≥90	80lm/W	3000K/4000K/6000K	Black / White	15°/24°/36°/60°
LLF274	20W	BRIDGELUX COB	≥90	80lm/W	3000K/4000K/6000K	Black / White	24°/36°/60°

**PRODUCT DIMENSION**

Unit (mm)

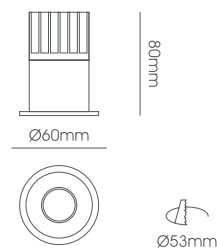

**LLF272-7W**  
Body Size: Ø60\*80mm  
Cut-Size: Ø53mm

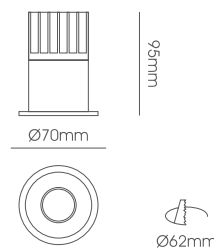

**LLF273-12W**  
Body Size: Ø70\*95mm  
Cut-Size: Ø62mm

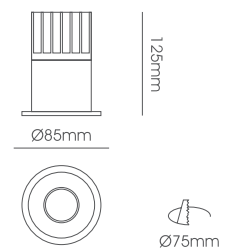

**LLF274-20W**  
Body Size: Ø85\*125mm  
Cut-Size: Ø75mm

**CAN BE MADE TO ORDER**  
DIMMABLE/TUNABLE WITH RF CONTROL

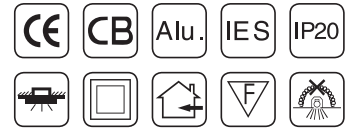

**PRODUCT PARAMETERS**



Model No.	Power	LED Chip	CRI	Lumens	CCT	Body Color	Beam Angle
LLF275	7W	BRIDGELUX COB	≥90	80Lm/W	3000K/4000K/6000K	White	26°
LLF276	12W	BRIDGELUX COB	≥90	80Lm/W	3000K/4000K/6000K	White	20°/40°

**PRODUCT DIMENSION**

Unit (mm)

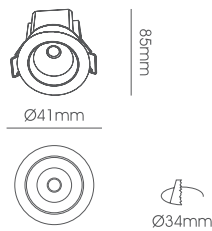

**LLF275-7W**  
Body Size: Ø41\*85mm  
Cut-Size: Ø34mm

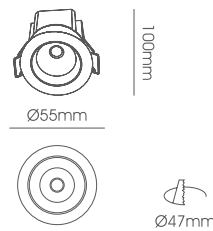

**LLF276-12W**  
Body Size: Ø55\*100mm  
Cut-Size: Ø47mm

**CAN BE MADE TO ORDER**  
DIMMABLE/TUNABLE WITH RF CONTROL

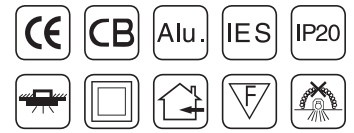

**PRODUCT PARAMETERS**



Model No.	Power	LED Chip	CRI	Lumens	CCT	Body Color	Beam Angle
LLF278	7W	BRIDGELUX COB	≥90	80lm/W	3000K/4000K/6000K	Black / White	15°/24°/36°
LLF279	12W	BRIDGELUX COB	≥90	80lm/W	3000K/4000K/6000K	Black / White	15°/24°/36°/60°
LLF280	20W	BRIDGELUX COB	≥90	80lm/W	3000K/4000K/6000K	Black / White	24°/36°/60°

**PRODUCT DIMENSION**

Unit (mm)

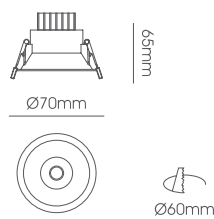

**LLF278-7W**  
Body Size: Ø70\*65mm  
Cut-Size: Ø60mm

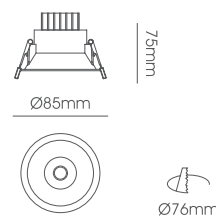

**LLF279-12W**  
Body Size: Ø85\*75mm  
Cut-Size: Ø76mm

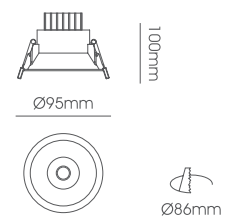

**LLF280-20W**  
Body Size: Ø95\*100mm  
Cut-Size: Ø86mm

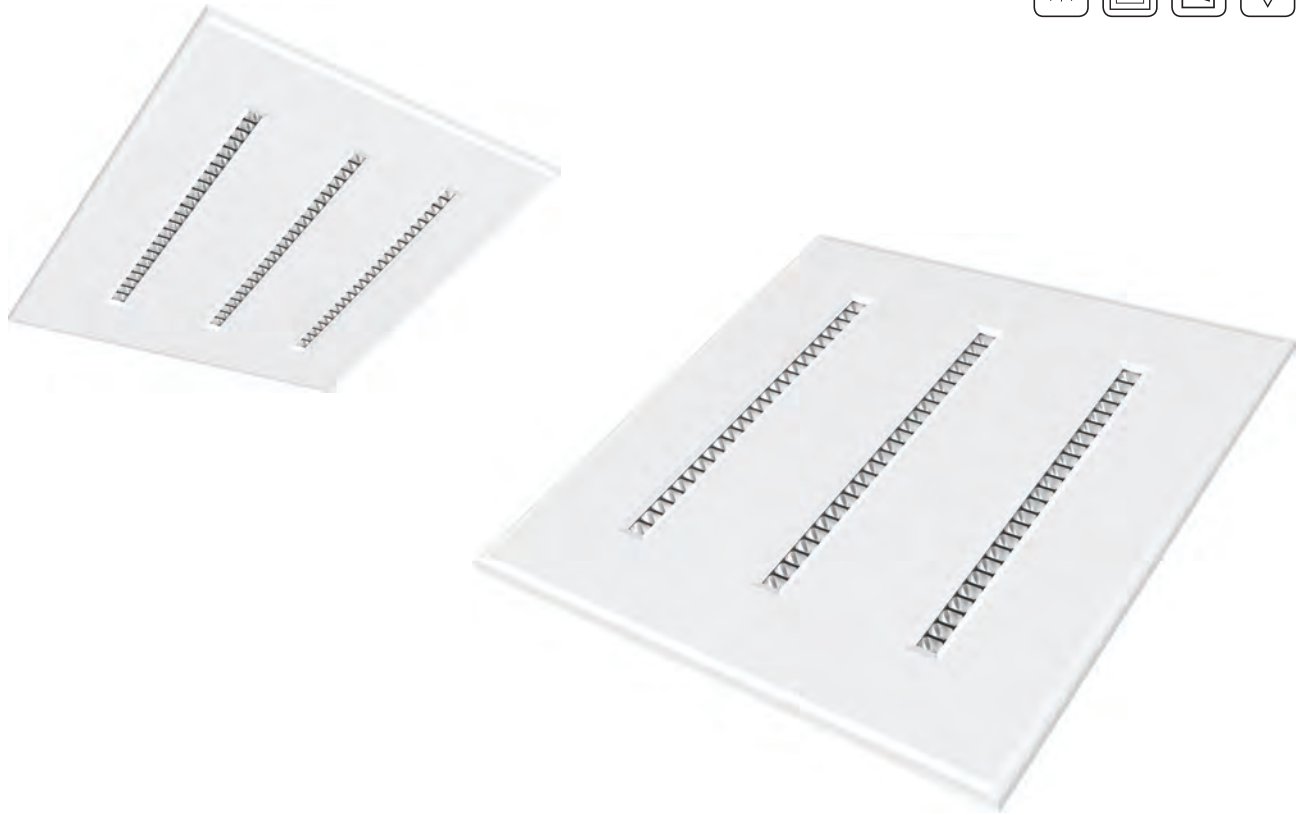
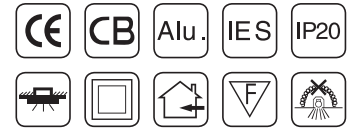

**PRODUCT PARAMETERS**

**EPISTAR**

Model No.	Power	LED Chip	CRI	Lumens	CCT	Body Color	Beam Angle
LLF285	40W	EPISTAR SMD	≥80	90-100lm/W	3000K/4000K/6000K	White	48°

**PRODUCT DIMENSION**

Unit (mm)

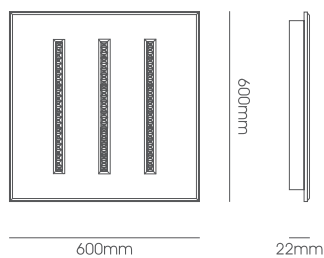

**LLF285-40W**  
Body Size:600\*600\*22mm  
Cut-Size: 590\*590mm



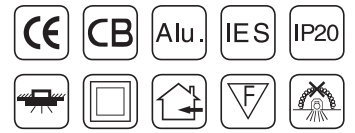

PRODUCT PARAMETERS

EPISTAR

Model No.	Power	LED Chip	CRI	Lumens	CCT	Body Color	Beam Angle
LLF281	10W	EPISTAR SMD	≥80	90-100lm/W	3000K/4000K/6000K	White	48°
LLF282	20W	EPISTAR SMD	≥80	90-100lm/W	3000K/4000K/6000K	White	48°
LLF283	30W	EPISTAR SMD	≥80	90-100lm/W	3000K/4000K/6000K	White	48°
LLF284	40W	EPISTAR SMD	≥80	90-100lm/W	3000K/4000K/6000K	White	48°

PRODUCT DIMENSION

Unit (mm)

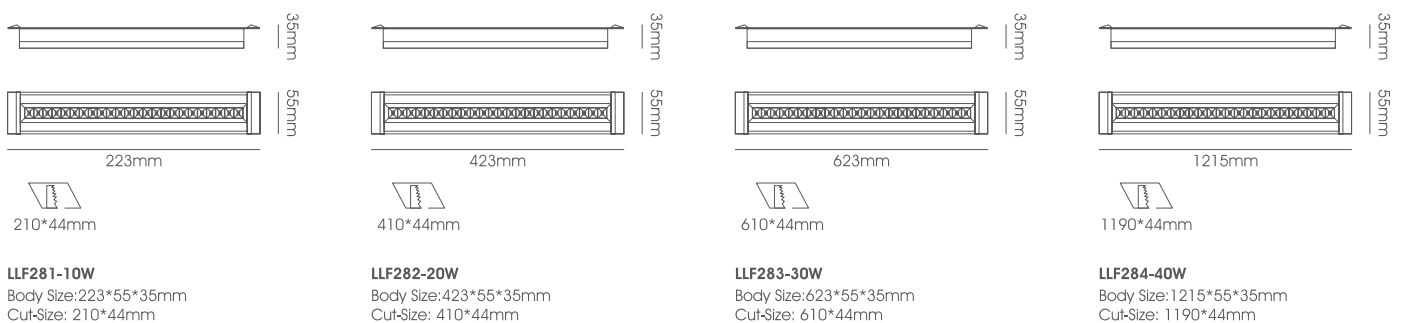

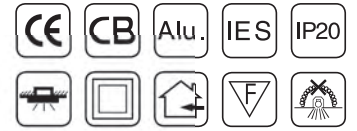

Sand white



Sand black



Bronze



Chrome



Rose gold

**PRODUCT PARAMETERS**



Model No.	Power	LED Chip	CRI	Lumens	CCT	Body Color	Beam Angle
LLF286	5W	CREE COB	≥90	60lm/W	3000K/4000K/6000K	Sand White / Sand Black / Rose Gold / Chrome / Bronze	38°
LLF287	7W	CREE COB	≥90	60lm/W	3000K/4000K/6000K		38°
LLF288	12W	CREE COB	≥90	60lm/W	3000K/4000K/6000K		38°

**PRODUCT DIMENSION**

Unit (mm)

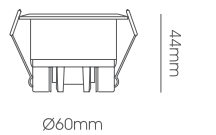

**LLF286-5W**  
Body Size: Ø60\*44mm  
Cut-Size: Ø50mm

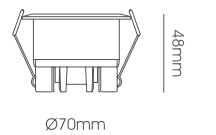

**LLF287-7W**  
Body Size: Ø70\*48mm  
Cut-Size: Ø60mm

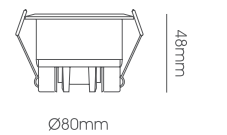

**LLF288-12W**  
Body Size: Ø80\*48mm  
Cut-Size: Ø70mm

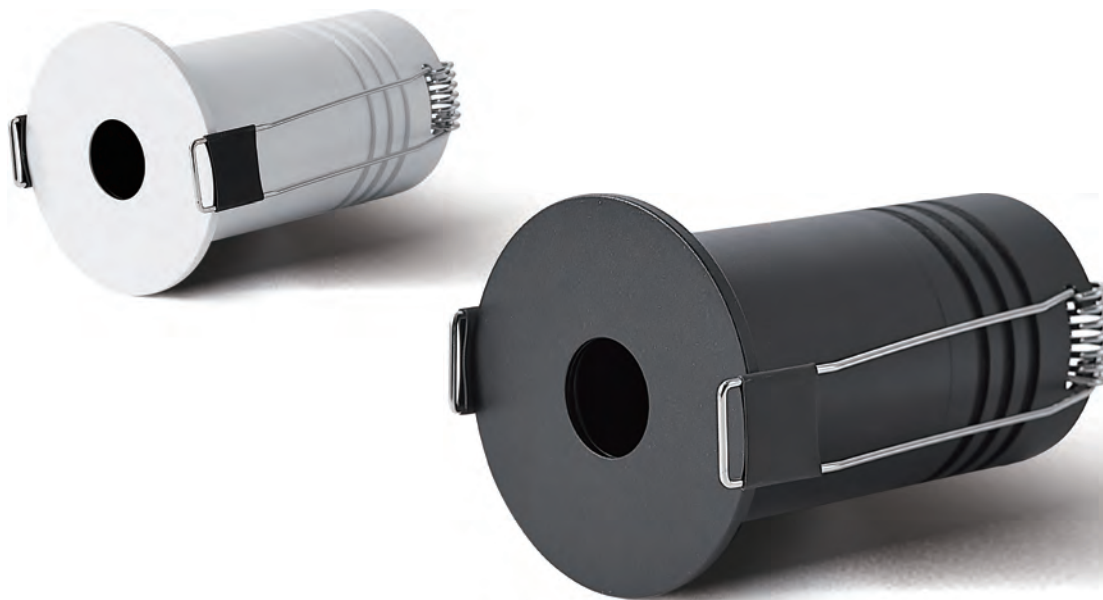

## PRODUCT PARAMETERS



Model No.	Power	LED Chip	CRI	Lumens	CCT	Body Color	Beam Angle
LLF289	3W	BRIDGELUX 3535	≥90	60lm/W	3000K/4000K/6000K	Sand White / Sand Black	24°
LLF290	5W	BRIDGELUX SMD	≥90	60lm/W	3000K/4000K/6000K	Sand White / Sand Black	24°
LLF291	9W	BRIDGELUX SMD	≥90	60lm/W	3000K/4000K/6000K	Sand White / Sand Black	24°

## PRODUCT DIMENSION

Unit (mm)

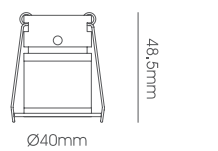

**LLF289-3W**  
Body Size: Ø40\*48.5mm  
Cut-Size: Ø35mm

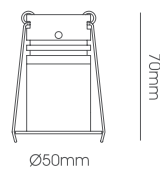

**LLF290-5W**  
Body Size: Ø50\*70mm  
Cut-Size: Ø45mm

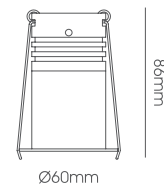

**LLF291-9W**  
Body Size: Ø60\*86mm  
Cut-Size: Ø55mm



# LED COB DOWN LIGHT SERIES

Driving Different Scenarios  
When creating highlights, also being illuminated by them



APPLICATION SCENARIO

office

hotel

family

## LED COB DOWN LIGHT SERIES



LLF276-FIXED



LLF275-FIXED



LLF275A-MOVEABLE



LLF276A-MOVEABLE

### PRODUCT PARAMETERS



Model No.	Power	LED Chip	CRI	Lumens	CCT	Body Color	Beam Angle
LLF275-FIXED	7W	Bridgelux C6	≥90	473.46Lm	3000K/4000K/6000K	Black / White	40°
LLF276-FIXED	12W	Bridgelux C8	≥90	864.92Lm	3000K/4000K/6000K	Black / White	20°
LLF275A-MOVEABLE	7W	Bridgelux C6	≥90	414.99Lm	3000K/4000K/6000K	Black / White	40°
LLF276A-MOVEABLE	12W	Bridgelux C8	≥90	921.84Lm	3000K/4000K/6000K	Black / White	60°

### PRODUCT DIMENSION

Unit(mm)

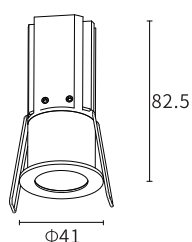

LLF275-FIXED-7W  
Body Size :Ø41\*82.5  
Cut-Size : Ø35

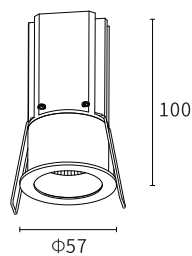

LLF276-FIXED-12W  
Body Size :Ø57\*100  
Cut-Size : Ø50

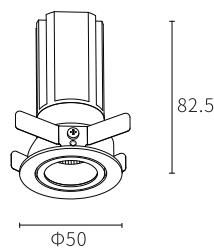

LLF275A-MOVEABLE-7W  
Body Size :Ø50\*82.52  
Cut-Size : Ø47

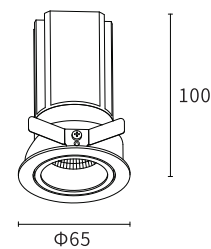

LLF276A-MOVEABLE-12W  
Body Size :Ø65\*100  
Cut-Size : Ø62



# LED COB DOWN LIGHT SERIES

---

Wide area illumination  
Multiple anti glare measures, comfortable eye protection throughout the house



#### APPLICATION SCENARIO

- office
- hotel
- family

LED COB DOWN LIGHT  
SERIES

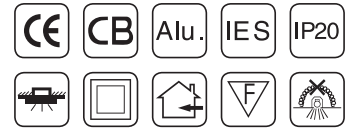

LLF295



LLF296

PRODUCT PARAMETERS



Model No.	Power	LED Chip	CRI	Lumens	CCT	Body Color	Beam Angle
LLF295	7W	CREE	≥90	595Lm	3000K/4000K/5700K	White	36°
LLF296	12W	CREE	≥90	1275Lm	3000K/4000K/5700K	White	36°

PRODUCT DIMENSION

Unit(mm)

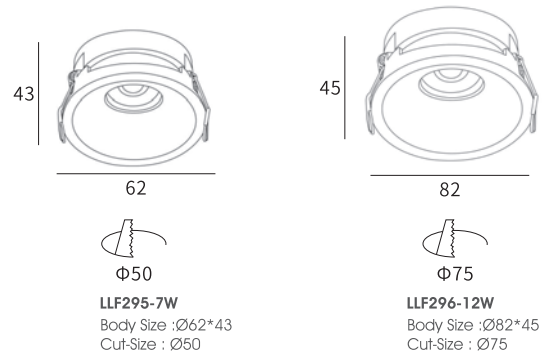

# LED COB DOWN LIGHT SERIES

Stable performance without video flashing  
Uniform, soft, delicate and natural light, healthy and eye care



## APPLICATION SCENARIO

office

hotel

family

LED COB DOWN LIGHT  
SERIES

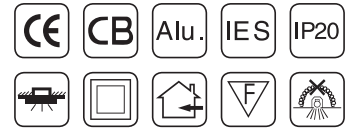

Options Accessory

HONEY COMB



PRODUCT PARAMETERS



Model No.	Power	LED Chip	CRI	Lumens	CCT	Body Color	Beam Angle
LLF297	7W	CREE	≥90	525Lm	3000K/4000K/5700K	White / Black	38°
LLF298	12W	CREE	≥90	900Lm	3000K/4000K/5700K	White / Black	38°
LLF299	20W	CREE	≥90	1500Lm	3000K/4000K/5700K	White / Black	38°

PRODUCT DIMENSION

Unit(mm)

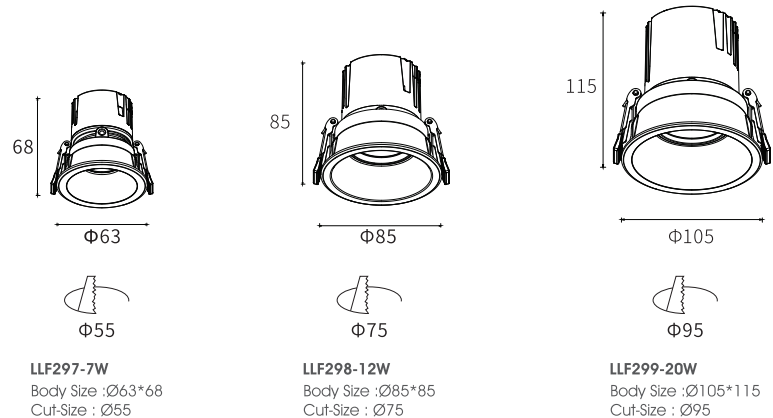



# LED COB DOWN LIGHT SERIES

Flexible angle adjustment in all directions  
Easily meet the lighting needs of different spaces



#### APPLICATION SCENARIO

office

hotel

family



## LED COB DOWN LIGHT SERIES



### PRODUCT PARAMETERS



Model No.	Power	LED Chip	CRI	Lumens	CCT	Body Color	Beam Angle
LLF300	12W	Bridglux C8	≥90	961.94Lm	3000K/4000K/6000K	White	24°/36°
LLF300A	12W	Bridglux C8	≥90	775.36Lm	3000K/4000K/6000K	White	24°/36°
LLF300B	12W	Bridglux C8	≥90	223.56Lm	3000K/4000K/6000K	White	24°/36°
LLF300C	12W	Bridglux C8	≥90	961.94Lm	3000K/4000K/6000K	White	24°/36°
LLF300D	24W	Bridglux C8	≥90	1799.65Lm	3000K/4000K/6000K	White	24°/36°

### PRODUCT DIMENSION

Unit(mm)

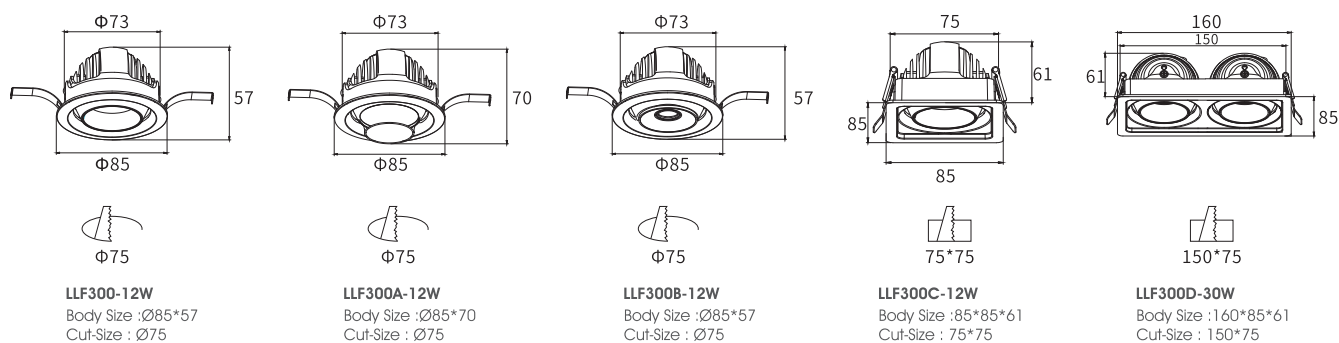

# LED COB DOWN LIGHT SERIES

A small figure  
Light up the colorful world

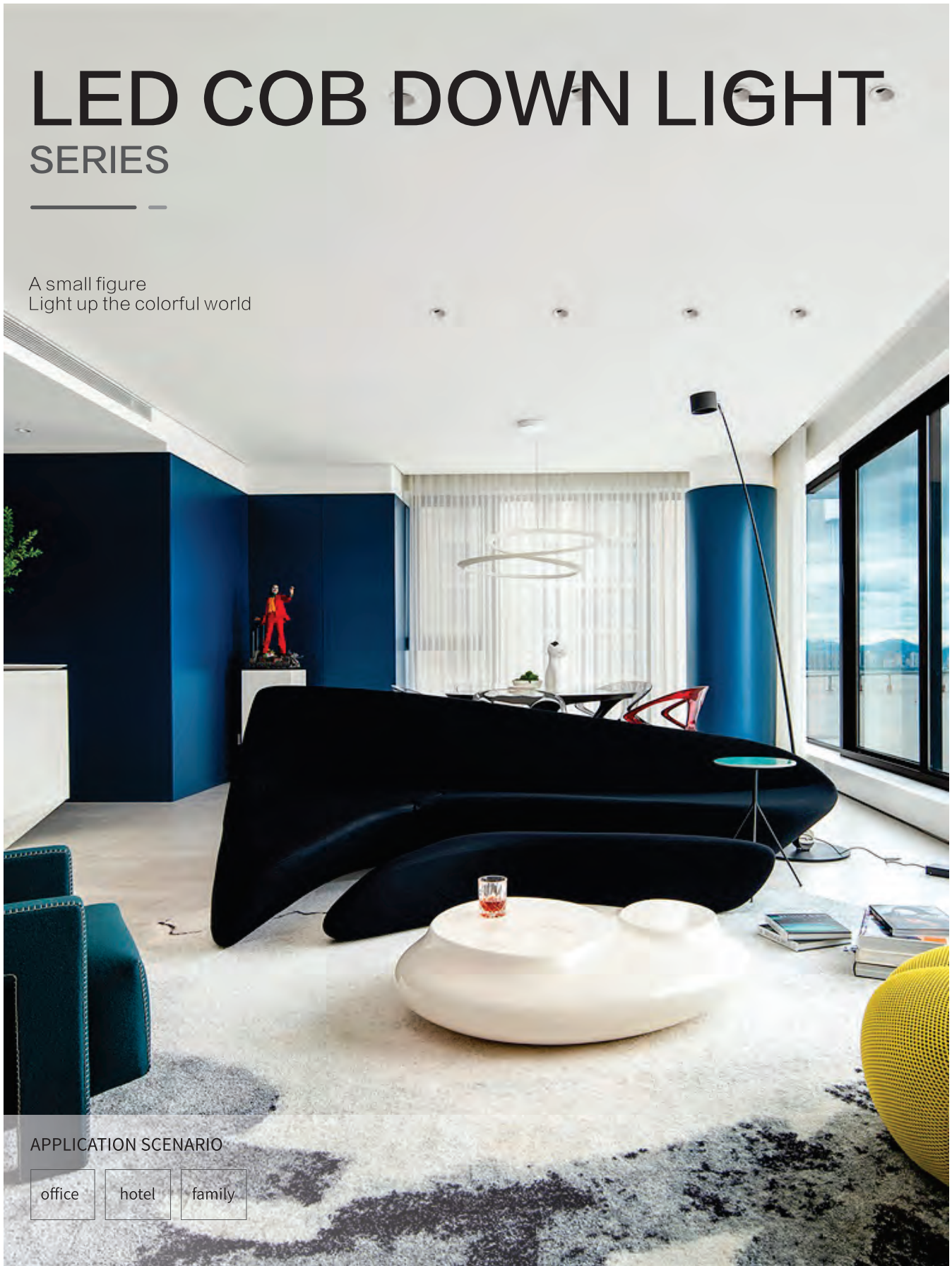

## APPLICATION SCENARIO

office

hotel

family

## LED COB DOWN LIGHT SERIES

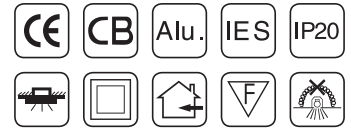

### PRODUCT PARAMETERS



Model No.	Power	LED Chip	CRI	Lumens	CCT	Body Color	Beam Angle
LLF301	3W	CREE	≥90	255Lm	3000K/4000K/5000K/ 6000K	White / Black	38°
LLF302	7W	CREE	≥90	595Lm	3000K/4000K/5000K/ 6000K	White / Black	38°
LLF303	12W	CREE	≥90	1020Lm	3000K/4000K/5000K/ 6000K	White / Black	38°
LLF304	20W	CREE	≥90	1700Lm	3000K/4000K/5000K/ 6000K	White / Black	38°
LLF305	30W	CREE	≥90	1740Lm	3000K/4000K/5000K/ 6000K	White / Black	38°

### PRODUCT DIMENSION

Unit(mm)

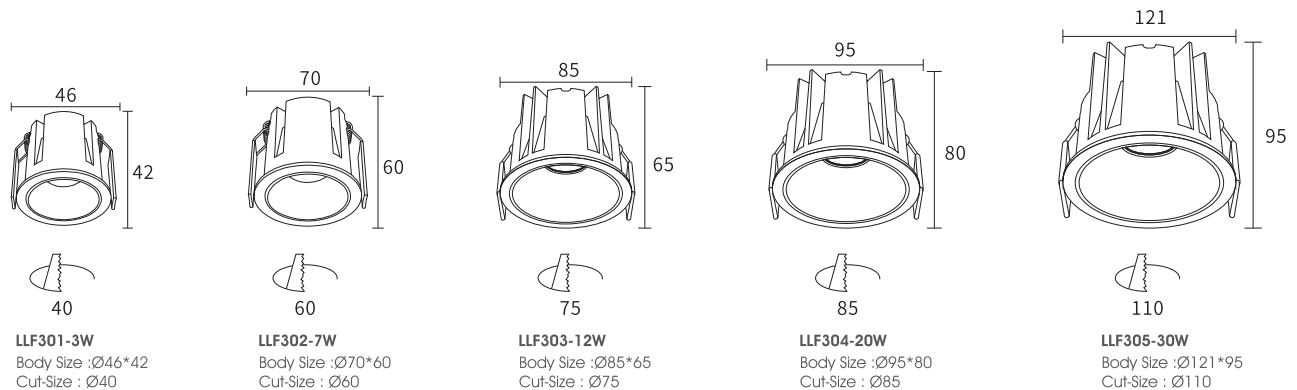



# LED COB/SMD WITH DIFFUSER DOWN LIGHT SERIES

High rendering Color index  
Restore True Colors



## APPLICATION SCENARIO

office

hotel

family

## LED COB/SMD WITH DIFFUSER DOWN LIGHT SERIES

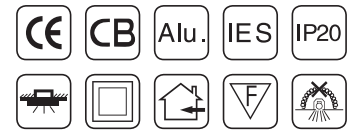

LLF-306A/LLF-306



LLF-308A/LLF-308



LLF-307A/LLF-307

### PRODUCT PARAMETERS



Model No.	Power	LED Chip	CRI	Lumens	CCT	Body Color	Beam Angle
LLF306A	7W	SMD	≥90	595Lm	3000K/4000K/5000K/6000K/AdjustRF2.4G	White / Gun Black	90°
LLF307A	12W	SMD	≥90	1020Lm	3000K/4000K/5000K/6000K/AdjustRF2.4G	White / Gun Black	90°
LLF308A	18W	SMD	≥90	1530Lm	3000K/4000K/5000K/6000K/AdjustRF2.4G	White / Gun Black	90°
LLF306	7W	COB	≥90	595Lm	3000K/4000K/5000K/6000K/AdjustRF2.4G	White / Gun Black	120°
LLF307	12W	COB	≥90	1020Lm	3000K/4000K/5000K/6000K/AdjustRF2.4G	White / Gun Black	120°
LLF308	18W	COB	≥90	1530Lm	3000K/4000K/5000K/6000K/AdjustRF2.4G	White / Gun Black	120°

### PRODUCT DIMENSION

Unit(mm)

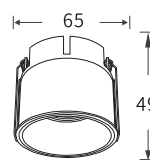

LLF306A / LLF306-7W  
Body Size :Ø65\*49  
Cut-Size : Ø60

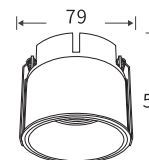

LLF307A / LLF307-12W  
Body Size :Ø79\*59  
Cut-Size : Ø75

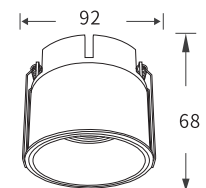

LLF308A / LLF308-18W  
Body Size :Ø92\*68  
Cut-Size : Ø85



# LED COB DOWN LIGHT SERIES

---

Three color temperatures, three watts  
Three beam angles



## APPLICATION SCENARIO

office

hotel

family

LED COB DOWN LIGHT  
SERIES

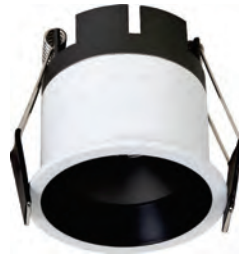
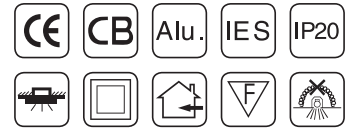

LLF309



LLF311



LLF310

PRODUCT PARAMETERS



Model No.	Power	LED Chip	CRI	Lumens	CCT	Body Color	Beam Angle
LLF309	8W	CREE	≥90	637.6Lm	3000K/4000K/6000K	White	20°/40°/60°
LLF310	15W	CREE	≥90	1096Lm	3000K/4000K/6000K	White	20°/40°/60°
LLF311	20W	CREE	≥90	1317Lm	3000K/4000K/6000K	White	20°/40°/60°

PRODUCT DIMENSION

Unit(mm)

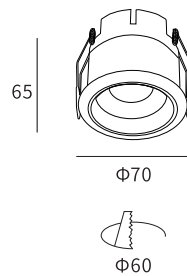

LLF309-8W  
Body Size : $\varnothing$ 70\*65  
Cut-Size :  $\varnothing$ 60

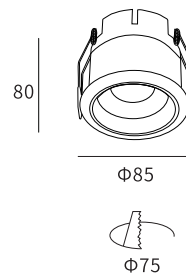

LLF310-15W  
Body Size : $\varnothing$ 80\*85  
Cut-Size :  $\varnothing$ 75

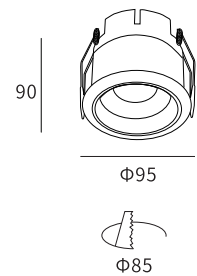

LLF311-20W  
Body Size : $\varnothing$ 95\*90  
Cut-Size :  $\varnothing$ 85

# LED COB MODULAR FIXTURES SERIES

High rendering Color index  
Restore True Colors



APPLICATION SCENARIO

office

family

## LED COB MODULAR FIXTURES SERIES

ONE BODY DIFFERENT ATTACHMENTS

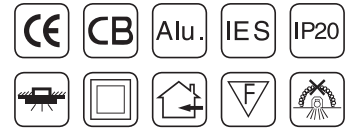

LLF315A



LLF315B



LLF315C

### PRODUCT PARAMETERS



Model No.	Power	LED Chip	CRI	Lumens	CCT	Body Color	Beam Angle
LLF315A	10W	CREE	≥90	750lm	3000K/4000K/5700K	White / Black	36°/50°
LLF315B	10W	CREE	≥90	750lm	3000K/4000K/5700K	White / Black	36°/50°
LLF315C	10W	CREE	≥90	750lm	3000K/4000K/5700K	White / Black	36°/50°

### PRODUCT DIMENSION

Unit(mm)

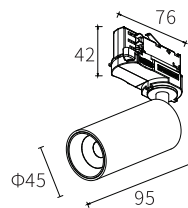

LLF315A-10W  
Body Size :Ø45\*95

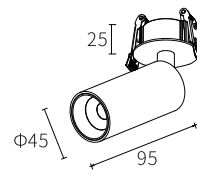

LLF315B-10W  
Body Size :Ø45\*95  
Cut-Size : Ø20

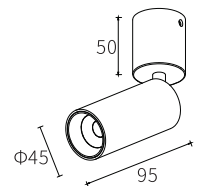

LLF315C-10W  
Body Size :Ø45\*95

**LED COB MODULAR FIXTURES SERIES**

ONE BODY DIFFERENT ATTACHMENTS

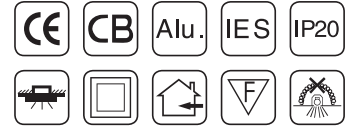

LLF316



LLF316A



LLF316B



LLF316C



LLF316D

**PRODUCT PARAMETERS**



Model No.	Power	LED Chip	CRI	Lumens	CCT	Body Color	Beam Angle
LLF316	15W	CREE	≥90	1125Lm	3000K/4000K/5700K	White / Black	36°/50°
LLF316A	15W	CREE	≥90	1125Lm	3000K/4000K/5700K	White / Black	36°/50°
LLF316B	15W	CREE	≥90	1125Lm	3000K/4000K/5700K	White / Black	36°/50°
LLF316C	15W	CREE	≥90	1125Lm	3000K/4000K/5700K	White / Black	36°/50°
LLF316D	15W	CREE	≥90	1125Lm	3000K/4000K/5700K	White / Black	36°/50°

**PRODUCT DIMENSION**

Unit(mm)

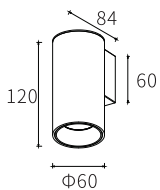

LLF316-15W  
Body Size :Ø60\*120

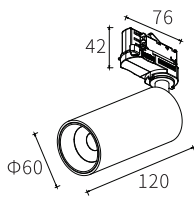

LLF316A-15W  
Body Size :Ø60\*120

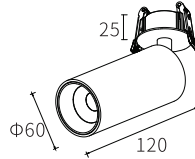

LLF316B-15W  
Body Size :Ø60\*120  
Cut-Size : Ø50

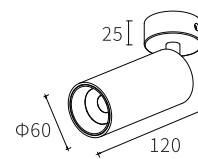

LLF316C-15W  
Body Size :Ø60\*120

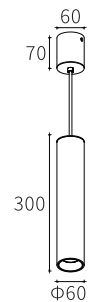

LLF316D-15W  
Body Size :Ø60\*300





# LED COB DOWN LIGHT SERIES

Familiarization design  
Choose freely



#### APPLICATION SCENARIO

office

hotel

family

## LED COB DOWN LIGHT SERIES

FRONT SERVICEABLE



LLF319



LLF320



LLF321

### PRODUCT PARAMETERS



Model No.	Power	LED Chip	CRI	Lumens	CCT	Body Color	Beam Angle
LLF319	9W	CREE	≥90	470Lm	2700K/3000K/4000K/5000K	White	36°
LLF320	12W	CREE	≥90	738Lm	2700K/3000K/4000K/5000K	White	36°
LLF321	20W	CREE	≥90	1230Lm	2700K/3000K/4000K/5000K	White	36°

### PRODUCT DIMENSION

Unit(mm)

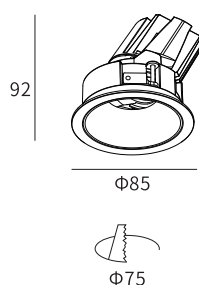

**LLF319-9W**  
Body Size : Ø85\*92  
Cut-Size : Ø75

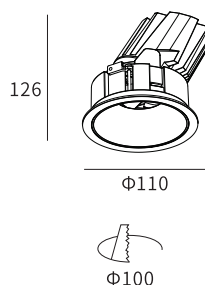

**LLF320-12W**  
Body Size : Ø110\*126  
Cut-Size : Ø100

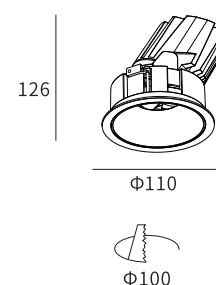

**LLF321-20W**  
Body Size : Ø110\*126  
Cut-Size : Ø100

**LED COB DOWN LIGHT SERIES**

FRONT SERVICEABLE

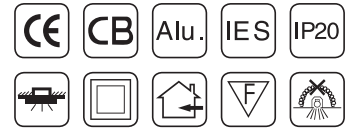

**PRODUCT PARAMETERS**



Model No.	Power	LED Chip	CRI	Lumens	CCT	Body Color	Beam Angle
LLF322	7W	CREE	≥90	246Lm	2700K/3000K/4000K/5000K	White / Black	15°/24°/36°
LLF322A RIMLESS	7W	CREE	≥90	246Lm	2700K/3000K/4000K/5000K	White / Black	15°/24°/36°
LLF323	12W	CREE	≥90	516Lm	2700K/3000K/4000K/5000K	White / Black	15°/24°/36°
LLF323A RIMLESS	12W	CREE	≥90	516Lm	2700K/3000K/4000K/5000K	White / Black	15°/24°/36°
LLF324	20W	CREE	≥90	64Lm/W	2700K/3000K/4000K/5000K	White / Black	15°/24°/36°

**PRODUCT DIMENSION**

Unit(mm)

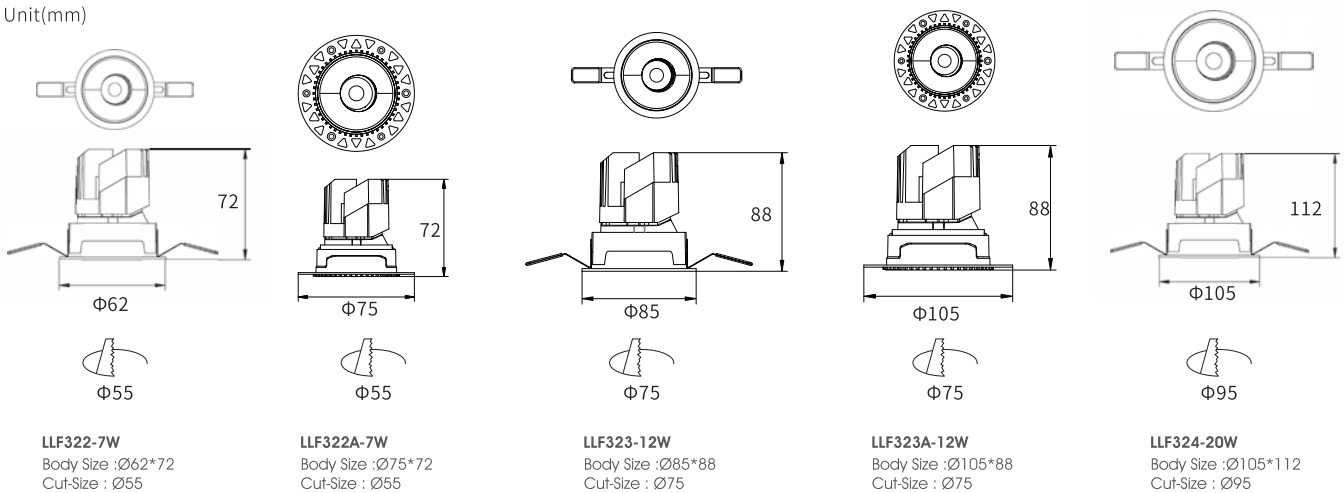

## LED COB DOWN LIGHT SERIES

FRONT SERVICEABLE

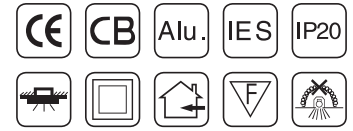

LLF323B



LLF323C  
RIMLESS



LLF323D



LLF323E  
RIMLESS

### PRODUCT PARAMETERS



Model No.	Power	LED Chip	CRI	Lumens	CCT	Body Color	Beam Angle
LLF323B	12W	CREE	≥90	516Lm	2700K/3000K/4000K/5000K	White / Black	15°/24°/36°
LLF323D	12W	CREE	≥90	516*2Lm	2700K/3000K/4000K/5000K	White / Black	15°/24°/36°
LLF323C RIMLESS	12W	CREE	≥90	516Lm	2700K/3000K/4000K/5000K	White / Black	15°/24°/36°
LLF323E RIMLESS	24W	CREE	≥90	516*2Lm	2700K/3000K/4000K/5000K	White / Black	15°/24°/36°

### PRODUCT DIMENSION

Unit(mm)

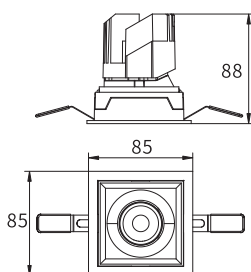

75\*75

**LLF323B-12W**  
Body Size :85\*85\*88  
Cut-Size : 75\*75

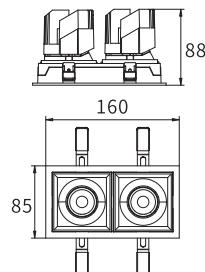

145\*75

**LLF323D RIMLESS-12W**  
Body Size :160\*85\*88  
Cut-Size : 145\*75

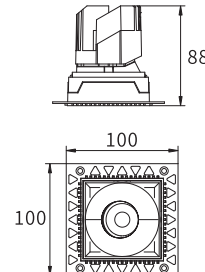

Φ75

**LLF323C-12W**  
Body Size :100\*100\*88  
Cut-Size : 75\*75

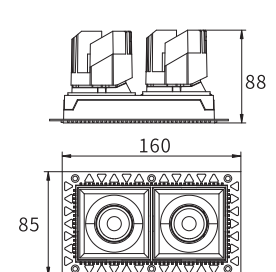

145\*75

**LLF323E RIMLESS-24W**  
Body Size :160\*85\*88  
Cut-Size : 145\*75



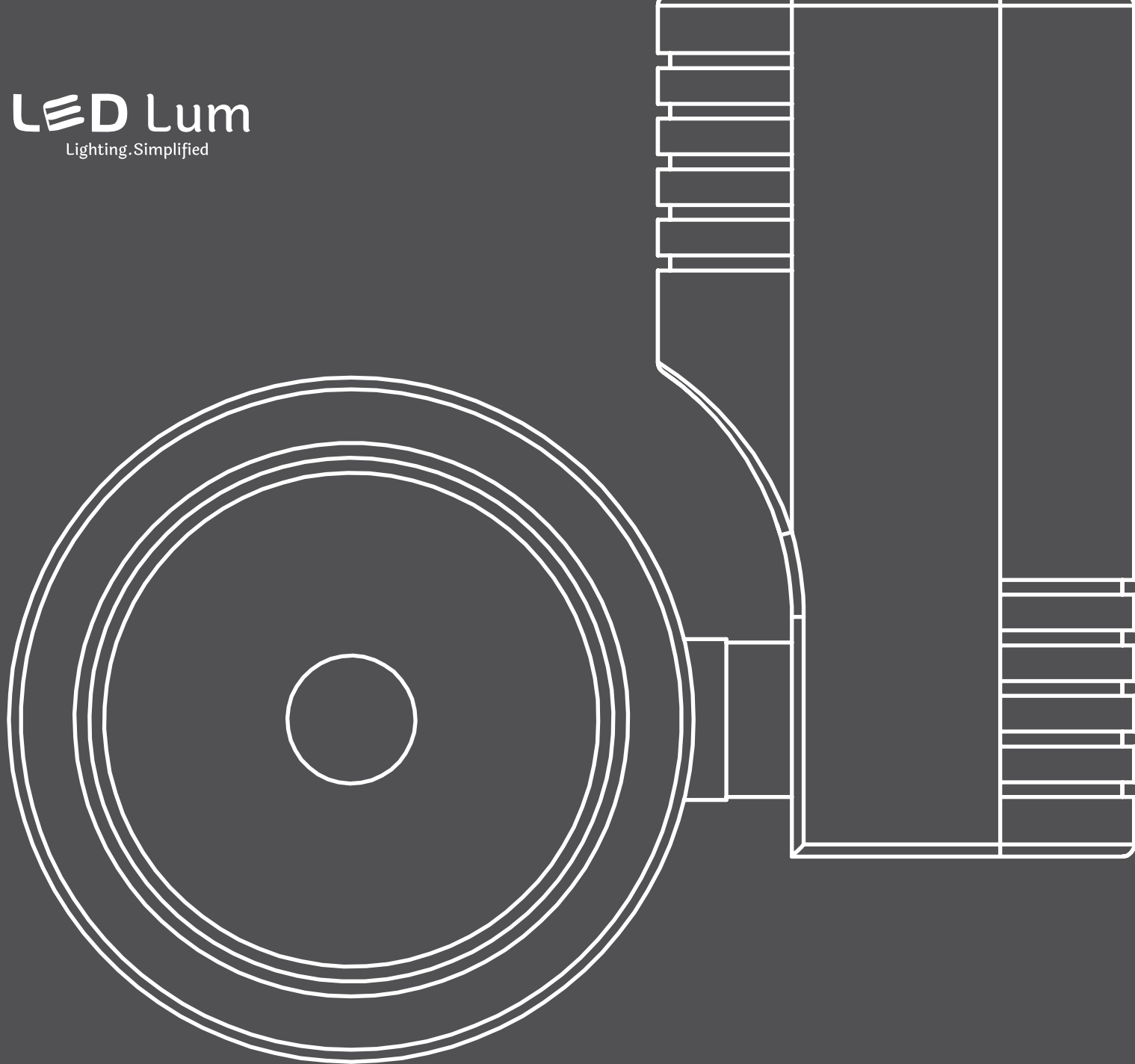

# INDOOR LED LIGHTING

---

TRACK LIGHT SERIES



#### APPLICATION OF LED TRACK LIGHT

Track light is installed in a similar track above the lamp, you can adjust the irradiation angle, generally used as a spotlight in the need to focus on lighting.

Track lights are generally used as a specific spotlight, General merchandise majority, such as shopping malls (clothing stores, furniture stores and other brand stores), car show, jewelry, star hotels, brand clothing, high-end clubs, cultural relics exhibition hall, chain stores, brand business hall, And other key lighting places.



## LED TRACK LIGHT SERIES



**CAN BE MADE TO ORDER**  
DIMMABLE/TUNABLE WITH RF CONTROL

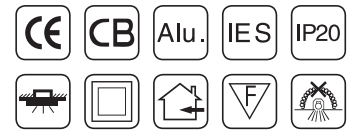

**PRODUCT PARAMETERS**

**EPISTAR**

Model No.	Power	LED Chip	CRI	Lumens	CCT	Body Color	Beam Angle
LLF149	10W	EPISTAR COB	≥ 80	800Lm	3000K/4000K/6000K	White	64°
LLF150	20W	EPISTAR COB	≥ 80	1600Lm	3000K/4000K/6000K	White	40°
LLF151	30W	EPISTAR COB	≥ 80	2400Lm	3000K/4000K/6000K	White	30°

**PRODUCT DIMENSION**

Unit (mm)

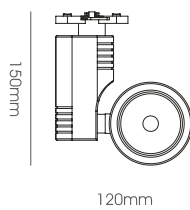

**LLF149-10W**  
Body Size:  
Ø80\*120\*150mm

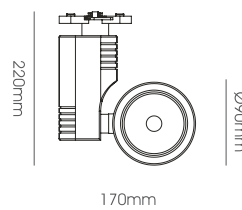

**LLF150-20W**  
Body Size:  
Ø90\*170\*220mm

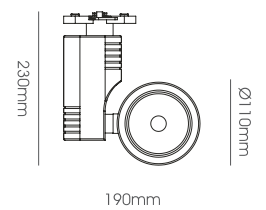

**LLF151-30W**  
Body Size:  
Ø110\*190\*230mm

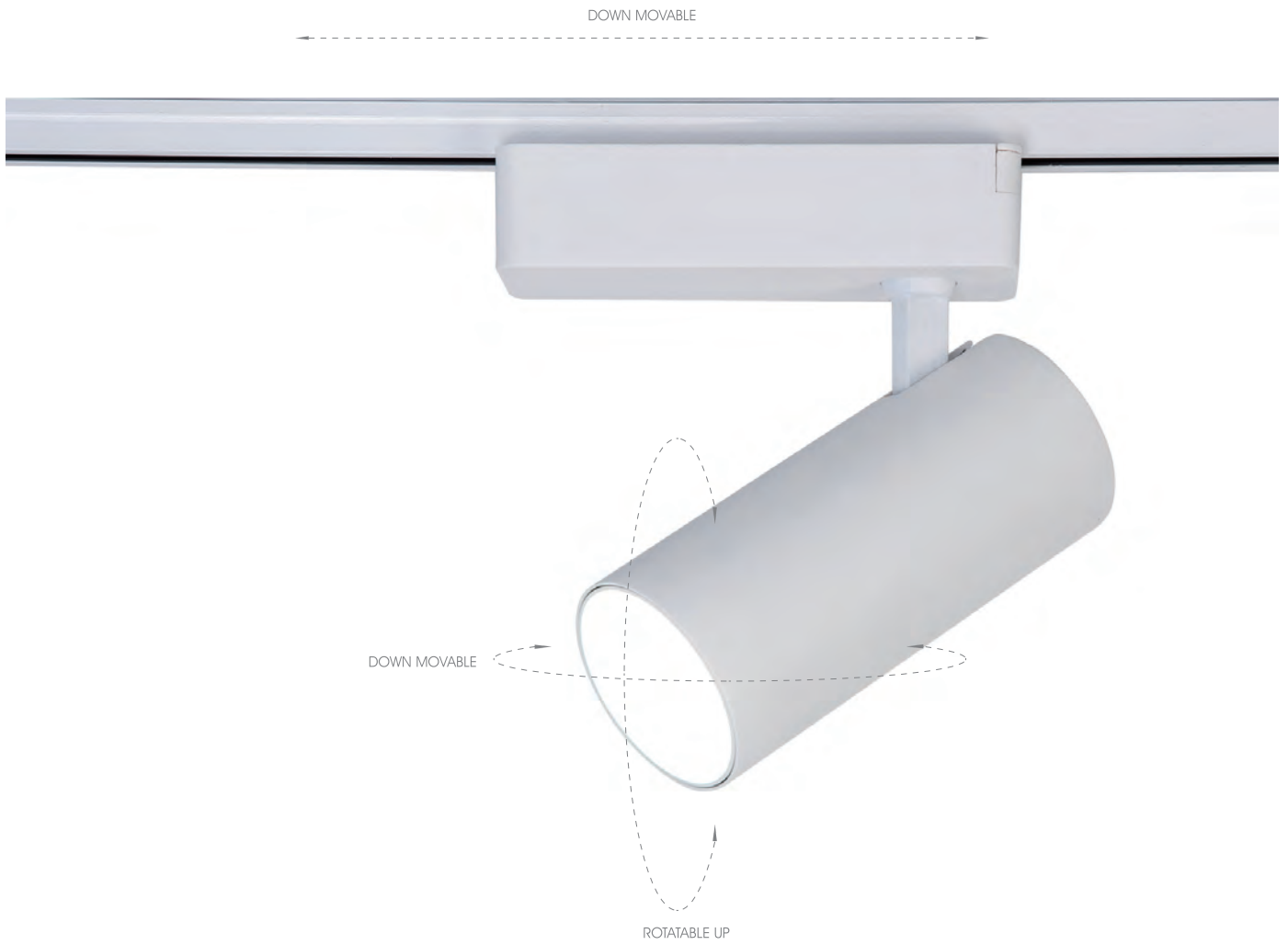



**CAN BE MADE TO ORDER**  
DIMMABLE/TUNABLE WITH RF CONTROL



**PRODUCT PARAMETERS**



Model No.	Power	LED Chip	CRI	Lumens	CCT	Body Color	Beam Angle
LLF156	10W	BRIDGELUX COB	≥80	80Lm/W	3000K/4000K/6000K	White / Black	38°
LLF157	20W	BRIDGELUX COB	≥80	80Lm/W	3000K/4000K/6000K	White / Black	38°
LLF158	30W	BRIDGELUX COB	≥80	80Lm/W	3000K/4000K/6000K	White / Black	38°
LLF159	40W	BRIDGELUX COB	≥80	80Lm/W	3000K/4000K/6000K	White / Black	38°

**PRODUCT DIMENSION**

Unit (mm)

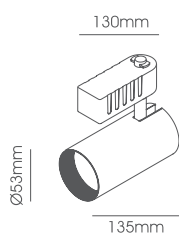

**LLF156-10W**  
Body Size:  
Ø53\*135\*140mm

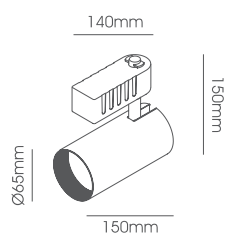

**LLF157-20W**  
Body Size:  
Ø65\*150\*150mm

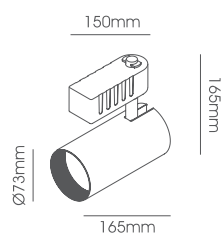

**LLF158-30W**  
Body Size:  
Ø73\*165\*165mm

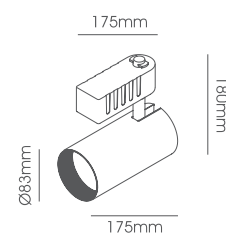

**LLF159-40W**  
Body Size:  
Ø83\*175\*180mm

**CAN BE MADE TO ORDER**  
DIMMABLE/TUNABLE WITH RF CONTROL

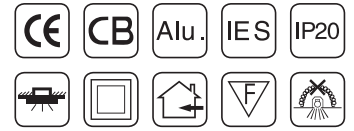

LLF159A/LLF159B

LLF159E/LLF159F

**PRODUCT PARAMETERS**



Model No.	Power	LED Chip	CRI	Lumens	CCT	Body Color	Beam Angle
LLF159A	6W	BRIDGELUX COB	≥90	430-535Lm	3000K/4000K/6000K	White / Black	36°
LLF159B	10W	BRIDGELUX COB	≥90	670-770Lm	3000K/4000K/6000K	White / Black	36°
LLF159E	20W	BRIDGELUX COB	≥90	80Lm/W	3000K/4000K/6000K	White / Black	60°
LLF159F	30W	BRIDGELUX COB	≥90	80Lm/W	3000K/4000K/6000K	White / Black	60°

**PRODUCT DIMENSION**

Unit (mm)

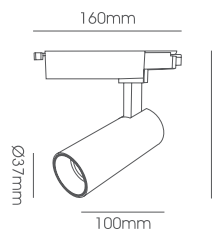

**LLF159A-6W**  
Body Size:  
Ø37\*100\*125\*160mm

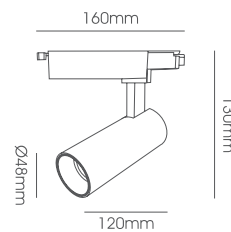

**LLF159B-10W**  
Body Size:  
Ø48\*120\*130\*160mm

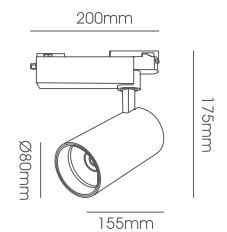

**LLF159E/F-20/30W**  
Body Size:  
Ø80\*155\*175\*200mm



PRODUCT PARAMETERS



Model No.	Power	LED Chip	CRI	Lumens	CCT	Body Color	Beam Angle
LLF223	3W	BRIDGELUX COB	≥80	240Lm	3000K/4000K	White / Black	24° (Shinland)
LLF224	6W	BRIDGELUX COB	≥80	480Lm	3000K/4000K	White / Black	40° (Shinland)
LLF225	12W	BRIDGELUX COB	≥80	960Lm	3000K/4000K	White / Black	38° (Shinland)

PRODUCT DIMENSION

nit (mm)

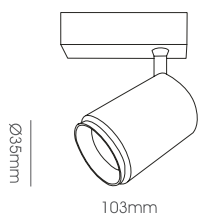

LLF223-3W  
Body Size:  
Ø35\*103\*88mm

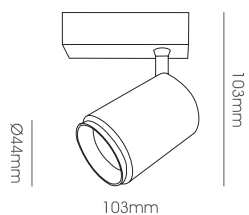

LLF224-6W  
Body Size:  
Ø44\*103\*103mm

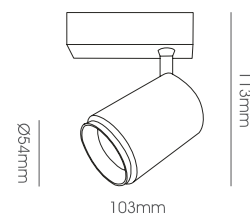

LLF225-12W  
Body Size:  
Ø54\*103\*113mm



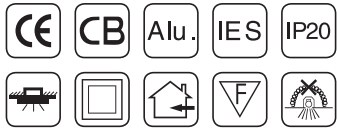

Sand White

Sand Black

Sand Silver

Rose Gold

All Copper

PRODUCT PARAMETERS



Model No.	Power	LED Chip	CRI	Lumens	CCT	Body Color	Beam Angle
LLF277	6W	OSRAM 1202 COB	≥90	420-555Lm	3000K/4000K	White / Black / Rose Gold / Bronze	36°

PRODUCT DIMENSION

Unit (mm)

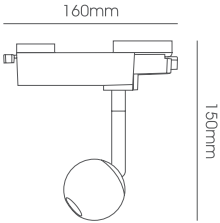

LLF277-6W  
Body Size:  
160\*150mm



# PROJECT RETAIL LIGHTING COB DOWN LIGHTER'S/TRACKS SERIES

High rendering Color index  
Restore True Colors



## APPLICATION SCENARIO

office

hotel

family

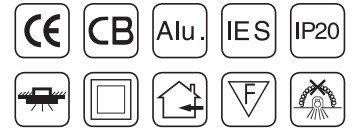

**PRODUCT PARAMETERS**

Model No.	Power	LED Chip	CRI	Lumens	CCT	Body Color	Beam Angle
LLF325	25W	/	≥90	90Lm/W	3000K/4000K/6000K	White / Black	24°/36°
LLF326	35W	/	≥90	90Lm/W	3000K/4000K/6000K	White / Black	24°/36°
LLF327	25W	/	≥90	90Lm/W	3000K/4000K/6000K	White / Black	24°/36°
LLF328	35W	/	≥90	90Lm/W	3000K/4000K/6000K	White / Black	24°/36°

**PRODUCT DIMENSION**

Unit(mm)

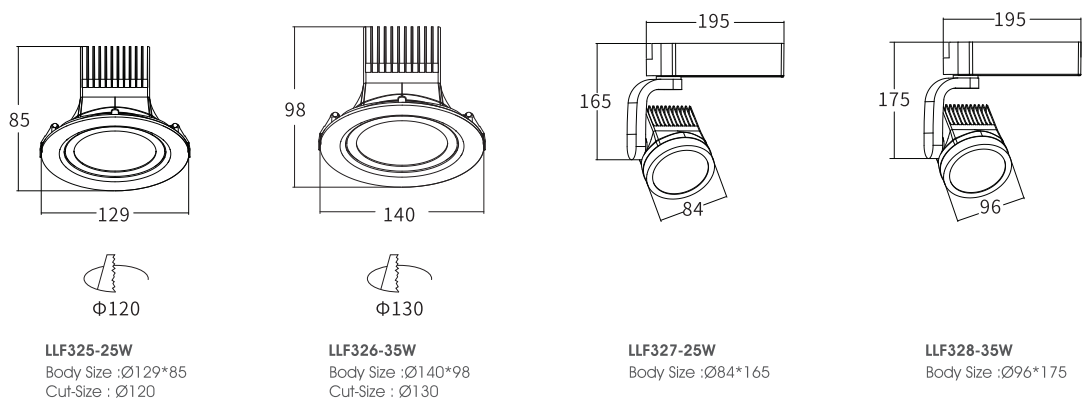

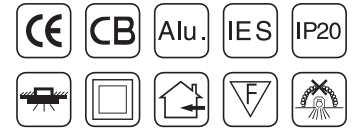

LLF329



LLF330



LLF331



LLF332

**PRODUCT PARAMETERS**

Model No.	Power	LED Chip	CRI	Lumens	CCT	Body Color	Beam Angle
LLF329	7W	/	≥90	630Lm	3000K/4000K/6000K	White	90°
LLF330	12W	/	≥90	1080Lm	3000K/4000K/6000K	White	90°
LLF331	20W	/	≥90	1800Lm	3000K/4000K/6000K	White	90°
LLF332	30W	/	≥90	2700Lm	3000K/4000K/6000K	White	90°

**PRODUCT DIMENSION**

Unit(mm)

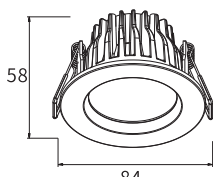

**LLF329-7W**  
Body Size :Ø84\*58  
Cut-Size : Ø75

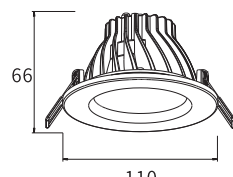

**LLF330-12W**  
Body Size :Ø110\*66  
Cut-Size : Ø100

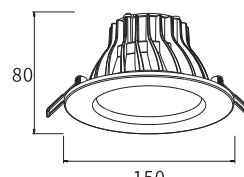

**LLF331-20W**  
Body Size :Ø150\*80  
Cut-Size : Ø120

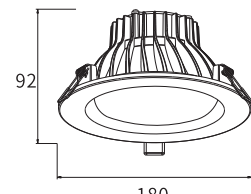

**LLF332-30W**  
Body Size :Ø180\*92  
Cut-Size : Ø165

PROJECT/RETAIL LIGHTING  
LED COB DOWN LIGHTER'S  
SERIES

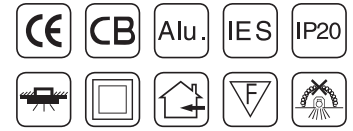

PRODUCT PARAMETERS

Model No.	Power	LED Chip	CRI	Lumens	CCT	Body Color	Beam Angle
LLF333	7W	/	≥90	630Lm	4000K	White	90°
LLF334	12W	/	≥90	1080Lm	4000K	White	90°
LLF335	20W	/	≥90	1800Lm	4000K	White	90°
LLF336	30W	/	≥90	2700Lm	4000K	White	90°

PRODUCT DIMENSION

Unit(mm)

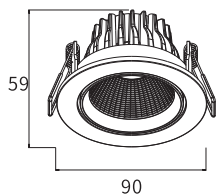

LLF333-7W  
Body Size : Ø90\*59  
Cut-Size : Ø75

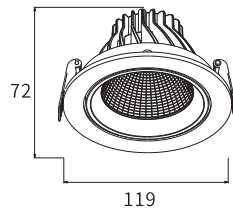

LLF334-12W  
Body Size : Ø110\*72  
Cut-Size : Ø100

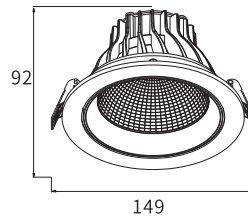

LLF335-20W  
Body Size : Ø150\*92  
Cut-Size : Ø120

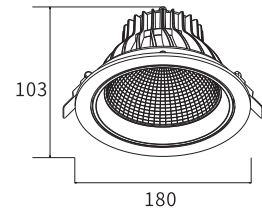

LLF336-30W  
Body Size : Ø180\*103  
Cut-Size : Ø165



# LED – INDOOR FOOT LIGHT SERIES

---

Multiple colors  
paired with different home styles





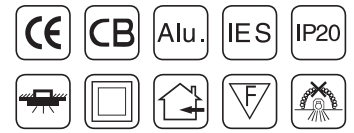

PRODUCT PARAMETERS



Model No.	Power	LED Chip	CRI	Lumens	CCT	Body Color	Beam Angle
LLF160	1W	BRIDGELUX SMD	≥80	80Lm/W	3000K	White	60°
LLF161	1W	BRIDGELUX SMD	≥80	80Lm/W	3000K	White	60°
LLF162	1W	BRIDGELUX SMD	≥80	80Lm/W	3000K	White	60°
LLF163	1*3W	BRIDGELUX SMD	≥80	80Lm/W	3000K	White	60°
LLF164	1*3W	BRIDGELUX SMD	≥80	80Lm/W	3000K	White	60°
LLF166	3*1W	BRIDGELUX SMD	≥80	80Lm/W	3000K	Grey	90°

PRODUCT DIMENSION

Unit (mm)

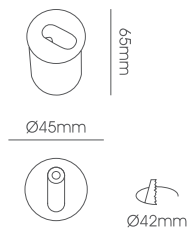

**LLF160-1W**  
Body Size: 45\*65mm  
Cut-Size: 42mm

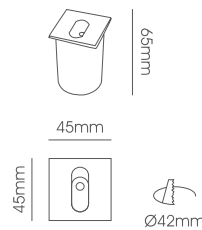

**LLF161-1W**  
Body Size: 45\*65mm  
Cut-Size: 42mm

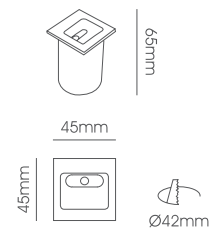

**LLF162-1W**  
Body Size: 45\*65mm  
Cut-Size: 42mm

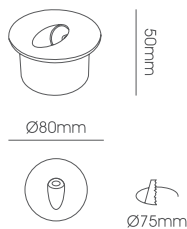

**LLF163-1\*3W**  
Body Size: 80\*50mm  
Cut-Size: 75mm

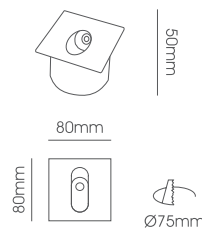

**LLF164-1\*3W**  
Body Size: 80\*50mm  
Cut-Size: 75mm

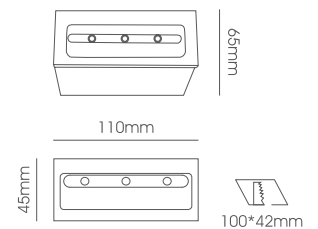

**LLF166-3\*1W**  
Body Size: 110\*45\*65mm  
Cut-Size: 100\*42mm

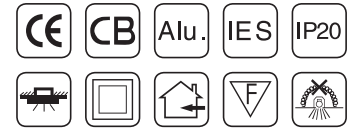

LFO 011



LFO 013



LFO 012



LFO 014

**PRODUCT PARAMETERS**



Model No.	Power	LED Chip	CRI	Lumens	CCT	Body Color	Beam Angle
LFO 011	3W	OSRAM 3030	≥80	/	3000K	Sandy White / Sandy Black	FLOOD
LFO 012	3W	OSRAM 3030	≥80	/	3000K	Sandy White / Sandy Black	FLOOD
LFO 013	3W	OSRAM 3030	≥80	/	3000K	Sandy White / Sandy Black	FLOOD
LFO 014	3W	OSRAM 3030	≥80	/	3000K	Sandy White / Sandy Black	FLOOD

**PRODUCT DIMENSION**

Unit(mm)

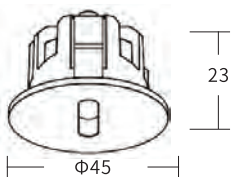

**LFO 011-3W**  
Body Size : $\varnothing 45 \times 23$   
Cut-Size :  $\varnothing 35$

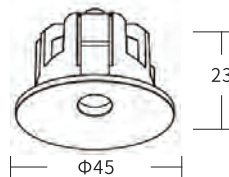

**LFO 012-3W**  
Body Size : $\varnothing 45 \times 23$   
Cut-Size :  $\varnothing 35$

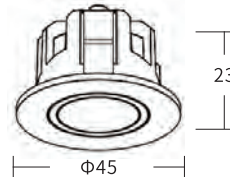

**LFO 013-3W**  
Body Size : $\varnothing 45 \times 23$   
Cut-Size :  $\varnothing 35$

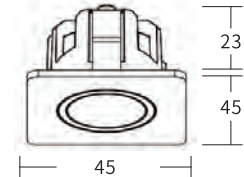

**LFO 014-3W**  
Body Size : $45 \times 45 \times 23$   
Cut-Size :  $\varnothing 35$

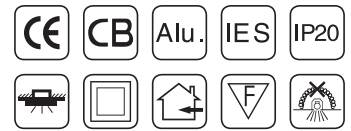

LFO 015



LFO 016



LFO 017

PRODUCT PARAMETERS



Model No.	Power	LED Chip	CRI	Lumens	CCT	Body Color	Beam Angle
LFO 015	3W	OSRAM 3030	≥80	/	3000K	Sandy White / Sandy Black	FLOOD
LFO 016	3W	OSRAM 3030	≥80	/	3000K	Sandy White / Sandy Black	FLOOD
LFO 017	3W	OSRAM 3030	≥80	/	3000K	Sandy White / Sandy Black	FLOOD

PRODUCT DIMENSION

Unit(mm)

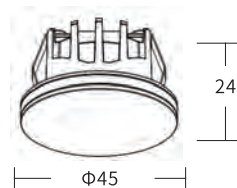

LFO 015-3W  
Body Size :Ø45\*27  
Cut-Size : Ø35

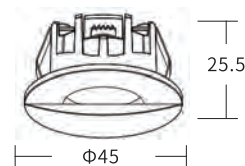

LFO 016-3W  
Body Size :Ø45\*25.5  
Cut-Size : Ø35

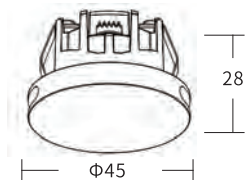

LFO 017-3W  
Body Size :Ø45\*28  
Cut-Size : Ø35

# INDOOR LED LIGHTING

---

DOWN LIGHT SERIES



#### APPLICATION OF LED DOWN LIGHT

In the traditional way Gathered time flow of sound a snowflake, drifting to the depths of the season winter sunshine, sowing warm light extending rivers and lakes of the rushing and vast melted by the idea of the ice as well as creatures to express the tenderness of the ice warm red let the world be filled with warmth



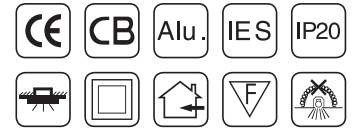

**PRODUCT PARAMETERS**



Model No.	Power	LED Chip	CRI	Lumens	CCT	Body Color	Beam Angle
LLF001	8W	SANAN SMD	≥80	90-100lm/W	3000K/4000K/6000K	White	160°
LLF002	15W	SANAN SMD	≥80	90-100lm/W	3000K/4000K/6000K	White	160°
LLF003	22W	SANAN SMD	≥80	90-100lm/W	3000K/4000K/6000K	White	160°

**PRODUCT DIMENSION**

Unit (mm)



Ø104mm



**LLF001-8W**  
Body Size: Ø104\*41mm  
Cut-Size: Ø90mm



Ø157mm



**LLF002-15W**  
Body Size: Ø157\*41mm  
Cut-Size: Ø145mm



Ø184mm



**LLF003-22W**  
Body Size: Ø184\*41mm  
Cut-Size: Ø175mm

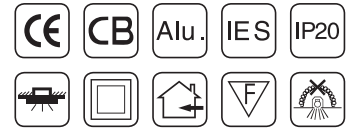

LLF006

LLF004



LLF005

## PRODUCT PARAMETERS



Model No.	Power	LED Chip	CRI	Lumens	CCT	Body Color	Beam Angle
LLF004	8W	SANAN SMD	≥80	90-100lm/W	3000K/4000K/6000K	White	160°
LLF005	15W	SANAN SMD	≥80	90-100lm/W	3000K/4000K/6000K	White	160°
LLF006	22W	SANAN SMD	≥80	90-100lm/W	3000K/4000K/6000K	White	160°

## PRODUCT DIMENSION

Unit (mm)

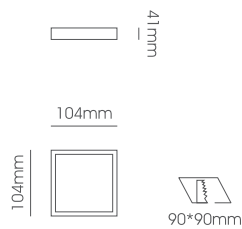

**LLF004-8W**  
Body Size: 104\*104\*41mm  
Cut-Size: 90\*90mm

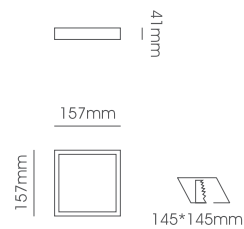

**LLF005-15W**  
Body Size: 157\*157\*41mm  
Cut-Size: 145\*145mm

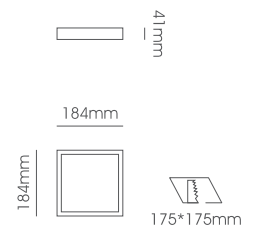

**LLF006-22W**  
Body Size: 184\*184\*41mm  
Cut-Size: 175\*175mm

**CAN BE MADE TO ORDER**  
DIMMABLE/TUNABLE WITH RF CONTROL

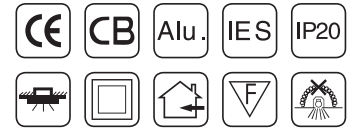

**PRODUCT PARAMETERS**



Model No.	Power	LED Chip	CRI	Lumens	CCT	Body Color	Beam Angle
LLF058	12W	OSRAM SMD	≥80	1140Lm	3000K/4000K/6000K	White / Black	120°
LLF058A	18W	OSRAM SMD	≥80	1710Lm	3000K/4000K/6000K	White / Black	120°
LLF058B	24W	OSRAM SMD	≥80	2280Lm	3000K/4000K/6000K	White / Black	120°

**PRODUCT DIMENSION**

Unit (mm)

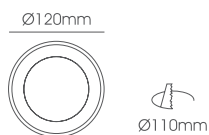

**LLF058-12W**  
Body Size: Ø120\*55mm  
Cut-Size: Ø110mm

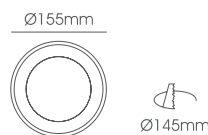

**LLF058A-18W**  
Body Size: Ø155\*65mm  
Cut-Size: Ø145mm

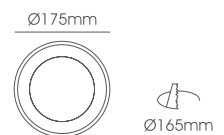

**LLF058B-24W**  
Body Size: Ø175\*65mm  
Cut-Size: Ø165mm

JUNCTION BOX LIGHTS

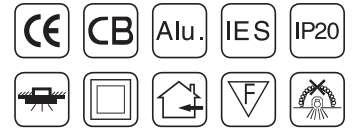

PRODUCT PARAMETERS



Model No.	Power	LED Chip	CRI	Lumens	CCT	Body Color	Beam Angle
LLF035A	3W	BRIDGELUX COB	≥80	280-300Lm	3000K/4000K/6000K/ RED/GREEN/BLUE/PINK	White	180°

PRODUCT DIMENSION

Unit (mm)

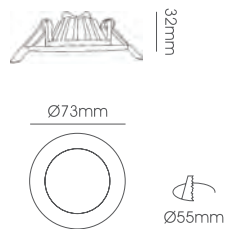

**LLF035A-3W**  
Body Size: Ø73\*32mm  
Cut-Size: Ø55mm

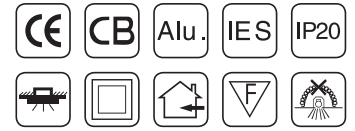

**PRODUCT PARAMETERS**

**EPISTAR**

Model No.	Power	LED Chip	CRI	Lumens	CCT	Body Color	Beam Angle
LLF007	4W	EPISTAR SMD	≥80	220Lm	3000K/4000K/6000K	White	120°
LLF008	9W	EPISTAR SMD	≥80	675Lm	3000K/4000K/6000K	White	120°
LLF009	12W	EPISTAR SMD	≥80	1020Lm	3000K/4000K/6000K	White	120°
LLF010A	18W	EPISTAR SMD	≥80	1530Lm	3000K/4000K/6000K	White	120°
LLF010	22W	EPISTAR SMD	≥80	1870Lm	3000K/4000K/6000K	White	120°
LLF011	30W	EPISTAR SMD	≥80	2550Lm	3000K/4000K/6000K	White	120°

**PRODUCT DIMENSION**

Unit (mm)

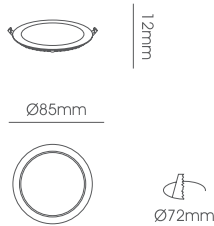

**LLF007-4W**  
Body Size: Ø85\*12mm  
Cut-Size: Ø72mm

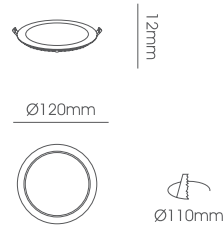

**LLF008-9W**  
Body Size: Ø120\*12mm  
Cut-Size: Ø110mm

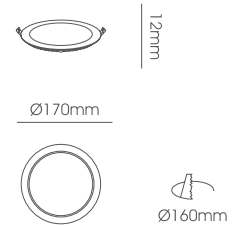

**LLF009-12W**  
Body Size: Ø170\*12mm  
Cut-Size: Ø160mm

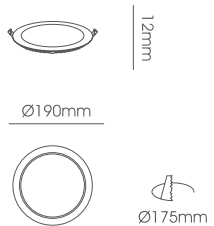

**LLF010A-18W**  
Body Size: Ø190\*12mm  
Cut-Size: Ø175mm

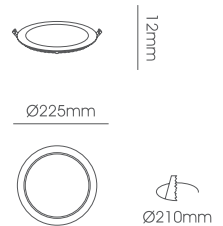

**LLF010-22W**  
Body Size: Ø225\*12mm  
Cut-Size: Ø210mm

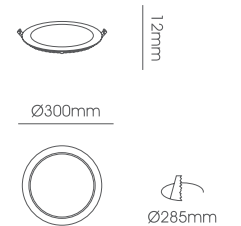

**LLF011-30W**  
Body Size: Ø300\*12mm  
Cut-Size: Ø285mm



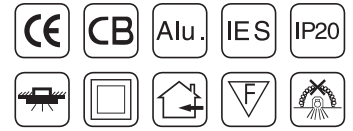

PRODUCT PARAMETERS

EPISTAR

Model No.	Power	LED Chip	CRI	Lumens	CCT	Body Color	Beam Angle
LLF012	4W	EPISTAR SMD	≥80	220Lm	3000K/4000K/6000K	White	120°
LLF013	9W	EPISTAR SMD	≥80	675Lm	3000K/4000K/6000K	White	120°
LLF014	12W	EPISTAR SMD	≥80	1020Lm	3000K/4000K/6000K	White	120°
LLF014A	18W	EPISTAR SMD	≥80	1530Lm	3000K/4000K/6000K	White	120°
LLF015	22W	EPISTAR SMD	≥80	1870Lm	3000K/4000K/6000K	White	120°
LLF016	30W	EPISTAR SMD	≥80	2550Lm	3000K/4000K/6000K	White	120°

PRODUCT DIMENSION

Unit (mm)

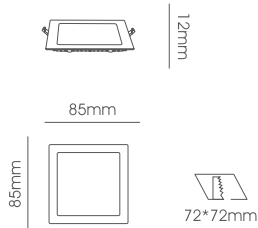

**LLF012-4W**  
Body Size: 85\*85\*12mm  
Cut-Size: 72\*72mm

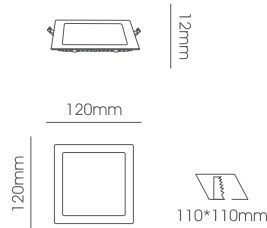

**LLF013-9W**  
Body Size: 120\*120\*12mm  
Cut-Size: 110\*110mm

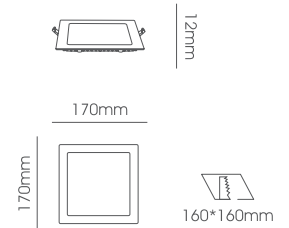

**LLF014-12W**  
Body Size: 170\*170\*12mm  
Cut-Size: 160\*160mm

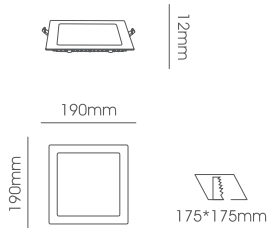

**LLF014A-18W**  
Body Size: 190\*190\*12mm  
Cut-Size: 175\*175mm

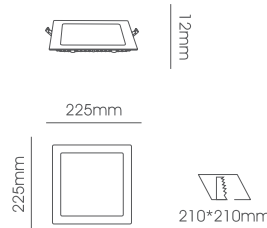

**LLF015-22W**  
Body Size: 225\*225\*12mm  
Cut-Size: 210\*210mm

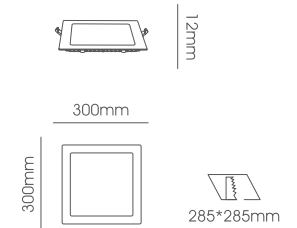

**LLF016-30W**  
Body Size: 300\*300\*12mm  
Cut-Size: 285\*285mm

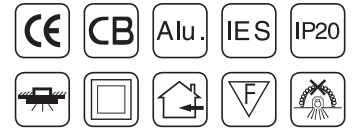

**PRODUCT PARAMETERS**

**EPISTAR**

Model No.	Power	LED Chip	CRI	Lumens	CCT	Body Color	Beam Angle
LLF018	6W	EPISTAR SMD	≥80	480Lm	3000K/4000K/6000K	White	120°
LLF019	12W	EPISTAR SMD	≥80	1020Lm	3000K/4000K/6000K	White	120°
LLF020	18W	EPISTAR SMD	≥80	1620Lm	3000K/4000K/6000K	White	120°
LLF021	24W	EPISTAR SMD	≥80	2160Lm	3000K/4000K/6000K	White	120°

**PRODUCT DIMENSION**

Unit (mm)



Ø90mm



**LLF018-6W**  
Body Size: Ø90\*30mm  
Cut-Size: Ø80mm



Ø120mm



**LLF019-12W**  
Body Size: Ø120\*30mm  
Cut-Size: Ø110mm



Ø170mm



**LLF020-18W**  
Body Size: Ø170\*30mm  
Cut-Size: Ø135mm



Ø225mm



**LLF021-24W**  
Body Size: Ø225\*30mm  
Cut-Size: Ø210mm

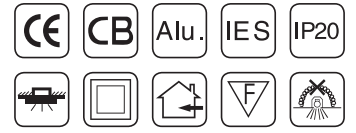

PRODUCT PARAMETERS

EPISTAR

Model No.	Power	LED Chip	CRI	Lumens	CCT	Body Color	Beam Angle
LLF026	6W	EPISTAR SMD	≥70	675Lm	3IN1	White	120°
LLF027	12W	EPISTAR SMD	≥70	1020Lm	3IN1	White	120°
LLF028	18W	EPISTAR SMD	≥70	1530Lm	3IN1	White	120°

PRODUCT DIMENSION

Unit (mm)



Ø120mm



Ø110mm

**LLF026-6W**  
Body Size: Ø120\*12mm  
Cut-Size: Ø110mm



Ø170mm



Ø160mm

**LLF027-12W**  
Body Size: Ø170\*12mm  
Cut-Size: Ø160mm



Ø225mm



Ø210mm

**LLF028-18W**  
Body Size: Ø225\*12mm  
Cut-Size: Ø210mm

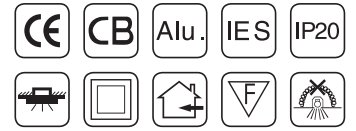

**PRODUCT PARAMETERS**

Model No.	Power	LED Chip	CRI	Lumens	CCT	Body Color	Beam Angle
LLF040	4W	SANAN SMD	≥80	90-100Lm/W	3000K/4000K/6000K	White	120°
LLF050	8W	EPISTAR SMD	≥80	110Lm/W	3000K/4000K/6000K	White	120°
LLF051	16W	EPISTAR SMD	≥80	110Lm/W	3000K/4000K/6000K	White	120°
LLF052	24W	EPISTAR SMD	≥80	110Lm/W	3000K/4000K/6000K	White	120°
LLF052A	30W	EPISTAR SMD	≥80	110Lm/W	3000K/4000K/6000K	White	120°

**PRODUCT DIMENSION**

Unit (mm)

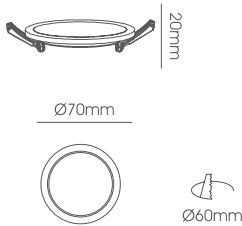

**LLF040-4W**  
Body Size: Ø70\*20mm  
Cut-Size: Ø60mm

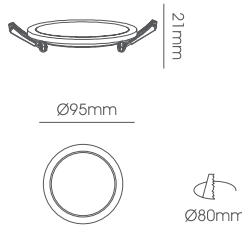

**LLF050-8W**  
Body Size: Ø95\*21mm  
Cut-Size: Ø80mm

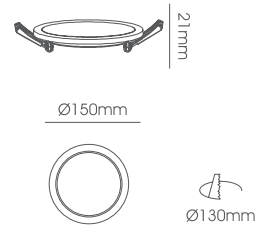

**LLF051-16W**  
Body Size: Ø150\*21mm  
Cut-Size: Ø130mm

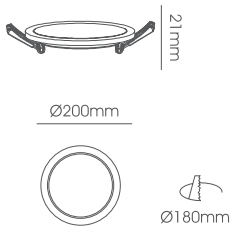

**LLF052-24W**  
Body Size: Ø200\*21mm  
Cut-Size: Ø180mm

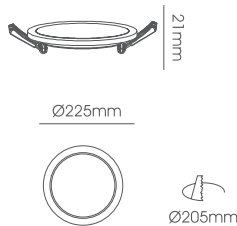

**LLF052A-30W**  
Body Size: Ø225\*21mm  
Cut-Size: Ø205mm

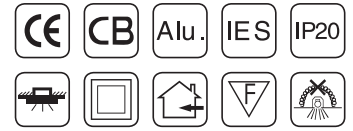

PRODUCT PARAMETERS



Model No.	Power	LED Chip	CRI	Lumens	CCT	Body Color	Beam Angle
LLF045	4W	SANAN SMD	≥80	90-100Lm/W	3000K/4000K/6000K	White	120°
LLF053	8W	EPISTAR SMD	≥80	110Lm/W	3000K/4000K/6000K	White	120°
LLF054	16W	EPISTAR SMD	≥80	110Lm/W	3000K/4000K/6000K	White	120°
LLF055	24W	EPISTAR SMD	≥80	110Lm/W	3000K/4000K/6000K	White	120°
LLF055A	30W	EPISTAR SMD	≥80	110Lm/W	3000K/4000K/6000K	White	120°

PRODUCT DIMENSION

Unit (mm)

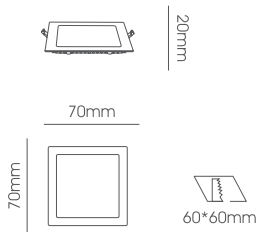

**LLF045-4W**  
Body Size: 70\*70\*20mm  
Cut-Size: 60\*60mm

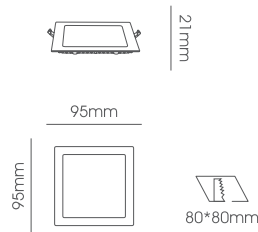

**LLF053-8W**  
Body Size: 95\*95\*21mm  
Cut-Size: 80\*80mm

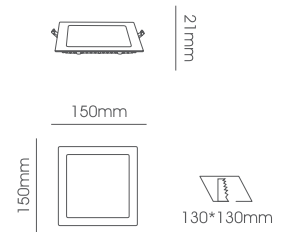

**LLF054-16W**  
Body Size: 150\*150\*21mm  
Cut-Size: 130\*130mm

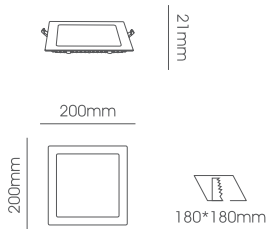

**LLF055-24W**  
Body Size: 200\*200\*21mm  
Cut-Size: 180\*180mm

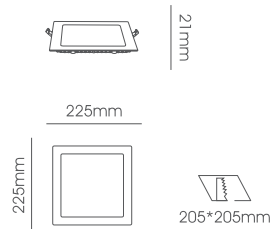

**LLF055A-30W**  
Body Size: 225\*225\*21mm  
Cut-Size: 205\*205mm





**LED LIGHTING DOWN LIGHT**



**CAN BE MADE TO ORDER**  
DIMMABLE/TUNABLE WITH RF CONTROL

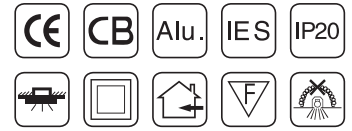

### PRODUCT PARAMETERS



Model No.	Power	LED Chip	CRI	Lumens	CCT	Body Color	Beam Angle
LLF216	5W	SANAN SMD	≥80	400Lm	3000K/4000K/6000K	White / Black	90°
LLF217	7W	SANAN SMD	≥80	560Lm	3000K/4000K/6000K	White / Black	90°
LLF218	12W	SANAN SMD	≥80	960Lm	3000K/4000K/6000K	White / Black	90°
LLF219	20W	SANAN SMD	≥80	1600Lm	3000K/4000K/6000K	White / Black	90°

### PRODUCT DIMENSION

Unit (mm)



Ø60mm



Ø55mm

**LLF216-5W**  
Body Size: Ø60\*40mm  
Cut-Size: Ø55mm



Ø80mm

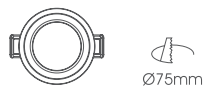

Ø75mm

**LLF217-7W**  
Body Size: Ø80\*45mm  
Cut-Size: Ø75mm



Ø90mm



Ø85mm

**LLF218-12W**  
Body Size: Ø90\*48mm  
Cut-Size: Ø85mm



Ø100mm



Ø95mm

**LLF219-20W**  
Body Size: Ø100\*53mm  
Cut-Size: Ø95mm

**MR-16 MODULES**



**PRODUCT PARAMETERS**



**LLD013**

Body Color: Black/White/Gold  
Body Size: Ø75\*58mm  
Cut-Size: Ø72mm



**LLD014**

Body Color: Black/White/Gold  
Body Size: Ø82\*50mm  
Cut-Size: Ø76mm



**LLD015**

Body Color: White  
Body Size: Ø82\*50mm  
Cut-Size: Ø76mm

**PRODUCT DIMENSION**

Unit (mm)



Ø75mm



Ø72mm



Ø82mm



Ø76mm



Ø82mm



Ø76mm

FRONT SERVICEABLE



LLD 016



LLD 017

PRODUCT PARAMETERS



Model No.	Power	LED Chip	CRI	Lumens	CCT	Body Color	Beam Angle
LLD 016	/	/	/	/	/	White / Black	/
LLD 017	/	/	/	/	/	White / Black	/

PRODUCT DIMENSION

Unit(mm)

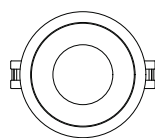
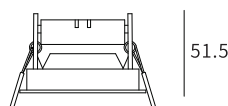

LLD 016  
Body Size : Ø82\*51.5  
Cut-Size : Ø75

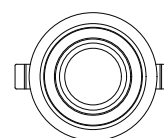
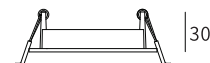

LLD 017  
Body Size : Ø96\*30  
Cut-Size : Ø85





# LED MODULES + FIXTURES SERIES

modular design  
Can be easily paired

APPLICATION SCENARIO

office

hotel

family



LED MODULES + FIXTURES  
SERIES

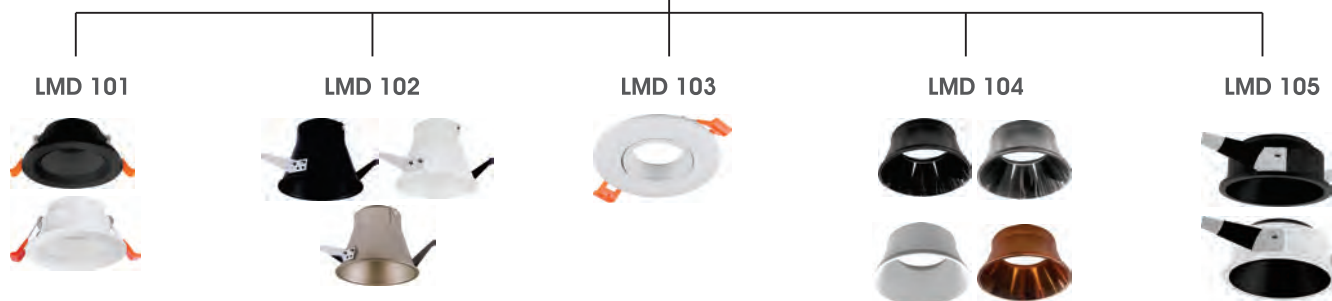

**LED MODULES –**  
SOFT LENS FILTER AVAILABLE TO  
CHANGE BEAM ANGLE

SUITABLE FOR LMD 101/102/103/104/105/106/107/108/109/110



**LMD 001**  
(IP20)



**LMD 002**  
(IP20)



**LMD 004**  
(IP65)



**LMD 005**  
(IP65)

SUITABLE FOR LMD 101/104/105



**LMD 003**  
(IP20)

**PRODUCT PARAMETERS**

**TOYONIA**

Model No.	Power	LED Chip	CRI	Lumens	CCT	Body Color	IP	Beam Angle
LMD 001	6W	TOYONIA	≥80	60-70lm/W	3000K/4000K	Black	IP20	12°/24°/36°
LMD 002	12W	TOYONIA	≥80	60-70lm/W	3000K/4000K	Black	IP20	12°/24°/36°
LMD 004	6W	TOYONIA	≥80	60-70lm/W	3000K	Black	IP65	12°/24°/36°
LMD 005	12W	TOYONIA	≥80	60-70lm/W	3000K	Black	IP65	12°/24°/36°
LMD 003	15W	TOYONIA	≥80	80-90lm/W	3000K	Black	IP20	12°/24°/36°

**LMD 001-6W**  
Body Size :Ø50\*37

**LMD 002-12W**  
Body Size :Ø50\*77

**LMD 004-6W**  
Body Size :Ø50\*67

**LMD 005-12W**  
Body Size :Ø50\*87

**LMD 003-15W**  
Body Size :Ø68\*62

DOWN LIGHT FIXTURE' S FOR MODULES  
SUITABLE FOR LMD 001/002/003/004/005

Lense avialble to change beam angle



**LMD 101**

Body color

- Black
- White



**LMD 102**

Body color

- Black
- White
- Gold



**LMD 103**

Body color

- White



**LMD 104**

Body color

- White
- Matt black



**LMD 105**

Body color

- Matt black



**LMD 106**

Body color

- Black
- All White



**LMD 107**

Body color

- Black
- White

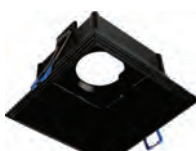

**LMD 108**

Body color

- Black
- White



**LMD 109**

Body color

- White



**LMD 110**

Body color

- Black
- White

PRODUCT PARAMETERS

Model No.	Power	Dimension (mm)	Cut-Out (mm)	Material	Body Color	IP
LMD 101	/	Ø95*36	Ø75	Aluminum	White / Black	IP44
LMD 102	/	Ø110*87	Ø105	Aluminum	White / Black / Gold	IP20
LMD 103	/	Ø103	Ø75	Aluminum	White	IP20
LMD 104	/	Ø82*36	Ø80	Aluminum	White / Mat Black	IP20
LMD 105	/	Ø82*36	Ø80	Aluminum	Matt Black	IP20
LMD 106	/	Ø94*45	Ø85	Aluminum	White / Black	IP20
LMD 107	/	Ø80*57	Ø75	Aluminum	White / Black	IP20
LMD 108	/	105*105*71(75)	95*95	Aluminum	White / Black	IP20
LMD 109	/	Ø85*25	Ø75	Aluminum	White	IP20
LMD 110	/	Ø75*36	Ø75	Aluminum	White / Black	IP20

# SURFACE/RECESSED SLIM MAGNETIC SERIES

---



Variety of styles, easy to combine  
Break through conventional design and create your own personalized space

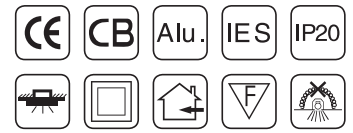

LMT 002



LMT 001



LMT 003

**PRODUCT PARAMETERS**

Model No.	Power	LED Chip	CRI	Lumens	CCT	Body Color	Beam Angle
LMT001	6W	COB	≥80	500Lm	3000K/4000K	White / Black / Brass	24°
LMT002	12W	COB	≥80	1100Lm	3000K/4000K	White / Black / Brass	24°
LMT003	18W	COB	≥80	1600Lm	3000K/4000K	White / Black / Brass	24°

**PRODUCT DIMENSION**

Unit(mm)

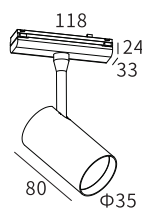

LMT001-6W  
Body Size :Ø35\*80

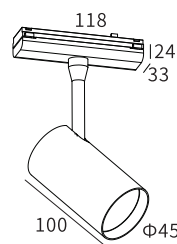

LMT002-12W  
Body Size :Ø45\*100

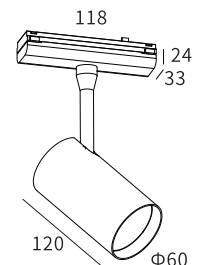

LMT003-18W  
Body Size :Ø60\*120



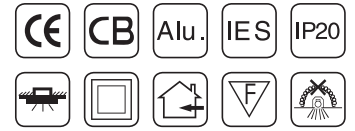

**PRODUCT PARAMETERS**

Model No.	Power	LED Chip	CRI	Lumens	CCT	Body Color	Beam Angle
LMT101	10W	LED	≥80	900Lm	3000K/4000K	White / Black	24°
LMT102	20W	LED	≥80	1800Lm	3000K/4000K	White / Black	24°
LMT103	30W	LED	≥80	2500Lm	3000K/4000K	White / Black	24°

**PRODUCT DIMENSION**

Unit(mm)

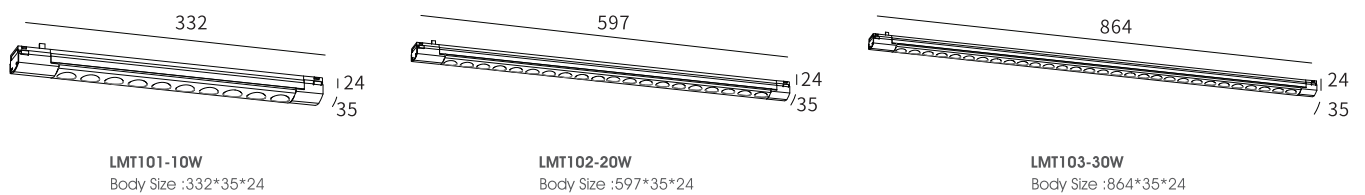

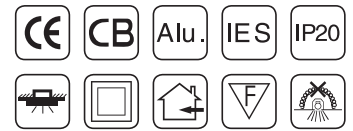

### PRODUCT PARAMETERS

Model No.	Power	LED Chip	CRI	Lumens	CCT	Body Color	Beam Angle
LMT104	6W	LED	≥80	500Lm	3000K/4000K	White / Black	24°
LMT105	12W	LED	≥80	1100Lm	3000K/4000K	White / Black	24°
LMT106	18W	LED	≥80	1600Lm	3000K/4000K	White / Black	24°
LMT107	24W	LED	≥80	2300Lm	3000K/4000K	White / Black	24°

### PRODUCT DIMENSION

Unit(mm)

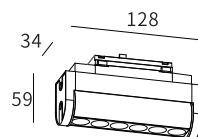

LMT104-6W  
Body Size :128\*34\*59

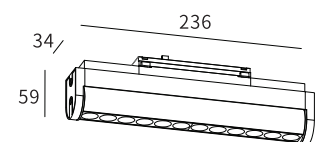

LMT105-12W  
Body Size :236\*34\*59

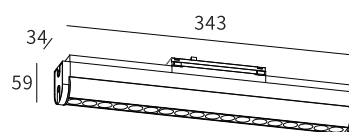

LMT106-18W  
Body Size :343\*34\*59

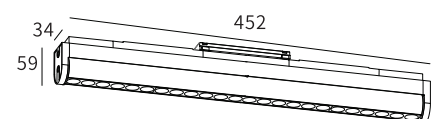

LMT107-18W  
Body Size :452\*34\*59

## SURFACE/RECESSED SLIM MAGNETIC SERIES

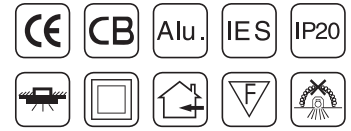

### PRODUCT PARAMETERS

Model No.	Power	LED Chip	CRI	Lumens	CCT	Body Color	Beam Angle
LMT201	10W	LED	≥80	900Lm	3000K/4000K	White / Black	100°
LMT202	20W	LED	≥80	1800Lm	3000K/4000K	White / Black	100°
LMT203	30W	LED	≥80	2500Lm	3000K/4000K	White / Black	100°

### PRODUCT DIMENSION

Unit(mm)

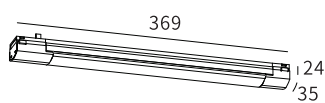

**LMT 201**  
Body Size :369\*35\*24

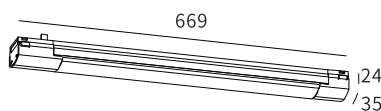

**LMT 202**  
Body Size :669\*35\*24

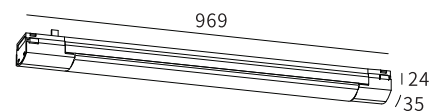

**LMT 203**  
Body Size :969\*35\*24

SURFACE/RECESSED SLIM MAGNETIC  
SERIES

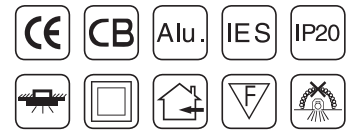

LMT301



LMT302

PRODUCT PARAMETERS

Model No.	Power	LED Chip	CRI	Lumens	CCT	Body Color	Beam Angle
LMT301	7W	COB	≥80	550Lm	3000K/4000K	White / Black	24°
LMT302	12W	COB	≥80	550Lm	3000K/4000K	White / Black	24°

PRODUCT DIMENSION

Unit(mm)

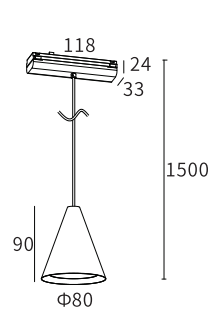

LMT 301  
Body Size :Ø80\*90

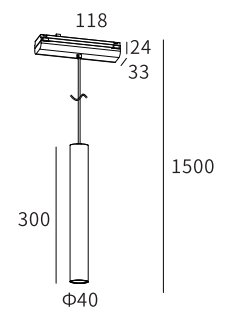

LMT 302  
Body Size :Ø40\*300

## SURFACE/RECESSED MAGNETIC SERIES



### PRODUCT PARAMETERS

Model No.	Power	Dimension (mm)	Cut-Out (mm)	Material	Body Color	IP
LMT401	/	35*10*1000	/	Aluminum	White / Black	IP20
LMT402	/	35*10*2000	/	Aluminum	White / Black	IP20
LMT403	/	35*10*3000	/	Aluminum	White / Black	IP20





SURFACE/RECESSED MAGNETIC  
SERIES

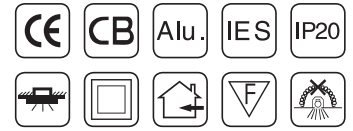

LMT404



LMT405



LMT406



LMT407



LMT408



LMT409



LMT410



LMT411

PRODUCT PARAMETERS

Model No.	Power	Dimension (mm)	Cut-Out (mm)	Material	Body Color	IP
LMT404	/	35*10*6.5	/	Plastic	White / Black	IP20
LMT405	/	77*35*20	/	Plastic	White / Black	IP20
LMT406	/	40*32*12	/	Plastic	White / Black	IP20
LMT407	/	62*62*18	/	Plastic	White / Black	IP20
LMT408	/	45*32*12	/	Plastic	White / Black	IP20
LMT409	100W	264*33*25	/	Plastic+Copper	White / Black	IP20
LMT410	200W	264*33*25	/	Plastic+Copper	White / Black	IP20
LMT411	/	62*34*31	/	Plastic	White / Black	IP20

PRODUCT DIMENSION

Unit(mm)

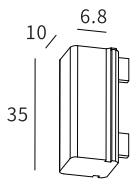

LMT-404

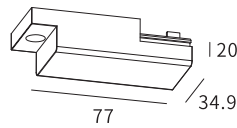

LMT-405

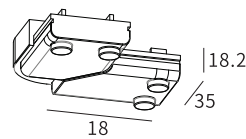

LMT-407

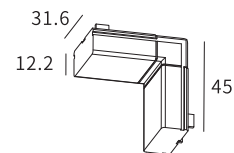

LMT-408



LMT-409



LMT-410

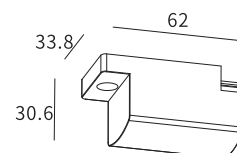

LMT-411

**LED Lum**  
Lighting.Simplified

# INDOOR LED LIGHTING

---

SURFACE DOWN LIGHT  
SERIES

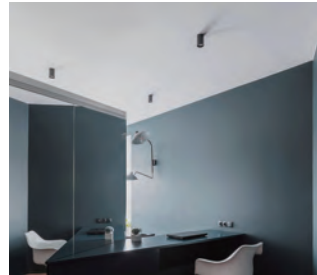
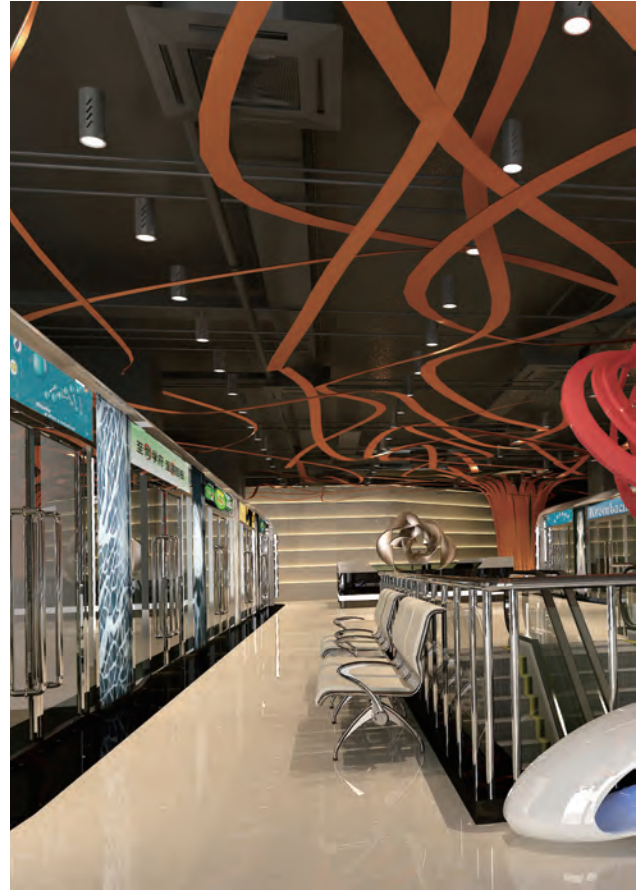

---

#### APPLICATION OF LED SURFACE DOWN LIGHT

Simple streamlined design, surface cover and the lamp can be used with different colors, different styles to meet the different demands.

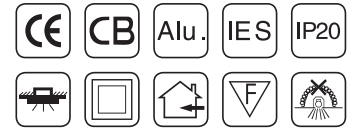

**PRODUCT PARAMETERS**

**EPISTAR**

Model No.	Power	LED Chip	CRI	Lumens	CCT	Body Color	Beam Angle
LLS001	6W	EPISTAR SMD	≥80	480Lm	3000K/4000K/6000K	White	120°
LLS002	12W	EPISTAR SMD	≥80	1020Lm	3000K/4000K/6000K	White	120°
LLS003	18W	EPISTAR SMD	≥80	1620Lm	3000K/4000K/6000K	White	120°
LLS004	24W	EPISTAR SMD	≥80	2160Lm	3000K/4000K/6000K	White	120°
LLS004A	30W	EPISTAR SMD	≥80	2700Lm	3000K/4000K/6000K	White	120°

**PRODUCT DIMENSION**

Unit (mm)

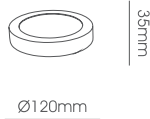

**LLS001-6W**  
Body Size:  
Ø120\*35mm



**LLS002-12W**  
Body Size:  
Ø170\*35mm



**LLS003-18W**  
Body Size:  
Ø225\*35mm

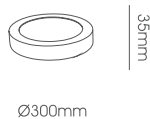

**LLS004-24W**  
Body Size:  
Ø300\*35mm



**LLS004A-30W**  
Body Size:  
Ø300\*35mm

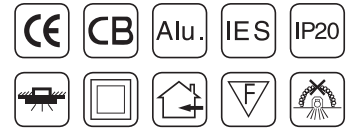

PRODUCT PARAMETERS

EPISTAR

Model No.	Power	LED Chip	CRI	Lumens	CCT	Body Color	Beam Angle
LLS005	6W	EPISTAR SMD	≥80	480Lm	3000K/4000K/6000K	White	120°
LLS006	12W	EPISTAR SMD	≥80	1020Lm	3000K/4000K/6000K	White	120°
LLS007	18W	EPISTAR SMD	≥80	1620Lm	3000K/4000K/6000K	White	120°
LLS008	24W	EPISTAR SMD	≥80	2160Lm	3000K/4000K/6000K	White	120°
LLS008A	30W	EPISTAR SMD	≥80	2700Lm	3000K/4000K/6000K	White	120°

PRODUCT DIMENSION

Unit (mm)

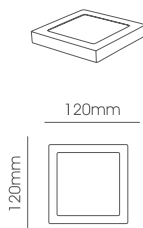

**LLS005-6W**  
Body Size:  
120\*120\*35mm

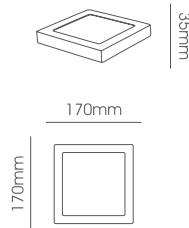

**LLS006-12W**  
Body Size:  
170\*170\*35mm

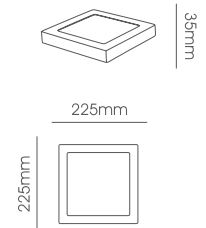

**LLS007-18W**  
Body Size:  
225\*225\*35mm

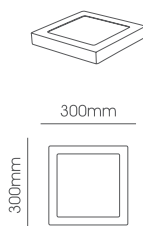

**LLS008-24W**  
Body Size:  
300\*300\*35mm

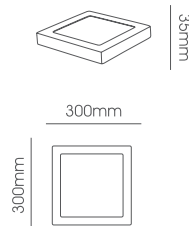

**LLS008A-30W**  
Body Size:  
300\*300\*35mm



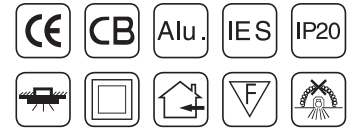

## PRODUCT PARAMETERS



Model No.	Power	LED Chip	CRI	Lumens	CCT	Body Color	Beam Angle
LLS011	7W	SANAN SMD	≥80	90-100lm/W	3000K/4000K/6000K	White	160°
LLS011A	14W	SANAN SMD	≥80	90-100lm/W	3000K/4000K/6000K	White	160°
LLS011B	21W	SANAN SMD	≥80	90-100lm/W	3000K/4000K/6000K	White	160°

## PRODUCT DIMENSION

Unit (mm)



Ø100mm



**LLS011-7W**  
Body Size:  
Ø100\*16mm



Ø150mm



**LLS011A-14W**  
Body Size:  
Ø150\*16mm



Ø175mm



**LLS011B-21W**  
Body Size:  
Ø175\*16mm

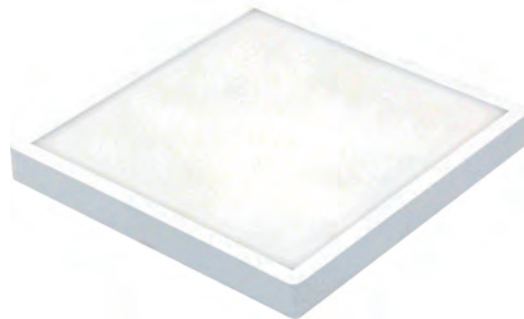
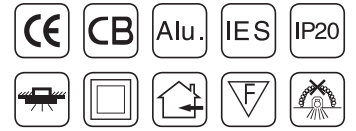

## PRODUCT PARAMETERS



Model No.	Power	LED Chip	CRI	Lumens	CCT	Body Color	Beam Angle
LLS012	7W	SANAN SMD	≥80	90-100lm/W	3000K/4000K/6000K	White	160°
LLS012A	14W	SANAN SMD	≥80	90-100lm/W	3000K/4000K/6000K	White	160°
LLS012B	21W	SANAN SMD	≥80	90-100lm/W	3000K/4000K/6000K	White	160°

## PRODUCT DIMENSION

Unit (mm)

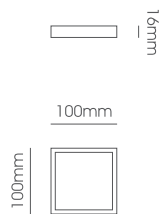

**LLS012-7W**  
Body Size:  
100\*100\*16mm

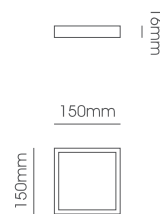

**LLS012A-14W**  
Body Size:  
150\*150\*16mm

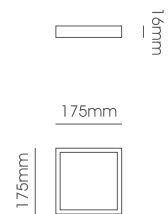

**LLS012B-21W**  
Body Size:  
175\*175\*16mm

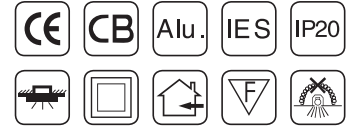

**PRODUCT PARAMETERS**

**EPISTAR**

Model No.	Power	LED Chip	CRI	Lumens	CCT	Body Color	Beam Angle
LLS021A	8W	EPISTAR SMD	≥80	110Lm/W	3000K/4000K/6000K	White	120°
LLS022A	16W	EPISTAR SMD	≥80	110Lm/W	3000K/4000K/6000K	White	120°
LLS023A	24W	EPISTAR SMD	≥80	110Lm/W	3000K/4000K/6000K	White	120°
LLS023B	30W	EPISTAR SMD	≥80	110Lm/W	3000K/4000K/6000K	White	120°

**PRODUCT DIMENSION**

Unit (mm)



Ø95mm



**LLS021A-8W**  
Body Size:  
Ø95\*25mm



Ø150mm



**LLS022A-16W**  
Body Size:  
Ø150\*25mm



Ø200mm



**LLS023A-24W**  
Body Size:  
Ø200\*25mm



Ø225mm



**LLS023B-30W**  
Body Size:  
Ø225\*25mm

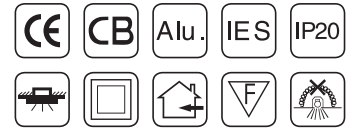

PRODUCT PARAMETERS

EPISTAR

Model No.	Power	LED Chip	CRI	Lumens	CCT	Body Color	Beam Angle
LLS024A	8W	EPISTAR SMD	≥80	110Lm/W	3000K/4000K/6000K	White	120°
LLS025A	16W	EPISTAR SMD	≥80	110Lm/W	3000K/4000K/6000K	White	120°
LLS026A	24W	EPISTAR SMD	≥80	110Lm/W	3000K/4000K/6000K	White	120°
LLS026B	30W	EPISTAR SMD	≥80	110Lm/W	3000K/4000K/6000K	White	120°

PRODUCT DIMENSION

Unit (mm)

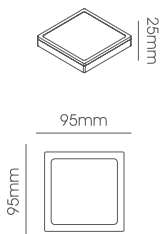

LLS024A-8W  
Body Size:  
95\*95\*25mm

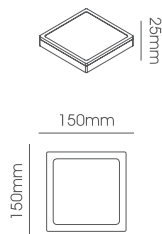

LLS025A-16W  
Body Size:  
150\*150\*25mm

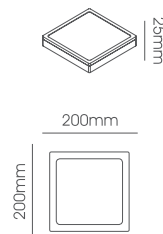

LLS026A-24W  
Body Size:  
200\*200\*25mm

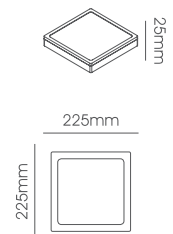

LLS026B-30W  
Body Size:  
225\*225\*25mm

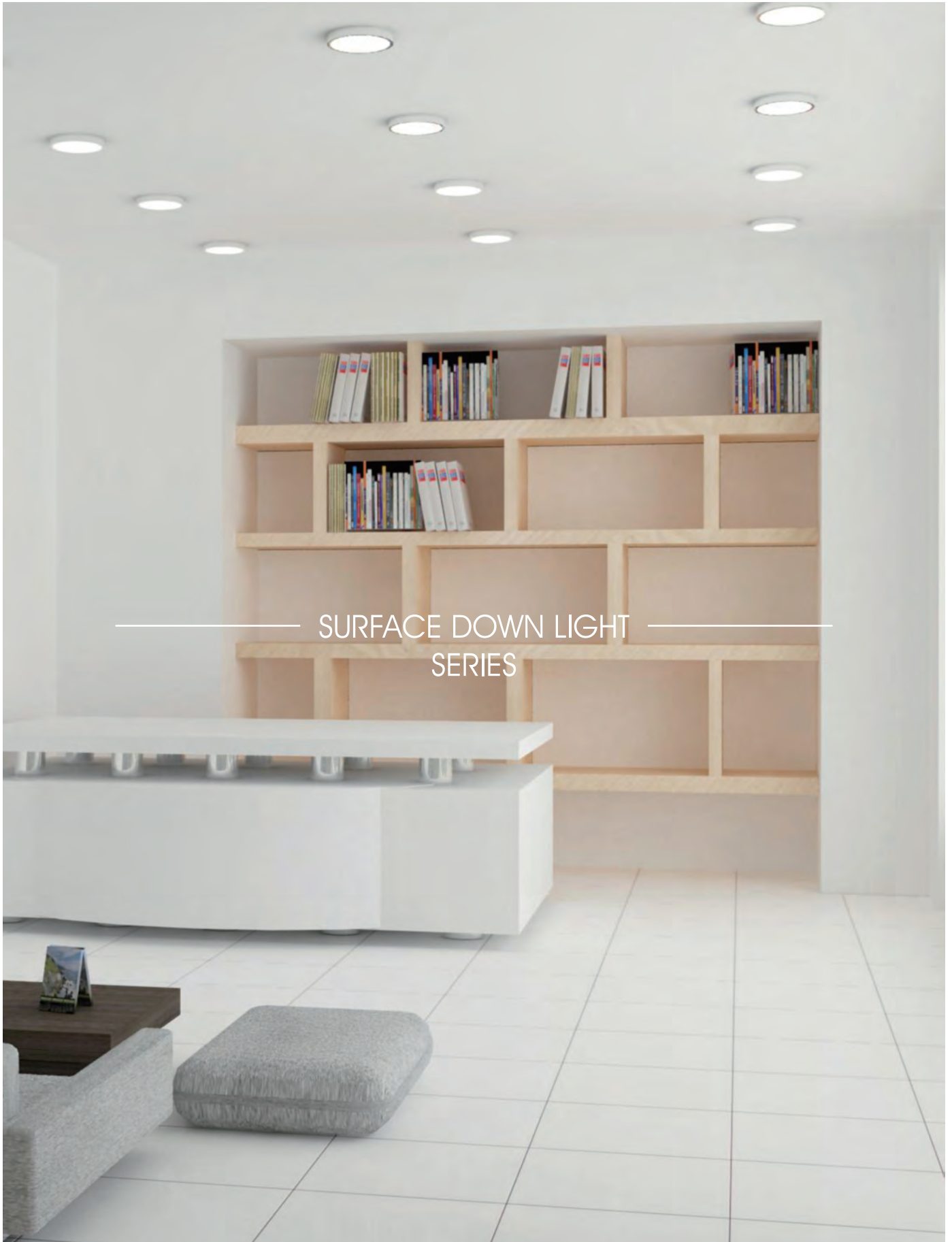

SURFACE DOWN LIGHT  
SERIES



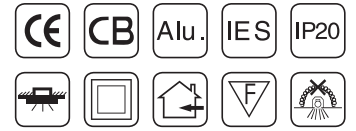

LLS027-LLS028



LLS029-LLS030

PRODUCT PARAMETERS



Model No.	Power	LED Chip	CRI	Lumens	CCT	Body Color	Beam Angle
LLS027	3W	BRIDGELUX SMD	≥80	80lm/W	3000K/4000K/6000K	White	180°
LLS028	6W	BRIDGELUX SMD	≥80	80lm/W	3000K/4000K/6000K	White	180°
LLS029	3W	BRIDGELUX SMD	≥80	80lm/W	3000K/4000K/6000K	White	180°
LLS030	6W	BRIDGELUX SMD	≥80	80lm/W	3000K/4000K/6000K	White	180°

PRODUCT DIMENSION

Unit (mm)



Ø60mm



LLS027-3W  
Body Size:  
Ø60\*10mm



Ø80mm



LLS028-6W  
Body Size:  
Ø80\*10mm



60mm



LLS029-3W  
Body Size:  
60\*60\*10mm



80mm



LLS030-6W  
Body Size:  
80\*80\*10mm

# LED LIGHTING

SURFACE DOWN LIGHT SERIES RIMLESS

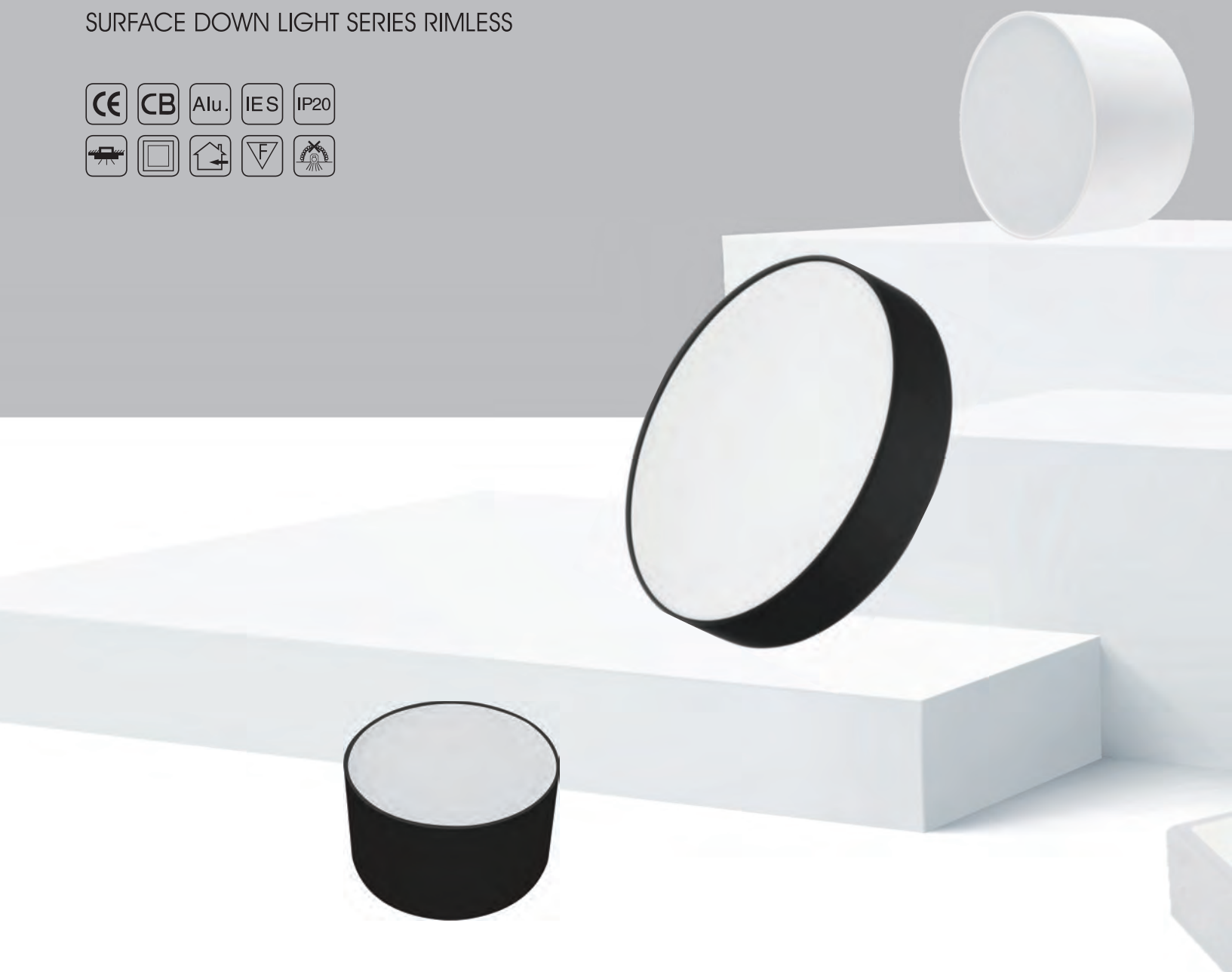

LED CHIP  
**EVERLIGHT**



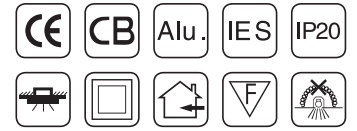

**PRODUCT PARAMETERS**

**EVERLIGHT**

Model No.	Power	LED Chip	CRI	Lumens	CCT	Body Color	Beam Angle
LLS018	8W	EVERLIGHT SMD	≥80	560-640Lm	3000K/4000K/6000K	White / Black	100°
LLS019	12W	EVERLIGHT SMD	≥80	840-960Lm	3000K/4000K/6000K	White / Black	100°
LLS020	16W	EVERLIGHT SMD	≥80	1120-1280Lm	3000K/4000K/6000K	White / Black	100°

**PRODUCT DIMENSION**

Unit (mm)

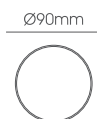

**LLS018-8W**  
Body Size:  
Ø90\*60mm



**LLS019-12W**  
Body Size:  
Ø120\*65mm

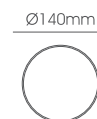

**LLS020-16W**  
Body Size:  
Ø140\*65mm

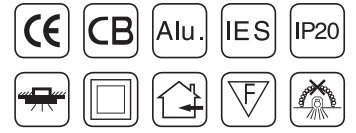

PRODUCT PARAMETERS

EVERLIGHT

Model No.	Power	LED Chip	CRI	Lumens	CCT	Body Color	Beam Angle
LLS058	16W	EVERLIGHT SMD	≥80	1280-1440Lm	3000K/4000K/6000K	White / Black	120°
LLS059	20W	EVERLIGHT SMD	≥80	1600-1800Lm	3000K/4000K/6000K	White / Black	120°
LLS060	30W	EVERLIGHT SMD	≥80	2400-2700Lm	3000K/4000K/6000K	White / Black	120°

PRODUCT DIMENSION

Unit (mm)



Ø175mm

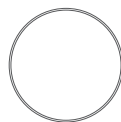

LLS058-16W  
Body Size:  
Ø175\*41mm



Ø210mm

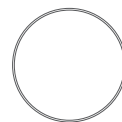

LLS059-20W  
Body Size:  
Ø210\*41mm



Ø250mm

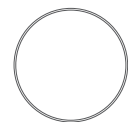

LLS060-30W  
Body Size:  
Ø250\*45mm



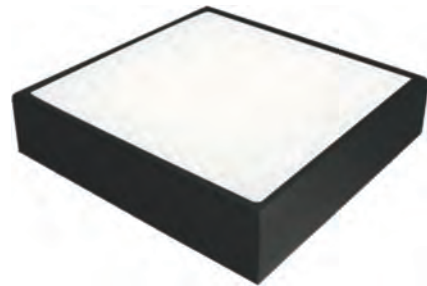
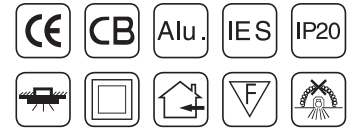

**PRODUCT PARAMETERS**

**EVERLIGHT**

Model No.	Power	LED Chip	CRI	Lumens	CCT	Body Color	Beam Angle
LLS061	16W	EVERLIGHT SMD	≥80	1600-1800lm	3000K/4000K/6000K	White / Black	120°
LLS062	20W	EVERLIGHT SMD	≥80	2400-2700lm	3000K/4000K/6000K	White / Black	120°

**PRODUCT DIMENSION**

Unit (mm)

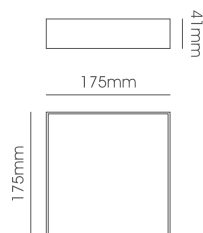

**LLS061-16W**  
Body Size:  
175\*175\*41mm

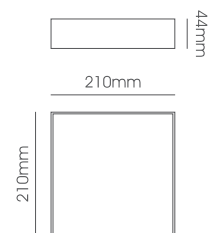

**LLS062-20W**  
Body Size:  
210\*210\*44mm

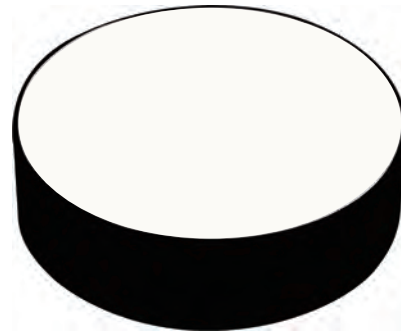
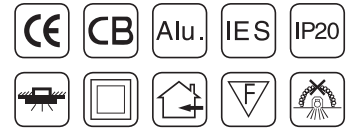

PRODUCT PARAMETERS

EPISTAR

Model No.	Power	LED Chip	CRI	Lumens	CCT	Body Color	Beam Angle
LLS092	12W	EPISTAR SMD	≥80	80Lm/W	3000K/4000K/6000K	White / Black	120°
LLS093	18W	EPISTAR SMD	≥80	80Lm/W	3000K/4000K/6000K	White / Black	120°
LLS094	24W	EPISTAR SMD	≥80	80Lm/W	3000K/4000K/6000K	White / Black	120°

PRODUCT DIMENSION

Unit (mm)

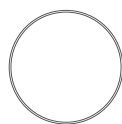
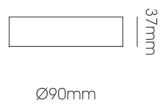

LLS092-12W  
Body Size:  
Ø90\*37mm

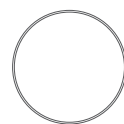
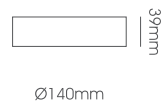

LLS093-18W  
Body Size:  
Ø140\*39mm

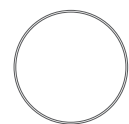

LLS094-24W  
Body Size:  
Ø205\*42mm

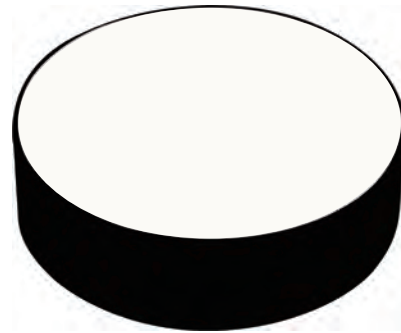
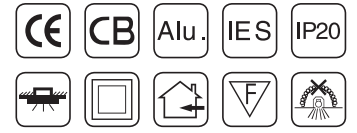

**PRODUCT PARAMETERS**



Model No.	Power	LED Chip	CRI	Lumens	CCT	Body Color	Beam Angle
LLS092A	10W	BRIDGELUX SMD 2835	≥80	80lm/W	3000K/4000K/6000K	White / Black	160°
LLS093A	16W	BRIDGELUX SMD 2835	≥80	80lm/W	3000K/4000K/6000K	White / Black	160°
LLS094A	22W	BRIDGELUX SMD 2835	≥80	80lm/W	3000K/4000K/6000K	White / Black	160°

**PRODUCT DIMENSION**

Unit (mm)



Ø96mm

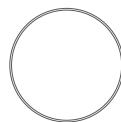

**LLS092A-10W**  
Body Size :  
Ø96\*32mm



Ø155mm

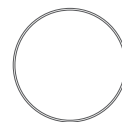

**LLS093A-16W**  
Body Size :  
Ø155\*35mm



Ø180mm

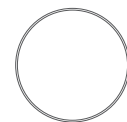

**LLS094A-22W**  
Body Size :  
Ø180\*35mm

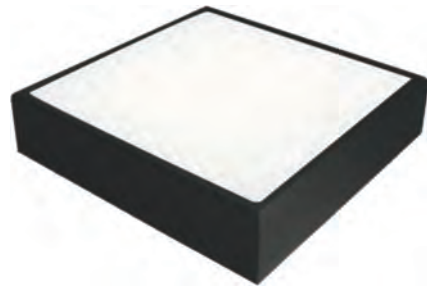
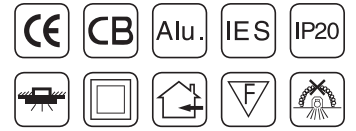

### PRODUCT PARAMETERS



Model No.	Power	LED Chip	CRI	Lumens	CCT	Body Color	Beam Angle
LLS092B	10W	BRIDGELUX SMD 2835	≥80	80Lm/W	3000K/4000K/6000K	White / Black	160°
LLS093B	16W	BRIDGELUX SMD 2835	≥80	80Lm/W	3000K/4000K/6000K	White / Black	160°
LLS094B	22W	BRIDGELUX SMD 2835	≥80	80Lm/W	3000K/4000K/6000K	White / Black	160°

### PRODUCT DIMENSION

Unit (mm)

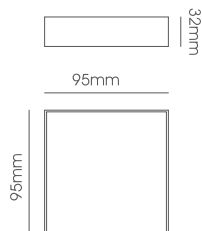

**LLS092B-10W**  
Body Size :  
95\*95\*32mm

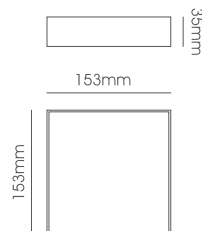

**LLS093B-16W**  
Body Size :  
153\*153\*35mm

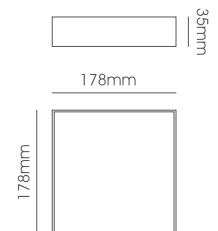

**LLS094B-22W**  
Body Size :  
178\*178\*35mm

# MINI SMD/COB SURFACE FIXTURES SERIES

---

Large diameter luminous mask  
Increase exposure range and enhance spatial brightness



#### APPLICATION SCENARIO

office

hotel

family



## MINI SMD/COB SURFACE FIXTURES

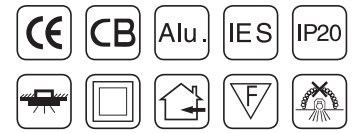

LLS 111

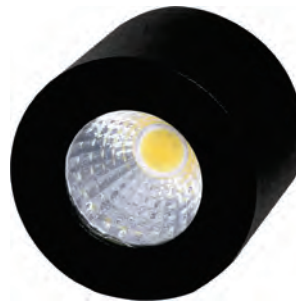

LLS 113



LLS 112

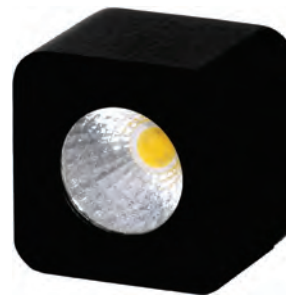

LLS 114

### PRODUCT PARAMETERS



Model No.	Power	LED Chip	CRI	Lumens	CCT	Body Color	Beam Angle
LLS 111	3W	SMD	≥80	270-300lm	3000K/4000K	Sand White / Sand Black	180°
LLS 112	3W	SMD	≥80	270-300lm	3000K/4000K	Sand White / Sand Black	180°
LLS 113	3W	COB	≥80	270-300lm	3000K/4000K	Sand White / Sand Black	60°
LLS 114	3W	COB	≥80	270-300lm	3000K/4000K	Sand White / Sand Black	60°

### PRODUCT DIMENSION

Unit(mm)

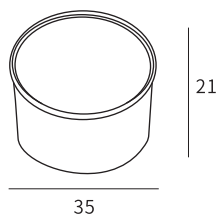

LLS 111-3W  
Body Size :35\*21

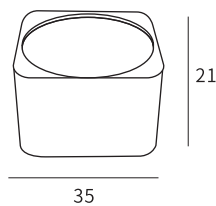

LLS 112-3W  
Body Size :35\*21

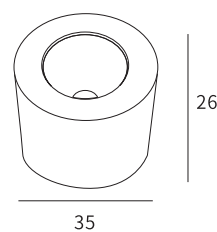

LLS 113-3W  
Body Size :35\*26

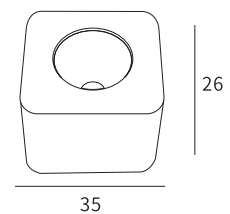

LLS 114-3W  
Body Size :35\*26



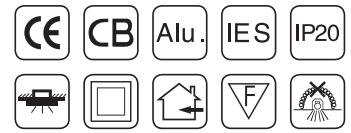

LLS 120A (SMD)



LLS 121A (SMD)



LLS 122A (SMD)



LLS 123A (SMD)



PRODUCT PARAMETERS



Model No.	Power	LED Chip	CRI	Lumens	CCT	Body Color	Beam Angle
LLS 120A (SMD)	7W	SMD-Bridgelux	≥90	595Lm	3000K/4000K/5000K/6000k	White / Black	38°
LLS 121A (SMD)	12W	SMD-Bridgelux	≥90	1020Lm	3000K/4000K/5000K/6000k	White / Black	38°
LLS 122A (SMD)	18W	SMD-Bridgelux	≥90	1530Lm	3000K/4000K/5000K/6000k	White / Black	38°
LLS 123A (SMD)	24W	SMD-Bridgelux	≥90	2040Lm	3000K/4000K/5000K/6000k	White / Black	38°

PRODUCT DIMENSION

Unit(mm)

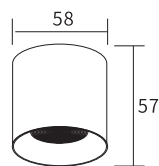

LLS 120A(SMD)-7W  
Body Size :Ø58\*57

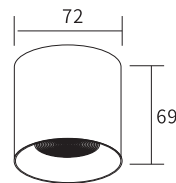

LLS 121A(SMD)-12W  
Body Size :Ø72\*69

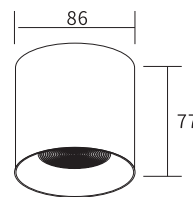

LLS 122A(SMD)-18W  
Body Size :Ø86\*77

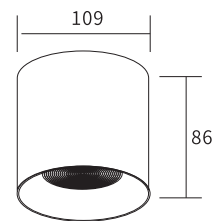

LLS 123A(SMD)-24W  
Body Size :Ø109\*86

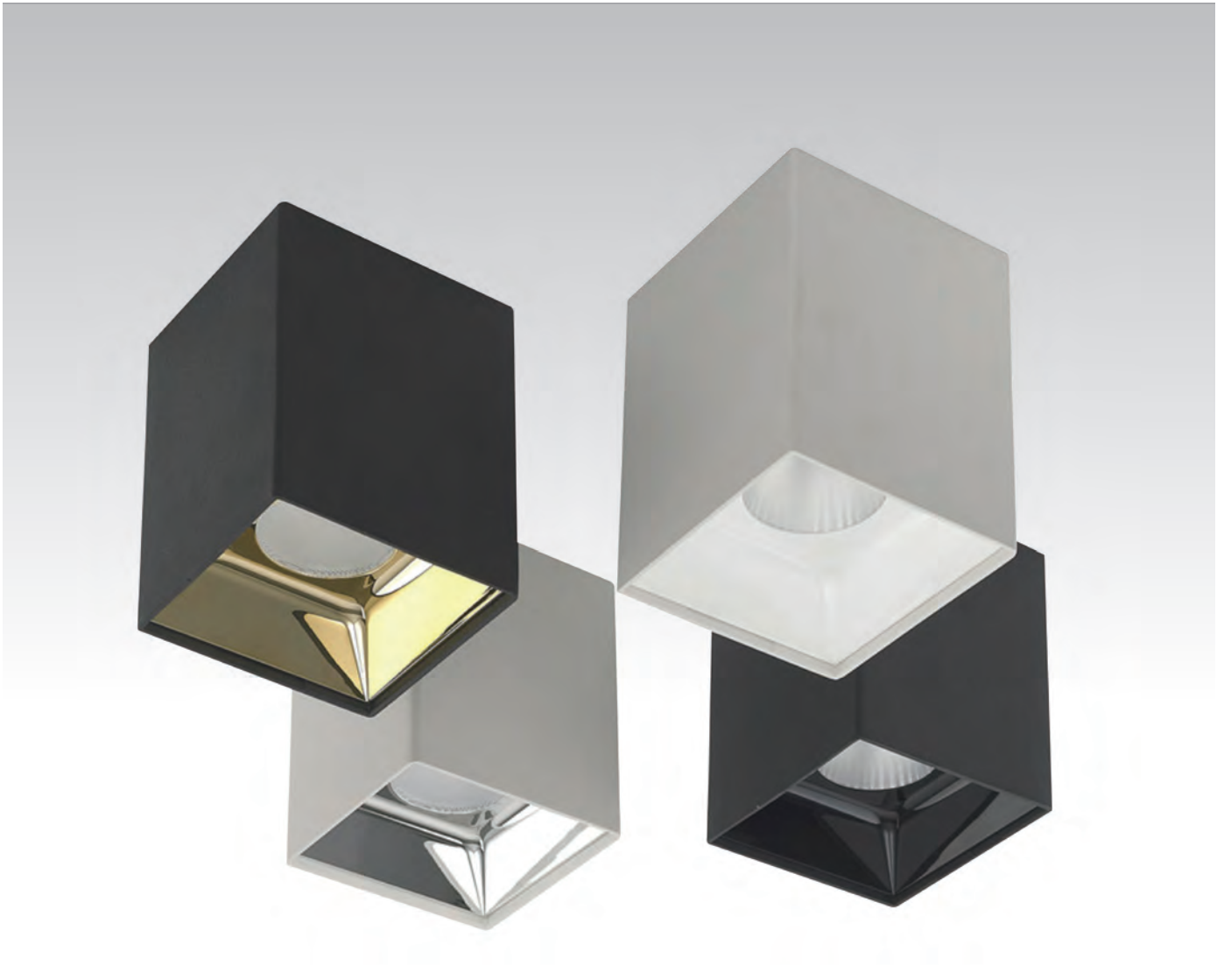

**REFLECTOR AVAILABLE**

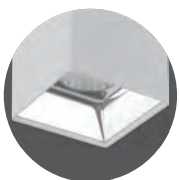

SILVER

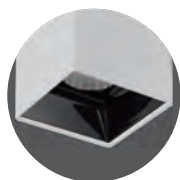

BLACK

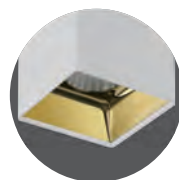

GOLD

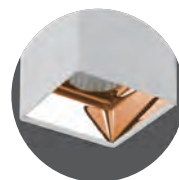

ROSE GOLD

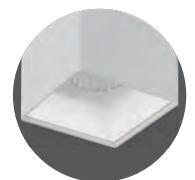

WHITE

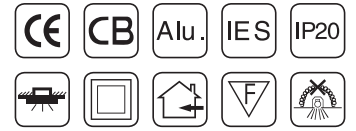

PRODUCT PARAMETERS



Model No.	Power	LED Chip	CRI	Lumens	CCT	Body Color	Beam Angle
LLS046	12W	BRIDGELUX COB	≥90	960-1080Lm	3000K/4000K/6000K	Black+Gold / White+Silver	30°
LLS046A	20W	BRIDGELUX COB	≥90	1600-1800Lm	3000K/4000K/6000K	Black+Gold / White+Silver	30°
LLS046B	30W	BRIDGELUX COB	≥90	2400-2700Lm	3000K/4000K/6000K	Black+Gold / White+Silver	30°
LLS047	12W	BRIDGELUX COB	≥90	960-1080Lm	3000K/4000K/6000K	Black+Gold / White+Silver	30°

PRODUCT DIMENSION

Unit (mm)

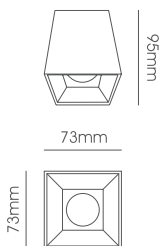

LLS046-12W  
Body Size:  
73\*73\*95mm

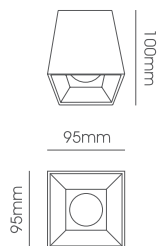

LLS046A-20W  
Body Size:  
95\*95\*100mm

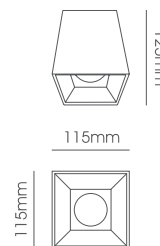

LLS046B-30W  
Body Size:  
115\*115\*125mm

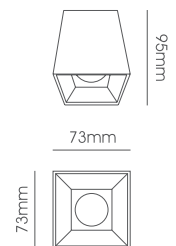

LLS047-12W  
Body Size:  
73\*73\*95mm





REFLECTOR AVAILABLE

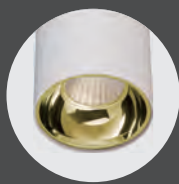
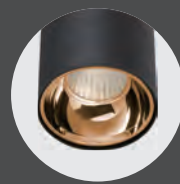
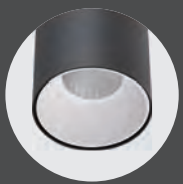

WHITE

BLACK

GOLD

ROSE GOLD

SILVER

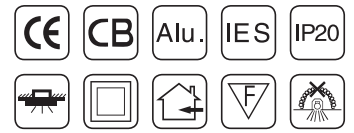

### PRODUCT PARAMETERS



Model No.	Power	LED Chip	CRI	Lumens	CCT	Body Color	Beam Angle
LLS068	12W	BRIDGELUX COB	≥90	900-980Lm	3000K/4000K/6000K	White+White / Black+Black	30°
LLS069	20W	BRIDGELUX COB	≥90	1600-1800Lm	3000K/4000K/6000K	White+White / Black+Black	30°
LLS070	30W	BRIDGELUX COB	≥90	2400-2700Lm	3000K/4000K/6000K	White+White / Black+Black	30°

### PRODUCT DIMENSION

Unit (mm)



Ø73mm



**LLS068-12W**  
Body Size:  
Ø73\*100mm



Ø94mm



**LLS069-20W**  
Body Size:  
Ø94\*116mm

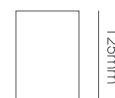

Ø115mm



**LLS070-30W**  
Body Size:  
Ø115\*125mm

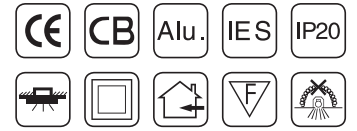

**PRODUCT PARAMETERS**

**EPISTAR**

Model No.	Power	LED Chip	CRI	Lumens	CCT	Body Color	Beam Angle
LLS036	10W	EPISTAR COB	≥80	80Lm/W	3000K/4000K/6000K	White	64°
LLS037	20W	EPISTAR COB	≥80	80Lm/W	3000K/4000K/6000K	White	40°
LLS038	30W	EPISTAR COB	≥80	80Lm/W	3000K/4000K/6000K	White	30°

**PRODUCT DIMENSION**

Unit (mm)

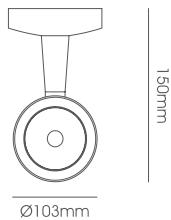

**LLS036-10W**  
Body Size:  
Ø103\*150mm

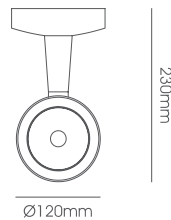

**LLS037-20W**  
Body Size:  
Ø120\*230mm

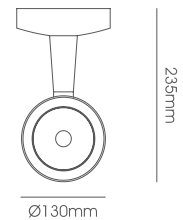

**LLS038-30W**  
Body Size:  
Ø130\*235mm

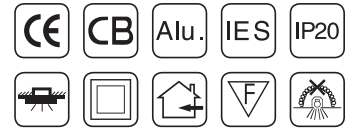

PRODUCT PARAMETERS



Model No.	Power	LED Chip	CRI	Lumens	CCT	Body Color	Beam Angle
LLS048	7W	BRIDGELUX COB	≥90	560-630Lm	3000K/4000K/6000K	White / Black	60°
LLS049	12W	BRIDGELUX COB	≥90	960-1080Lm	3000K/4000K/6000K	White / Black	60°
LLS050	20W	BRIDGELUX COB	≥90	1600-1800Lm	3000K/4000K/6000K	White / Black	60°
LLS051	30W	BRIDGELUX COB	≥90	2400-2700Lm	3000K/4000K/6000K	White / Black	60°
LLS052	40W	BRIDGELUX COB	≥90	3200-3500Lm	3000K/4000K/6000K	White / Black	60°

PRODUCT DIMENSION

Unit (mm)



Ø60mm



**LLS048-7W**  
Body Size:  
Ø60\*95mm

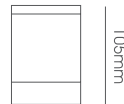

Ø70mm



**LLS049-12W**  
Body Size:  
Ø70\*105mm



Ø100mm



**LLS050-20W**  
Body Size:  
Ø100\*130mm



Ø120mm



**LLS051-30W**  
Body Size:  
Ø120\*165mm

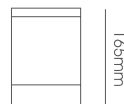

Ø140mm



**LLS052-40W**  
Body Size:  
Ø140\*165mm

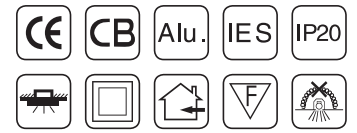

**PRODUCT PARAMETERS**



Model No.	Power	LED Chip	CRI	Lumens	CCT	Body Color	Beam Angle
LLS072	10W	BRIDGELUX COB	≥80	80lm/W	3000K/4000K/6000K	White / Black	38°
LLS073	20W	BRIDGELUX COB	≥80	80lm/W	3000K/4000K/6000K	White / Black	38°
LLS074	30W	BRIDGELUX COB	≥80	80lm/W	3000K/4000K/6000K	White / Black	38°
LLS075	40W	BRIDGELUX COB	≥80	80lm/W	3000K/4000K/6000K	White / Black	38°

**PRODUCT DIMENSION**

Unit (mm)

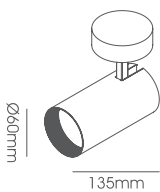

**LLS072-10W**  
Body Size:  
Ø60\*135\*132mm

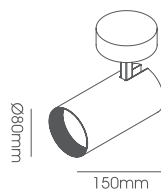

**LLS073-20W**  
Body Size:  
Ø80\*150\*157mm

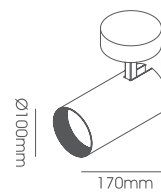

**LLS074-30W**  
Body Size:  
Ø100\*170\*160mm

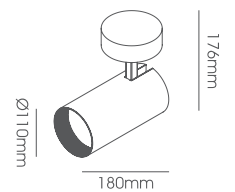

**LLS075-40W**  
Body Size:  
Ø110\*180\*176mm



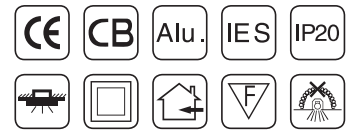

**PRODUCT PARAMETERS**



Model No.	Power	LED Chip	CRI	Lumens	CCT	Body Color	Beam Angle
LLS076	15W	CREE COB	≥90	80lm/W	3000K/4000K	White / Black	38°
LLS077	10W	BRIDGELUX COB	≥80	80lm/W	3000K/4000K	White / Black	38°
LLS078	18W	BRIDGELUX COB	≥80	80lm/W	3000K/4000K	White / Black	38°

**PRODUCT DIMENSION**

Unit (mm)

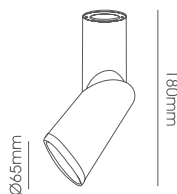

**LLS076-15W**  
Body Size:  
Ø65\*180mm

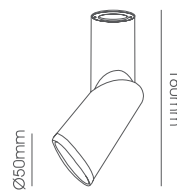

**LLS077-10W**  
Body Size:  
Ø50\*160mm

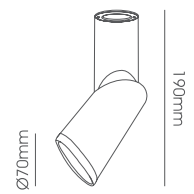

**LLS078-18W**  
Body Size:  
Ø70\*190mm

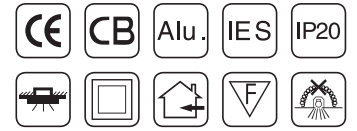

**LLS084**



**LLS085**

**PRODUCT PARAMETERS**



Model No.	Power	LED Chip	CRI	Lumens	CCT	Body Color	Beam Angle
LLS084	8W	SANAN COB	≥80	465Lm	3000K/4000K	White / Black	38°
LLS085	8W	SANAN COB	≥80	465Lm	3000K/4000K	White / Black	38°

**PRODUCT DIMENSION**

Unit (mm)

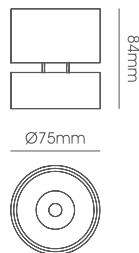

**LLS084-8W**  
Body Size:  
Ø75\*84mm

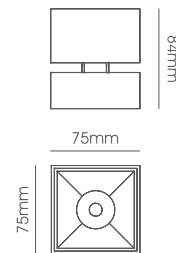

**LLS085-8W**  
Body Size:  
75\*75\*84mm

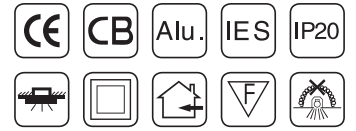

LLF205-TRACK

LLS087-SURFACE



LLS086-SURFACE

PRODUCT PARAMETERS

Model No.	Power	LED Chip	CRI	Lumens	CCT	Body Color	Beam Angle
LLF205-TRACK	/	GU10	/	/	/	White / Black	/
LLS086-SURFACE	/	GU10	/	/	/	White / Black	/
LLS087-SURFACE	/	GU10	/	/	/	White / Black	/

PRODUCT DIMENSION

Unit (mm)

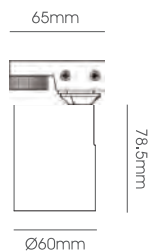

LLF205-TRACK  
Body Size: Ø60\*78.5mm  
Base Size: 65mm

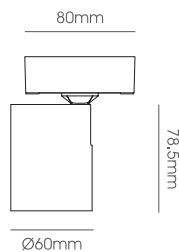

LLS086-SURFACE  
Body Size: Ø60\*78.5mm  
Base Size: 80mm

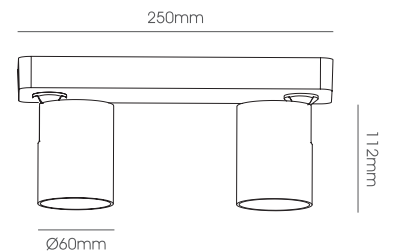

LLS087-SURFACE  
Body Size: Ø60\*112mm  
Base Size: 250mm

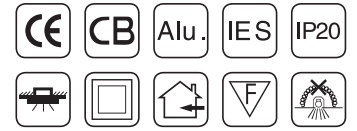

**LLS079**



**LLS080**



**LLS081**

**PRODUCT PARAMETERS**



Model No.	Power	LED Chip	CRI	Lumens	CCT	Body Color	Beam Angle
LLS079	10W	BRIDGELUX COB	≥80	80Lm/W	3000K/4000K	White / Black	24°
LLS080	10W*2	BRIDGELUX COB	≥80	80Lm/W	3000K/4000K	White / Black	24°
LLS081	8W	BRIDGELUX COB	≥80	80Lm/W	3000K/4000K	White / Black	24°

**PRODUCT DIMENSION**

Unit (mm)

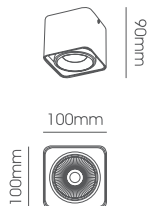

**LLS079-10W**  
Body Size:  
100\*100\*90mm

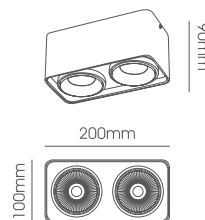

**LLS080-10W\*2**  
Body Size:  
200\*100\*90mm

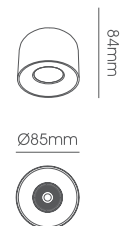

**LLS081-8W**  
Body Size:  
Ø85\*84mm

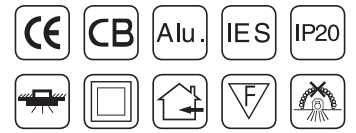

PRODUCT PARAMETERS



Model No.	Power	LED Chip	CRI	Lumens	CCT	Body Color	Beam Angle
LLS095	7W	CREE COB	≥80	560Lm	3000K/4000K	White / Black	36°
LLS096	12W	CREE COB	≥80	960Lm	3000K/4000K	White / Black	36°
LLS097	2*7W	CREE COB	≥80	1120Lm	3000K/4000K	White / Black	36°
LLS098	2*12W	CREE COB	≥80	1920Lm	3000K/4000K	White / Black	36°

PRODUCT DIMENSION

Unit (mm)

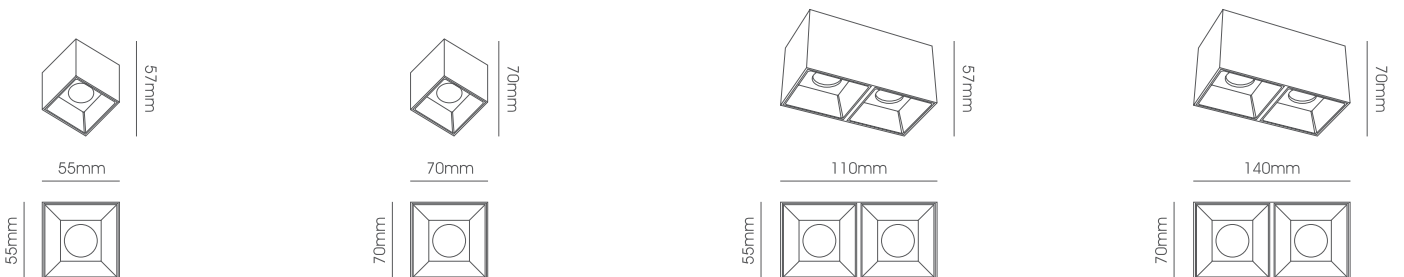

**LLS095-7W**  
Body Size:  
55\*55\*57mm

**LLS096-12W**  
Body Size:  
70\*70\*70mm

**LLS097-2\*7W**  
Body Size:  
110\*55\*57mm

**LLS098-2\*12W**  
Body Size:  
140\*70\*70mm

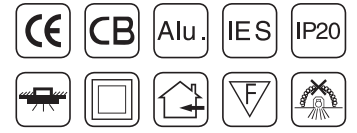

**LLS090**



**LLS089**

**PRODUCT PARAMETERS**

Model No.	Power	LED Chip	CRI	Lumens	CCT	Body Color	Beam Angle
LLS089	5W	DOB	≥80	450-500Lm	3000K/4000K	White / Black	60°
LLS090	5W	DOB	≥80	450-500Lm	3000K/4000K	White / Black	60°

**PRODUCT DIMENSION**

Unit (mm)

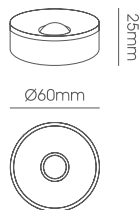

**LLS089-5W**  
Body Size:  
Ø60\*25mm

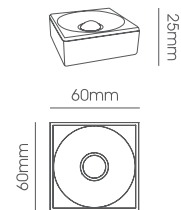

**LLS090-5W**  
Body Size:  
60\*60\*25mm



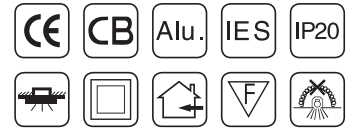

LLS102



LLS103

PRODUCT PARAMETERS



Model No.	Power	LED Chip	CRI	Lumens	CCT	Body Color	Beam Angle
LLS102	10W	BRIDGELUX SMD	≥90	470-770Lm	3000K/4000K	Sand White / Matt Black	36°
LLS103	10W	BRIDGELUX SMD	≥90	535-620Lm	3000K/4000K	Sand White / Matt Black	36°

PRODUCT DIMENSION

Unit (mm)

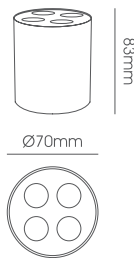

LLS102-10W  
Body Size:  
Ø70\*83mm

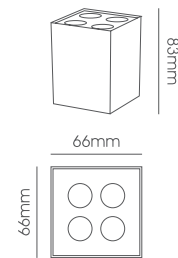

LLS103-10W  
Body Size:  
66\*66\*83mm

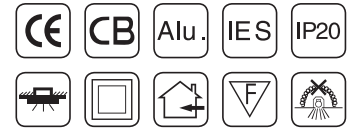

**PRODUCT PARAMETERS**



Model No.	Power	LED Chip	CRI	Lumens	CCT	Body Color	Beam Angle
LLS099	3W	CREE COB	≥80	260Lm	3000K/4000K	White / Black	36°
LLS100	7W	CREE COB	≥80	560Lm	3000K/4000K	White / Black	36°
LLS101	12W	CREE COB	≥80	960Lm	3000K/4000K	White / Black	36°

**PRODUCT DIMENSION**

Unit (mm)



Ø46mm



**LLS099-3W**  
Body Size:  
Ø46\*57mm

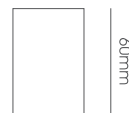

Ø55mm



**LLS100-7W**  
Body Size:  
Ø55\*60mm

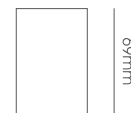

Ø68mm



**LLS101-12W**  
Body Size:  
Ø68\*69mm

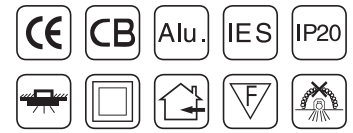

LLS 120 (COB)



LLS 121 (COB)



LLS 122 (COB)



LLS 123 (COB)

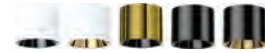

PRODUCT PARAMETERS



Model No.	Power	LED Chip	CRI	Lumens	CCT	Body Color	Beam Angle
LLS 120 (COB)	7W	COB-CREE	≥90	595Lm	3000K/4000K/5000K/6000k	White / Black	38°
LLS 121 (COB)	12W	COB-CREE	≥90	1020Lm	3000K/4000K/5000K/6000k	White / Black	38°
LLS 122 (COB)	18W	COB-CREE	≥90	1530Lm	3000K/4000K/5000K/6000k	White / Black	38°
LLS 123 (COB)	24W	COB-CREE	≥90	2040Lm	3000K/4000K/5000K/6000k	White / Black	38°

PRODUCT DIMENSION

Unit(mm)

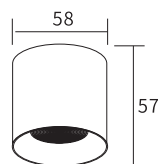

LLS 120(COB)-7W  
Body Size :Ø58\*57

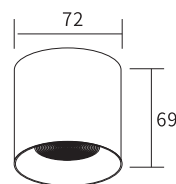

LLS 121(COB)-12W  
Body Size :Ø72\*69

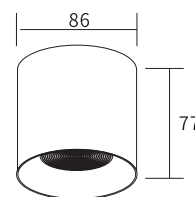

LLS 122(COB)-18W  
Body Size :Ø86\*77

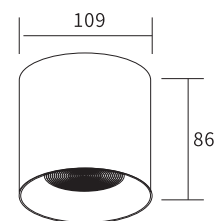

LLS 123(COB)-24W  
Body Size :Ø109\*86

# COB/SURFACE LIGHT FIXTURES

## SERIES

Driving Different Scenarios  
When creating highlights, also being illuminated by them

APPLICATION SCENARIO

office

hotel

family

## COB/SURFACE LIGHT FIXTURES

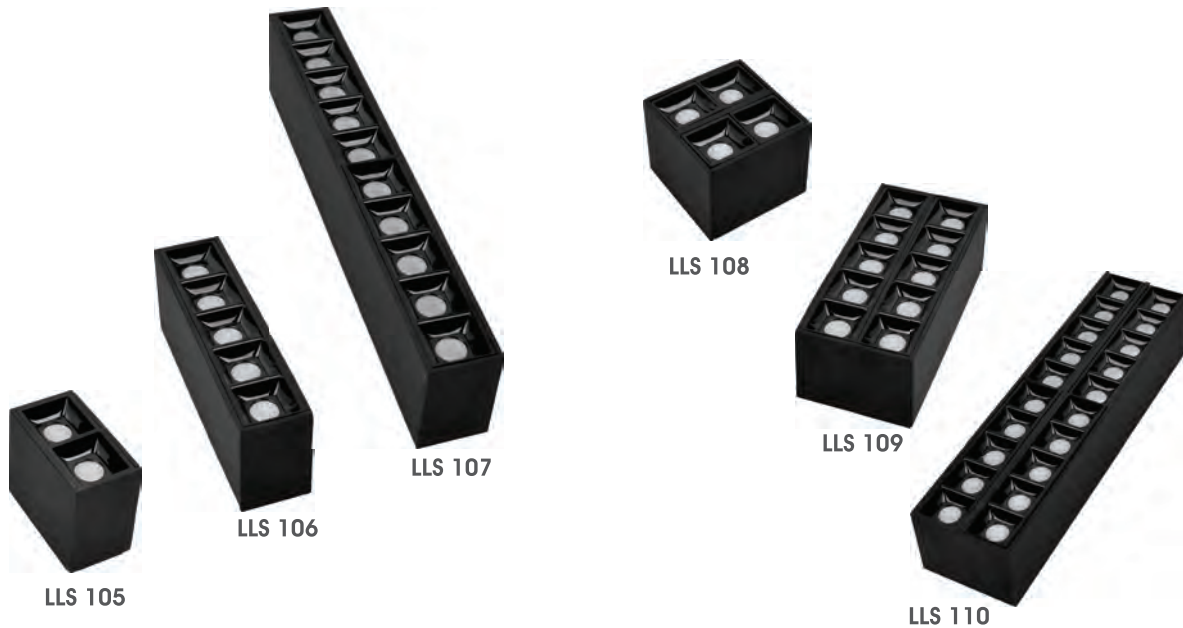
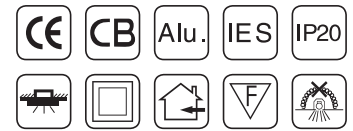

### PRODUCT PARAMETERS



Model No.	Power	LED Chip	CRI	Lumens	CCT	Body Color	Beam Angle
LLS 105	2*1.5W	Bridgelux	≥80	240Lm	3000K/4000K	White / Sand Black	30°
LLS 106	5*1.5W	Bridgelux	≥80	600Lm	3000K/4000K	White / Sand Black	30°
LLS 107	10*1.5W	Bridgelux	≥80	1200Lm	3000K/4000K	White / Sand Black	30°
LLS 108	4*1.5W	Bridgelux	≥80	480Lm	3000K/4000K	White / Sand Black	30°
LLS 109	10*1.5W	Bridgelux	≥80	1200Lm	3000K/4000K	White / Sand Black	30°
LLS 110	20*1.5W	Bridgelux	≥80	2400Lm	3000K/4000K	White / Sand Black	30°

### PRODUCT DIMENSION

Unit(mm)

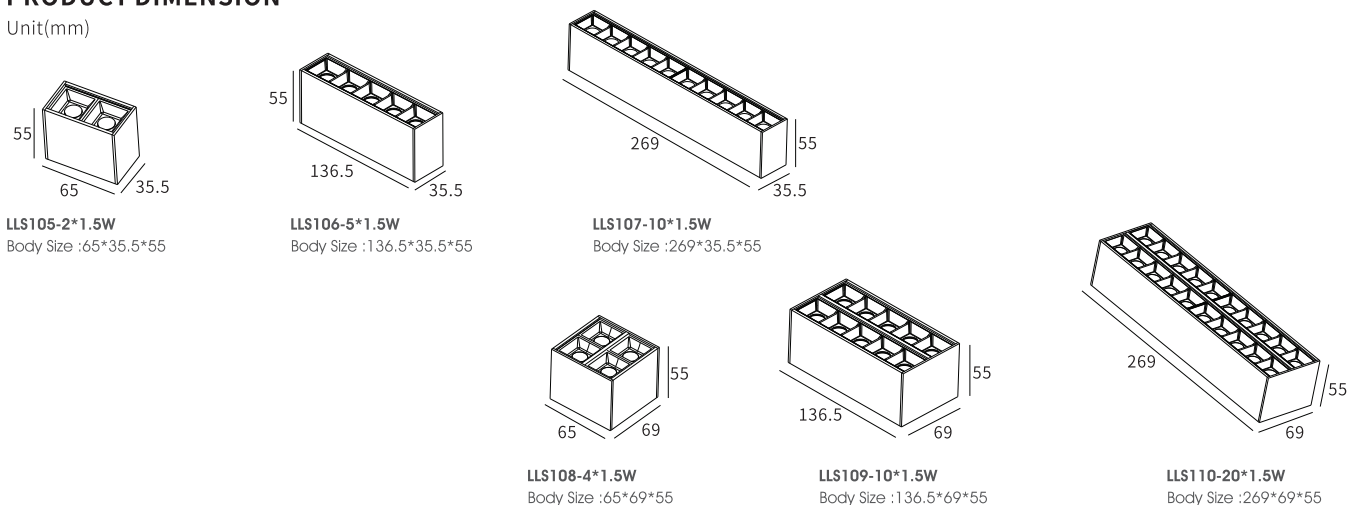



# LED COB SURFACE LIGHT FIXTURES

SERIES

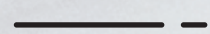

Driving Different Scenarios  
When creating highlights, also being illuminated by them



## LED COB SURFACE LIGHT FIXTURES

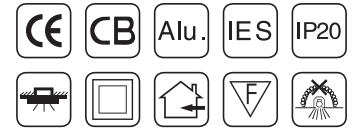

### PRODUCT PARAMETERS



Model No.	Power	LED Chip	CRI	Lumens	CCT	Body Color	Beam Angle
LLS 115	3W	CREE	≥90	255Lm	3000K/4000K/5000K/6000K	White / Black	38°
LLS 116	7W	CREE	≥90	595Lm	3000K/4000K/5000K/6000K	White / Black	38°
LLS 117	12W	CREE	≥90	1020Lm	3000K/4000K/5000K/6000K	White / Black	38°
LLS 118	20W	CREE	≥90	1700Lm	3000K/4000K/5000K/6000K	White / Black	38°
LLS 119	30W	CREE	≥90	2550Lm	3000K/4000K/5000K/6000K	White / Black	38°

### PRODUCT DIMENSION

Unit(mm)

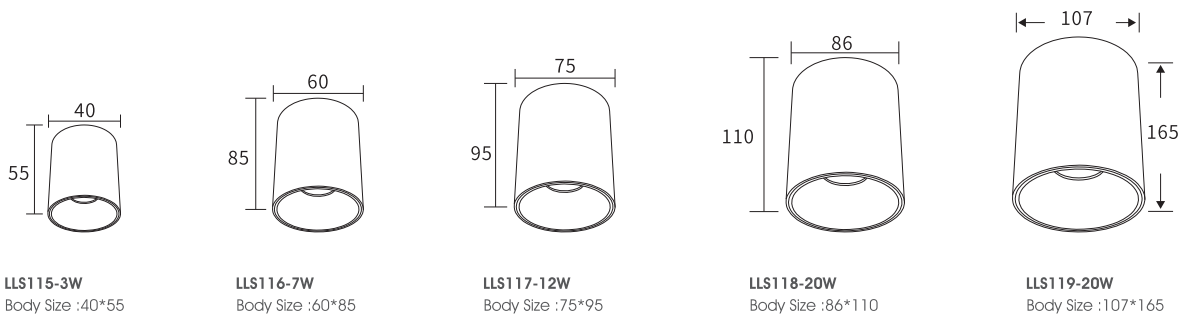

# LED COB SURFACE LIGHT FIXTURES

## SERIES

Multiple color combinations available  
Bright enough, versatile enough

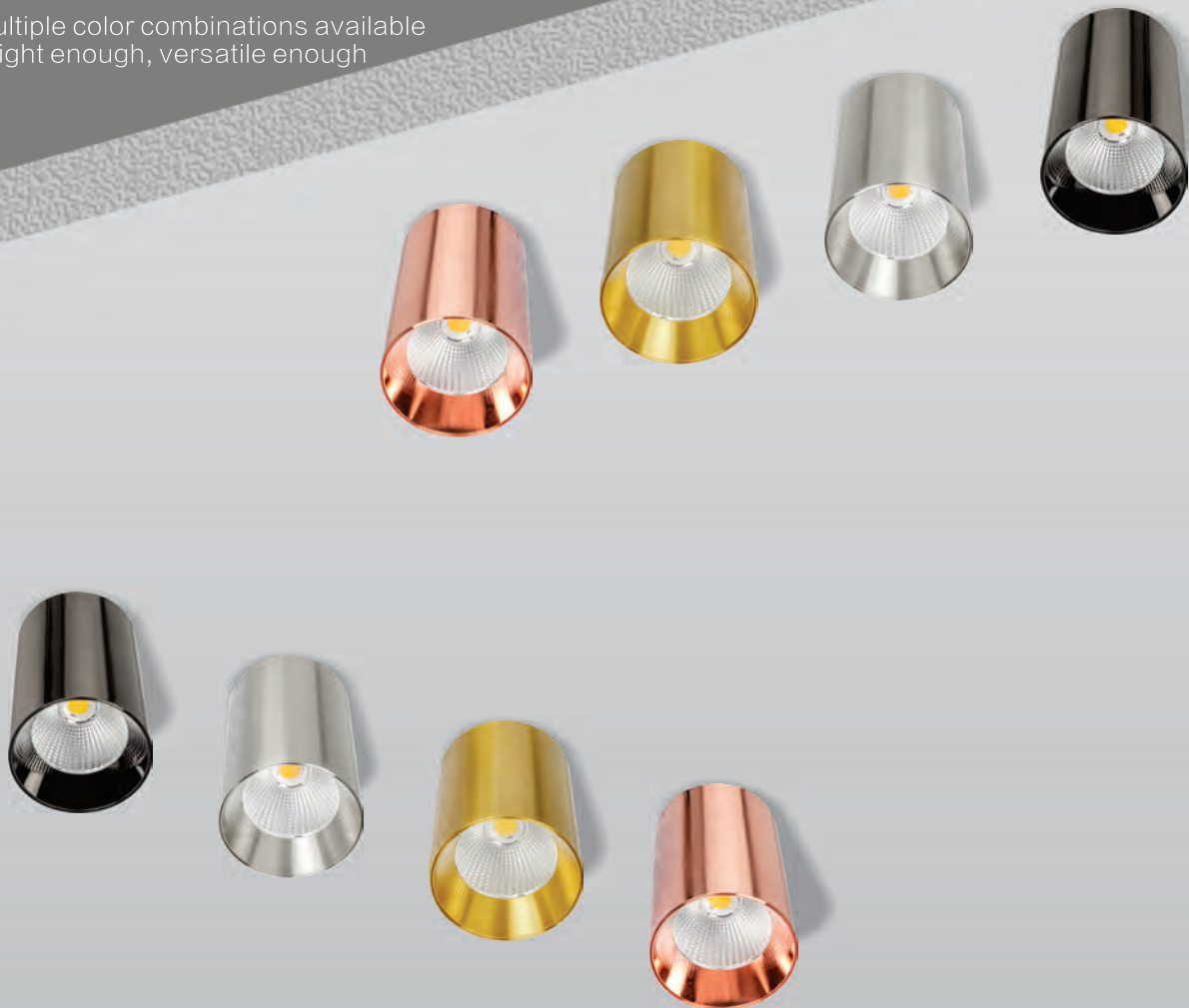

### APPLICATION SCENARIO

office

a living room

exhibition hall

## LED COB SURFACE LIGHT FIXTURES

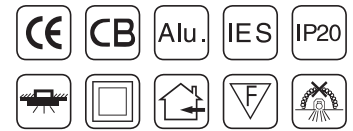

Body color



LLS 124

LLS 125

LLS 126

### PRODUCT PARAMETERS



Model No.	Power	LED Chip	CRI	Lumens	CCT	Body Color	Beam Angle
LLS 124	7W	CREE	≥90	595Lm	3000K/4000K/5700K	White / Black / Gold / Satin / Rose Gold / Gun Black	40°
LLS 125	12W	CREE	≥90	1020Lm	3000K/4000K/5700K	White / Black / Gold / Satin / Rose Gold / Gun Black	40°
LLS 126	18W	CREE	≥90	1530Lm	3000K/4000K/5700K	White / Black / Gold / Satin / Rose Gold / Gun Black	40°

### PRODUCT DIMENSION

Unit(mm)

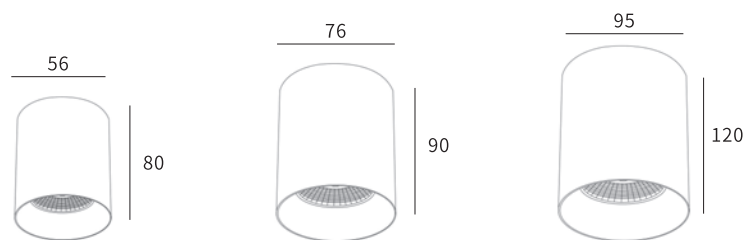

LLS124-7W  
Body Size :∅56\*80

LLS125-12W  
Body Size :∅76\*90

LLS126-18W  
Body Size :∅95\*120

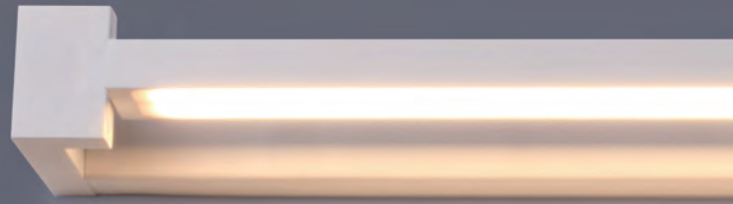



LED LIGHTING  
WALL LIGHT SERIES

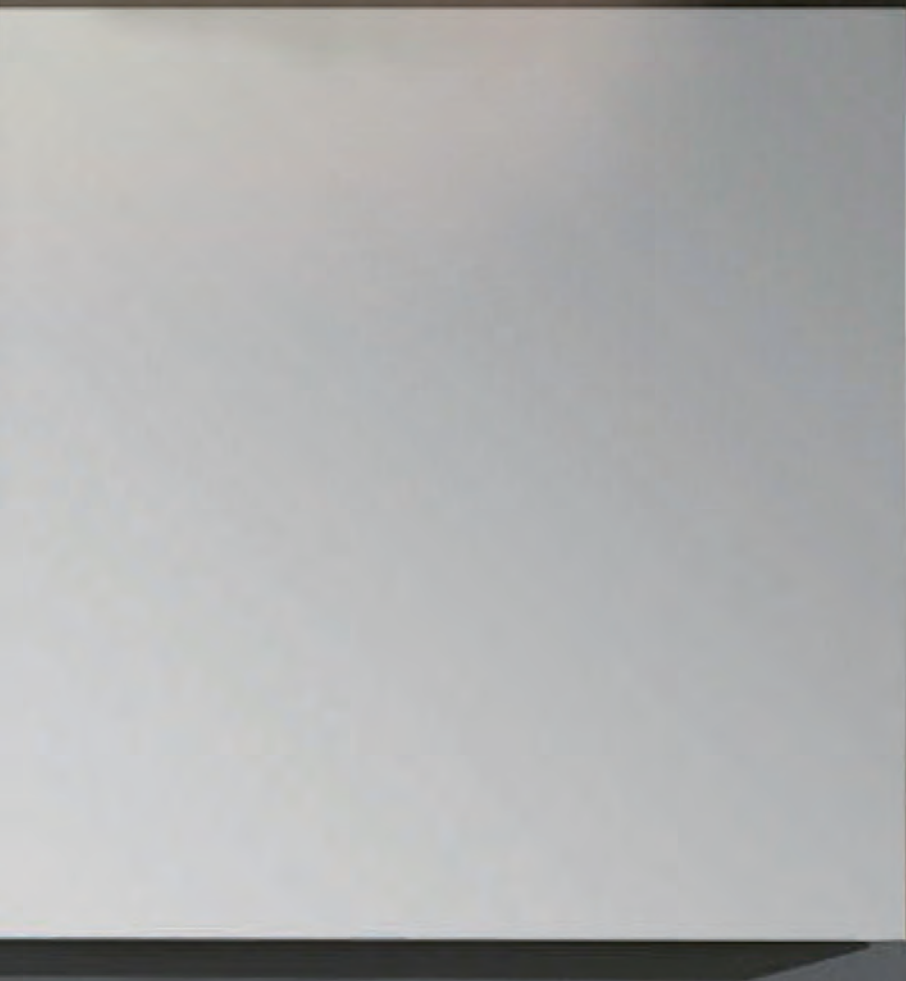
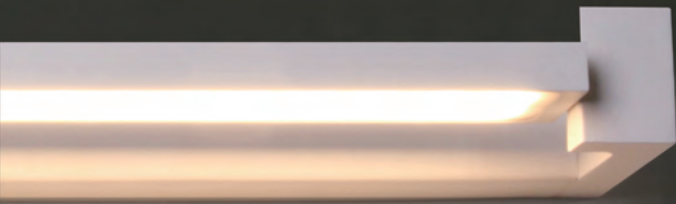

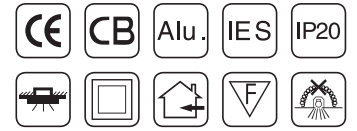

LLWL001



LLWL002



LLWL003



LLWL004

**PRODUCT PARAMETERS**

**EPISTAR**

Model No.	Power	LED Chip	CRI	Lumens	CCT	Body Color	Beam Angle
LLWL001	1*1W	EPISTAR SMD	≥80	80Lm/W	3000K	White / Black	60°
LLWL002	2*1W	EPISTAR SMD	≥80	80Lm/W	3000K	White / Black	60°
LLWL003	1*1W	EPISTAR SMD	≥80	80Lm/W	3000K	White / Black	90°
LLWL004	2*1W	EPISTAR SMD	≥80	80Lm/W	3000K	White / Black	90°

**PRODUCT DIMENSION**

Unit (mm)

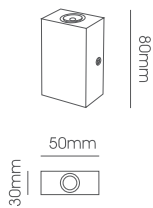

LLWL001-1\*1W(ONE WAY)  
Body Size:  
50\*30\*80mm

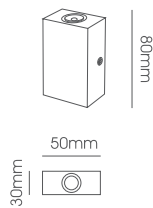

LLWL002-2\*1W(TWO WAY)  
Body Size:  
50\*30\*80mm

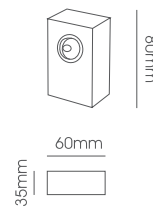

LLWL003-1\*1W(ONE WAY)  
Body Size:  
60\*35\*80mm

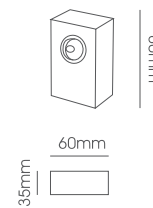

LLWL004-2\*1W(TWO WAY)  
Body Size:  
60\*35\*80mm



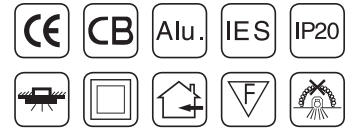

LLWL005



LLWL006

PRODUCT PARAMETERS

EPISTAR

Model No.	Power	LED Chip	CRI	Lumens	CCT	Body Color	Beam Angle
LLWL005	1*5W	EPISTAR SMD	≥80	80Lm/W	3000K	White	90°
LLWL006	2*5W	EPISTAR SMD	≥80	80Lm/W	3000K	White	90°

PRODUCT DIMENSION

Unit (mm)

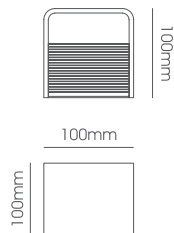

LLWL005-1\*5W  
Body Size:  
100\*100\*100mm

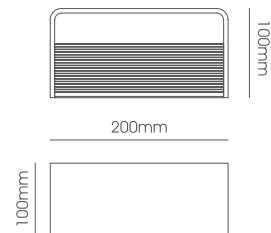

LLWL006-2\*5W  
Body Size:  
200\*100\*100mm

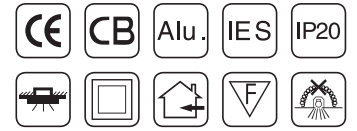

**LLWL020**



**LLWL021**

**PRODUCT PARAMETERS**

**EPISTAR**

Model No.	Power	LED Chip	CRI	Lumens	CCT	Body Color	Beam Angle
LLWL020	12W	EPISTAR SMD	≥80	80Lm/W	3000K	White	360°
LLWL021	8W	EPISTAR SMD	≥80	80Lm/W	3000K	White	360°

**PRODUCT DIMENSION**

Unit (mm)

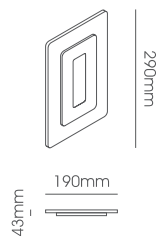

**LLWL020-12W**  
Body Size:  
290\*190\*43mm

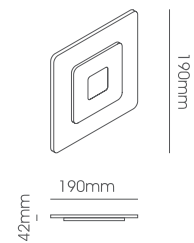

**LLWL021-8W**  
Body Size:  
190\*190\*42mm

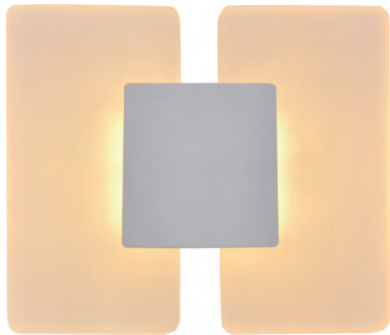
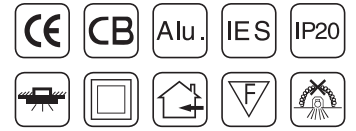

LLWL022/LLWL022A

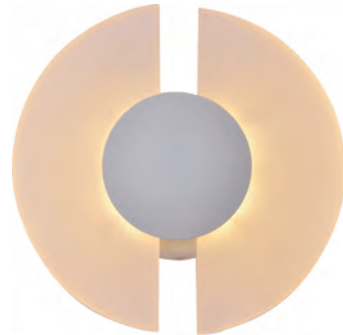

LLWL023/LLWL024

PRODUCT PARAMETERS



Model No.	Power	LED Chip	CRI	Lumens	CCT	Body Color	Beam Angle
LLWL022	4*3W	EDISON SMD	≥80	80Lm/W	3000K	White	120°
LLWL022A	2*3W	EDISON SMD	≥80	80Lm/W	3000K	White	120°
LLWL023	2*3W	EDISON SMD	≥80	80Lm/W	3000K	White	120°
LLWL024	4*3W	EDISON SMD	≥80	80Lm/W	3000K	White	120°

PRODUCT DIMENSION

Unit (mm)

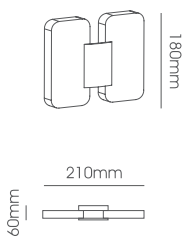

LLWL022-4\*3W  
Body Size:  
210\*180\*60mm

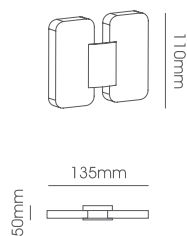

LLWL022A-2\*3W  
Body Size:  
135\*110\*50mm

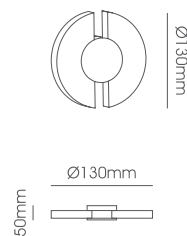

LLWL023-2\*3W  
Body Size:  
Ø130\*50mm

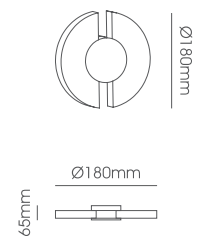

LLWL024-4\*3W  
Body Size:  
Ø180\*65mm

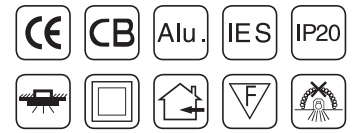

**LLWL056**

**LLWL057**

**LLWL058**

**PRODUCT PARAMETERS**



Model No.	Power	LED Chip	CRI	Lumens	CCT	Body Color	Beam Angle
LLWL056	8W	EDISON SMD	≥80	655Lm	3000K	White	UP/Down
LLWL057	16W	EDISON SMD	≥80	1178Lm	3000K	White	UP/Down
LLWL058	24W	EDISON SMD	≥80	1760Lm	3000K	White	UP/Down

**PRODUCT DIMENSION**

Unit (mm)

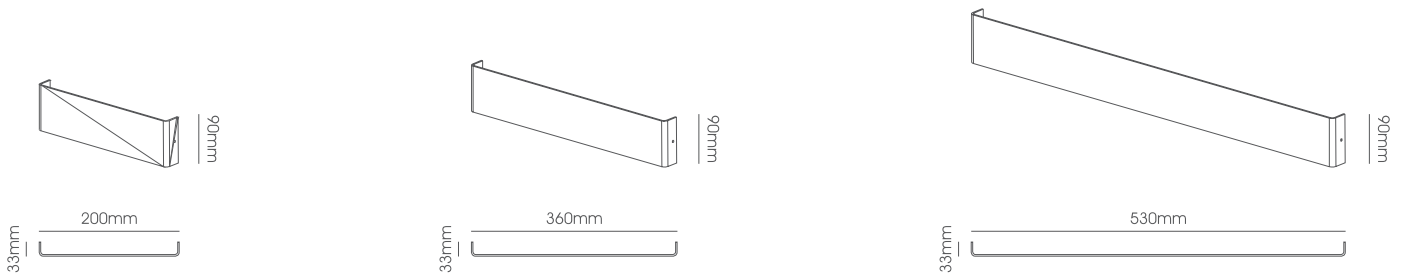

**LLWL056-8W**  
Body Size:  
200\*90\*33mm

**LLWL057-16W**  
Body Size:  
360\*90\*33mm

**LLWL058-24W**  
Body Size:  
530\*90\*33mm

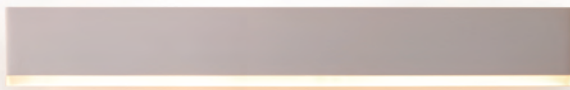
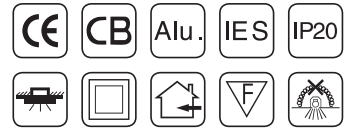

LLWL060-LLWL060A



LLWL061-LLWL061A

PRODUCT PARAMETERS

EPISTAR

Model No.	Power	LED Chip	CRI	Lumens	CCT	Body Color	Beam Angle
LLWL060	8W	EPISTAR SMD	≥80	528Lm	3000K	White	One Way
LLWL060A	12W	EPISTAR SMD	≥80	840Lm	3000K	White	One Way
LLWL061	16W	EPISTAR SMD	≥80	1047Lm	3000K	White	UP/Down
LLWL061A	24W	EPISTAR SMD	≥80	1920Lm	3000K	White	UP/Down

PRODUCT DIMENSION

Unit (mm)

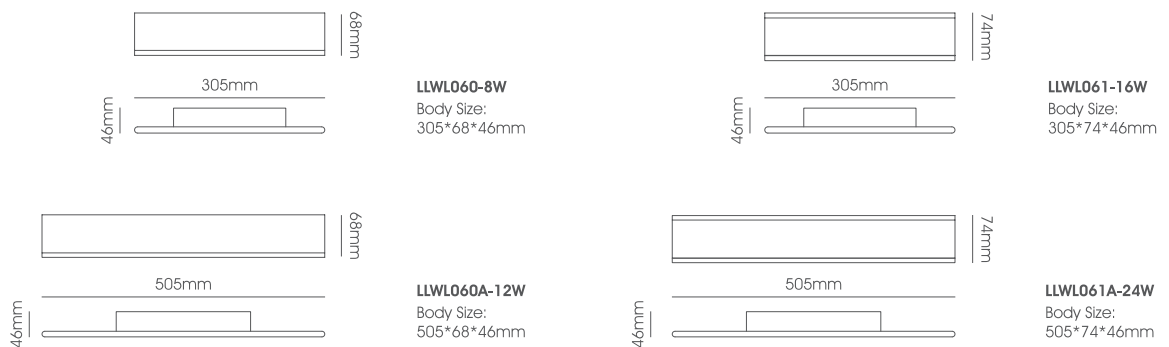

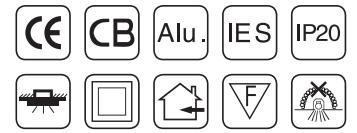

**LLWL088**



**LLWL090**

**PRODUCT PARAMETERS**



Model No.	Power	LED Chip	CRI	Lumens	CCT	Body Color	Beam Angle
LLWL088	12W	EDISON SMD	≥80	900Lm	3000K	White	120°
LLWL090	20W	EDISON SMD	≥80	1810Lm	3000K	White	160°

**PRODUCT DIMENSION**

Unit (mm)

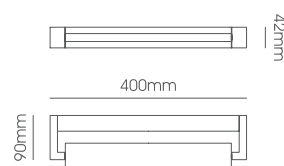

**LLWL088-12W**  
Body Size:  
400\*90\*42mm

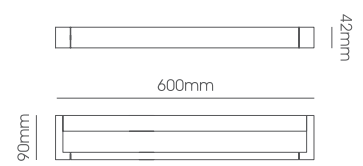

**LLWL090-20W**  
Body Size:  
600\*90\*42mm



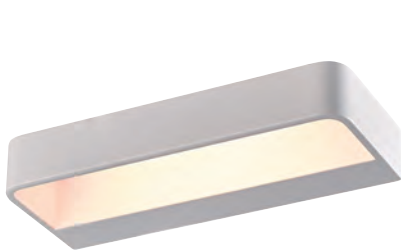
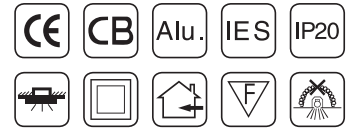

LLWL098



LLWL099

PRODUCT PARAMETERS

EVERLIGHT

Model No.	Power	LED Chip	CRI	Lumens	CCT	Body Color	Beam Angle
LLWL098	6W	EVERLIGHT SMD	≥90	442Lm	3000K/4000K	White	120°
LLWL099	12W	EVERLIGHT SMD	≥90	1045Lm	3000K/4000K	White	120°

PRODUCT DIMENSION

Unit (mm)



LLWL098-6W  
Body Size:  
230\*36\*90mm



LLWL099-12W  
Body Size:  
380\*36\*90mm

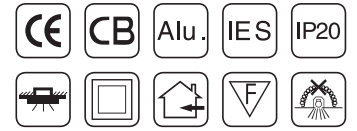

**PRODUCT PARAMETERS**



Model No.	Power	LED Chip	CRI	Lumens	CCT	Body Color	Beam Angle
LLWL100	4W	SANAN SMD	≥80	/	3000K	Gold	120°
LLWL101	8W	SANAN SMD	≥80	/	3000K	Gold	120°

**PRODUCT DIMENSION**

Unit (mm)



Ø160mm

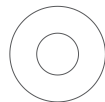

**LLWL100-6W**  
Body Size:  
Ø160\*107mm



Ø200mm

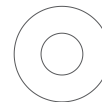

**LLWL101-12W**  
Body Size:  
Ø200\*112mm

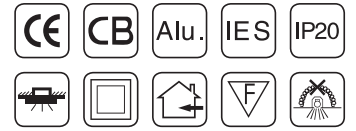

LLWL103



LLWL104



LLWL105

PRODUCT PARAMETERS



Model No.	Power	LED Chip	CRI	Lumens	CCT	Body Color	Beam Angle
LLWL103	3W+6W	CREE XPE+EPISTAR SMD	≥80	270Lm	3000K	White	38°
LLWL104	3W	CREE XPE	≥80	240Lm	3000K	Black / BGD	38°
LLWL105	3W	CREE XPE	≥80	240Lm	3000K	Black / BGD	38°

PRODUCT DIMENSION

Unit (mm)

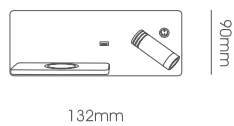

LLWL103-3W+6W  
Body Size:  
132\*90mm

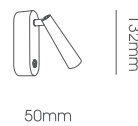

LLWL104-3W  
Body Size:  
132\*50mm



LLWL105-3W  
Body Size:  
139\*170mm

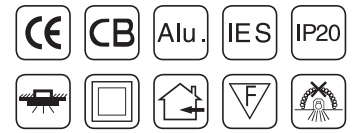

**LLWL046**



**LLWL047**



**LLWL048**

**PRODUCT PARAMETERS**



Model No.	Power	LED Chip	CRI	Lumens	CCT	Body Color	Beam Angle
LLWL046	3W	BRIDGELUX COB	≥80	300-310Lm	3000K/6500K	White	60°
LLWL047	3W	BRIDGELUX COB	≥80	300-310Lm	3000K/6500K	Black / White	60°
LLWL048	3W	BRIDGELUX COB	≥80	300-310Lm	3000K/6500K	White	60°

**PRODUCT DIMENSION**

Unit (mm)

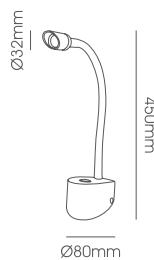

**LLWL046-3W**  
Body Size:  
Ø32\*Ø80\*450mm

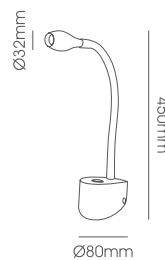

**LLWL047-3W**  
Body Size:  
Ø32\*Ø80\*450mm

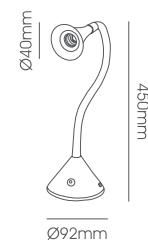

**LLWL048-3W**  
Body Size:  
Ø40\*Ø92\*450mm

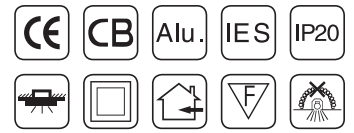

## PRODUCT PARAMETERS



Model No.	Power	LED Chip	CRI	Lumens	CCT	Body Color	Beam Angle
LLWL048A	3W	CREE COB	≥80	300-310Lm	3000K/6000K	White	60°
LLWL048B	6W	CREE COB	≥80	540-600Lm	3000K/6000K	White	60°
LLWL048C	9W	CREE COB	≥80	810-900Lm	3000K/6000K	White	60°

## PRODUCT DIMENSION

Unit (mm)

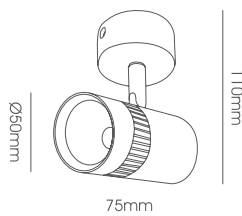

**LLWL048A-3W**  
Body Size:  
Ø50\*75\*110mm

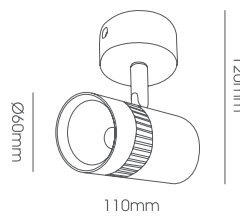

**LLWL048B-6W**  
Body Size:  
Ø60\*110\*120mm

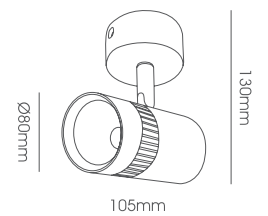

**LLWL048C-9W**  
Body Size:  
Ø80\*105\*130mm

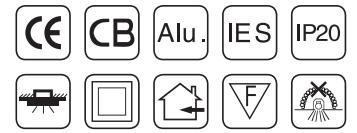

**PRODUCT PARAMETERS**



Model No.	Power	LED Chip	CRI	Lumens	CCT	Body Color	Beam Angle
LLWL102	7W	BRIDGELUX COB	≥90	455Lm	3000K	White / Black	38°

**PRODUCT DIMENSION**

Unit (mm)



**LLWL102-7W**  
Body Size:  
Ø70\*1200mm



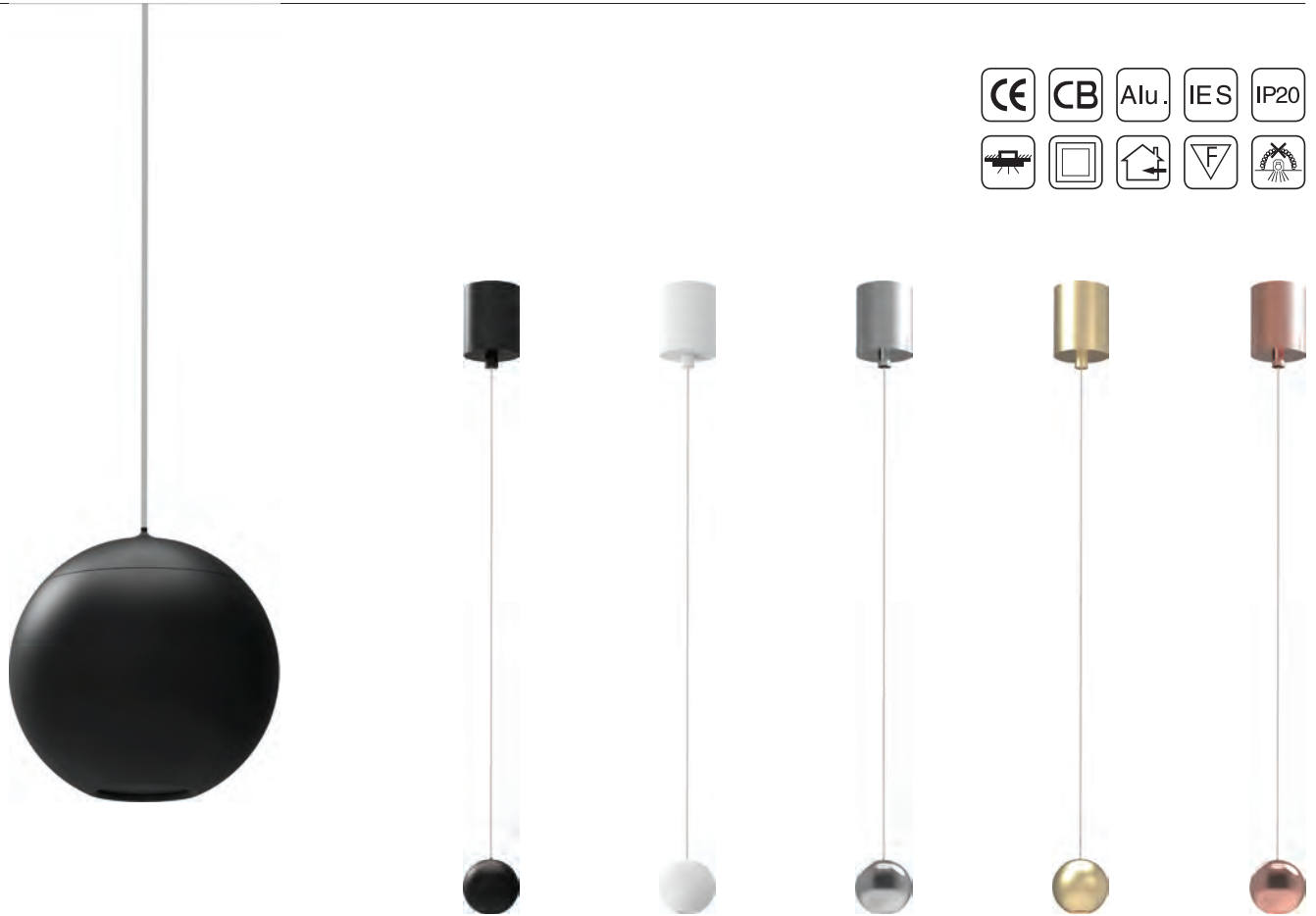
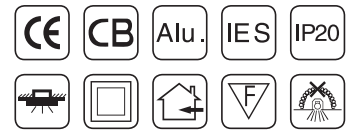

PRODUCT PARAMETERS



Model No.	Power	LED Chip	CRI	Lumens	CCT	Body Color	Beam Angle
LLWL106	6W	Osram 1202	≥90	515-555Lm	3000K	Sand Black / Sand White / Rose Gold / Copper	36°

PRODUCT DIMENSION

Unit (mm)



LLWL106-6W  
Body Size:  
Ø55\*1270mm

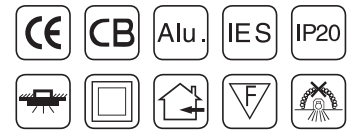

**PRODUCT PARAMETERS**



Model No.	Power	LED Chip	CRI	Lumens	CCT	Body Color	Beam Angle
LLWL107	10W	Osram 2835	≥90	830-960Lm	3000K	Sand Black / Sand White / Rose Gold / Copper	120°

**PRODUCT DIMENSION**

Unit (mm)



**LLWL107-10W**  
Body Size:  
Ø90\*1270mm



PRODUCT PARAMETERS



Model No.	Power	LED Chip	CRI	Lumens	CCT	Body Color	Beam Angle
LLWL108	10W	Osram 1202	≥90	615-650Lm	3000K	Sand Black / Sand White	36°

PRODUCT DIMENSION

Unit (mm)

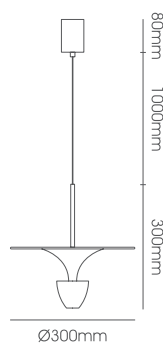

LLWL108-10W  
Body Size:  
Ø300\*1380mm

# MOTION/DOOR/ TOUCH SENSOR'S SERIES

Human body induction light  
When people come, they shine; when people leave, they perish



## APPLICATION SCENARIO

office

hotel

family

## MOTION/DOOR/TOUCH SENSOR'S

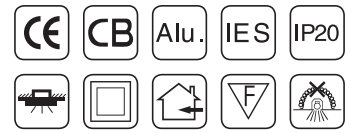

LMS 001



LMS 002

### PRODUCT PARAMETERS

Model No.	Power	LED Chip	CRI	Lumens	CCT	Body Color	Beam Angle
LMS 001	1200W/300W	/	/	/	/	White	360°
LMS 002	1200W/800W/300W/200W	/	/	/	/	White	360°

### PRODUCT DIMENSION

Unit(mm)

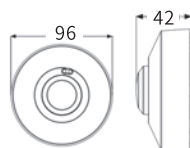

LMS 001-1200W/300W  
Body Size : $\varnothing$ 96\*42

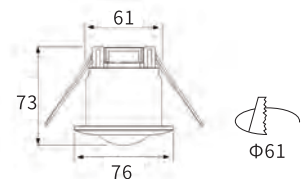

LMS 002-1200W/800W/300W/200W  
Body Size : $\varnothing$ 76\*73

## MOTION/DOOR/TOUCH SENSOR'S

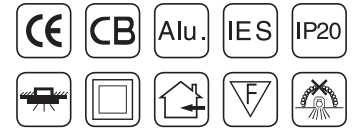

**LMS 003**  
SINGLE DOOR SENSOR



**LMS 004**  
MOTION SENSOR



**LMS 005**  
DOUBLE DOOR SEWSON



**LMS 006**  
MOTION SENSOR WITH BATTERY - RECHARGEABLE



**LMS 007**  
MOTION SENSOR WITH BATTERY - RECHARGEABLE

### PRODUCT PARAMETERS

Model No.	Power	Dimension (mm)	Cut-Out (mm)	Material	Beam Angle	Sense Distance	Body Color	IP
LMS 003	/	27.5*30*15	12	APS	360°	2-5CM	Grey	IP20
LMS 004	/	27.5*30*15	12	APS	360°	2-5CM	Grey	IP20
LMS 005	/	27.5*30*15	12	APS	360°	2-5CM	Grey	IP20
LMS 006	/	62*42*16	/	APS	360°	2-5CM	Grey	IP20
LMS 007	/	63*42*15	/	APS	360°	/	Grey	IP20





## DRIVER'S FOR SENSORS

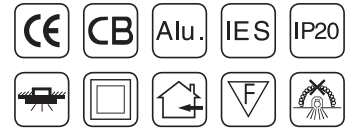

LMS 008



LMS 009



LMS 010



LMS 011

### PRODUCT PARAMETERS

Model No.	Power	Dimension (mm)	Cut-Out (mm)	Material	Beam Angle	Sense Distance	Body Color	IP
LMS 008	36W	138*55*18	/	APS	/	/	White	IP20
LMS 009	60W	188*55*18	/	APS	/	/	White	IP20
LMS 010	100W	248*60*18	/	APS	/	/	White	IP20
LMS 011	150W	225*74*25	/	APS	/	/	White	IP20





LED TUBE LIGHT FIXTURE SERIES





PRODUCT PARAMETERS

EPISTAR

Model No.	Power	LED Chip	CRI	Lumens	CCT	Body Color	Beam Angle
LLT006	8W	EPISTAR SMD	≥80	760-880Lm	3000K/4000K/6000K	White	100°
LLT007	15W	EPISTAR SMD	≥80	1425-1650Lm	3000K/4000K/6000K	White	100°
LLT008	30W	EPISTAR SMD	≥80	2850-3300Lm	3000K/4000K/6000K	White	100°

PRODUCT DIMENSION

Unit (mm)

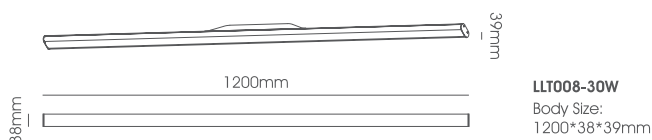
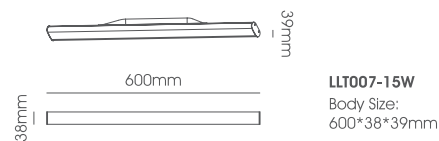
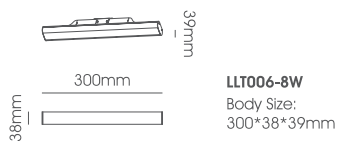

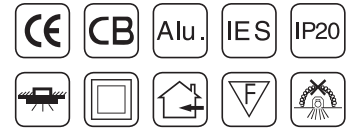

**PRODUCT PARAMETERS**

**EPISTAR**

Model No.	Power	LED Chip	CRI	Lumens	CCT	Body Color	Beam Angle
LLT009	10W	EPISTAR SMD	≥80	950-1100Lm	3000K/4000K/6000K	White	120°
LLT010	20W	EPISTAR SMD	≥80	1900-2200Lm	3000K/4000K/6000K	White	120°
LLT011	40W	EPISTAR SMD	≥80	3800-4400Lm	3000K/4000K/6000K	White	120°

**PRODUCT DIMENSION**

Unit (mm)

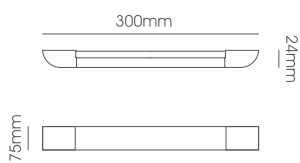

**LLT009-10W**  
Body Size:  
300\*75\*24mm

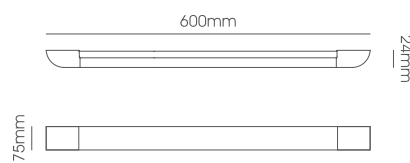

**LLT010-20W**  
Body Size:  
600\*75\*24mm

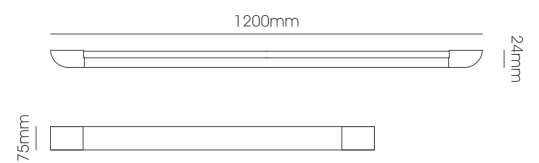

**LLT011-40W**  
Body Size:  
1200\*75\*24mm



PRODUCT PARAMETERS

EPISTAR

Model No.	Power	LED Chip	CRI	Lumens	CCT	Body Color	Beam Angle
LLT004	7W	EPISTAR SMD	≥80	665-770Lm	3000K/6000K	Sliver	120°
LLT005	12W	EPISTAR SMD	≥80	1140-1320Lm	3000K/6000K	Sliver	120°

PRODUCT DIMENSION

Unit (mm)

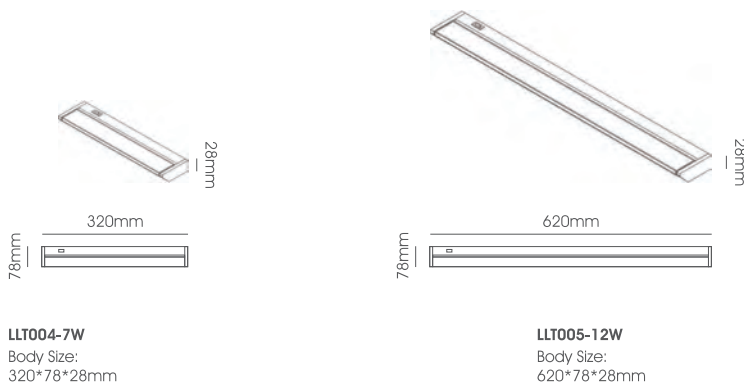

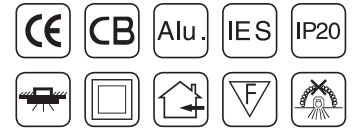

**PRODUCT PARAMETERS**

**EPISTAR**

Model No.	Power	LED Chip	CRI	Lumens	CCT	Body Color	Beam Angle
LLT026	8W	EPISTAR SMD	≥80	855-990Lm	3000K/4000K/6000K	White	120°
LLT027	15W	EPISTAR SMD	≥80	1425-1650Lm	3000K/4000K/6000K	White	120°
LLT028	30W	EPISTAR SMD	≥80	2280-2640Lm	3000K/4000K/6000K	White	120°

**PRODUCT DIMENSION**

Unit (mm)

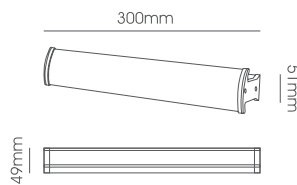

**LLT026-8W**  
Body Size:  
300\*49\*51mm

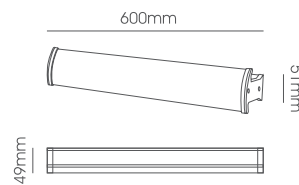

**LLT027-15W**  
Body Size:  
600\*49\*51mm

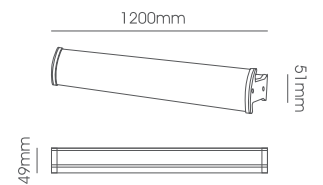

**LLT028-30W**  
Body Size:  
1200\*49\*51mm





PRODUCT PARAMETERS



Model No.	Power	LED Chip	CRI	Lumens	CCT	Body Color	Beam Angle
LLT032	4W	MLS SMD	≥70	220Lm	3000K/4000K/6000K	White	105°
LLT033	8W	MLS SMD	≥70	550Lm	3000K/4000K/6000K	White	105°
LLT034	12W	MLS SMD	≥70	800Lm	3000K/4000K/6000K	White	105°
LLT035	16W	MLS SMD	≥70	1100Lm	3000K/4000K/6000K	White	105°

PRODUCT DIMENSION

Unit (mm)

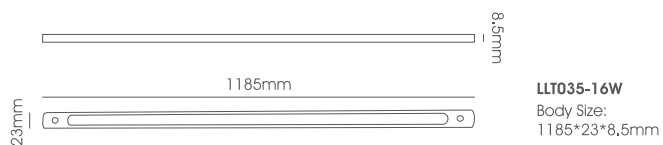
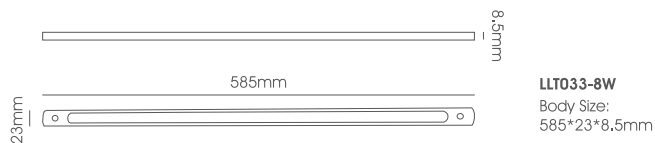





LLT-038/LLT-039

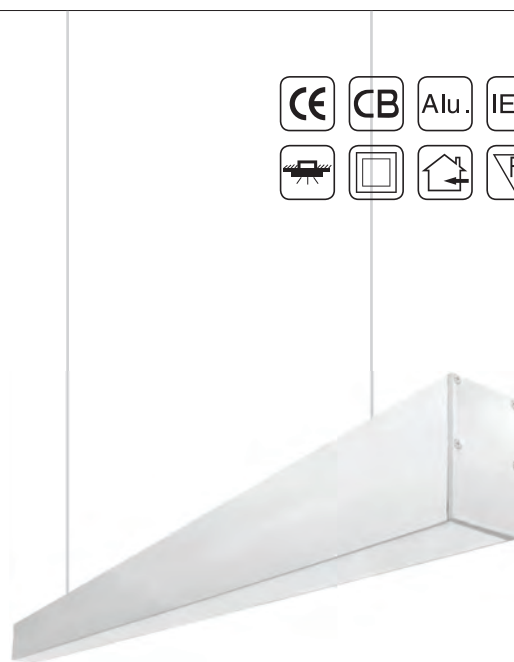

LLT-036/LLT-037



PRODUCT PARAMETERS

EPISTAR

Model No.	Power	LED Chip	CRI	Lumens	CCT	Body Color	Beam Angle
LLT036	25W	EPISTAR SMD	≥ 80	2100-2300lm	3000K/4000K/600K	White / Black	120°
LLT037	45W	EPISTAR SMD	≥ 80	3600-4050lm	3000K/4000K/600K	White / Black	120°
LLT038	25W	EPISTAR SMD	≥ 80	2100-2300lm	3000K/4000K/600K	White / Black	60°
LLT039	45W	EPISTAR SMD	≥ 80	3600-4050lm	3000K/4000K/600K	White / Black	60°

PRODUCT DIMENSION

Unit (mm)

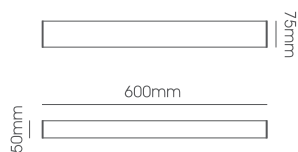

LLT036-25W  
Body Size:  
600\*50\*75mm

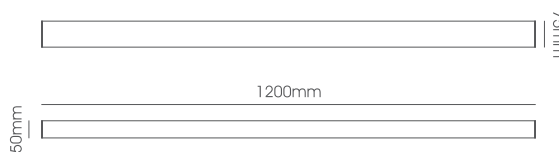

LLT037-45W  
Body Size:  
1200\*50\*75mm

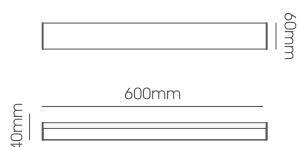

LLT038-25W  
Body Size:  
600\*40\*60mm



LLT039-45W  
Body Size:  
1200\*40\*60mm



**LED Lum**

Lighting.Simplified

---

**LED LIGHTING**  
**WALL LIGHT SERIES**



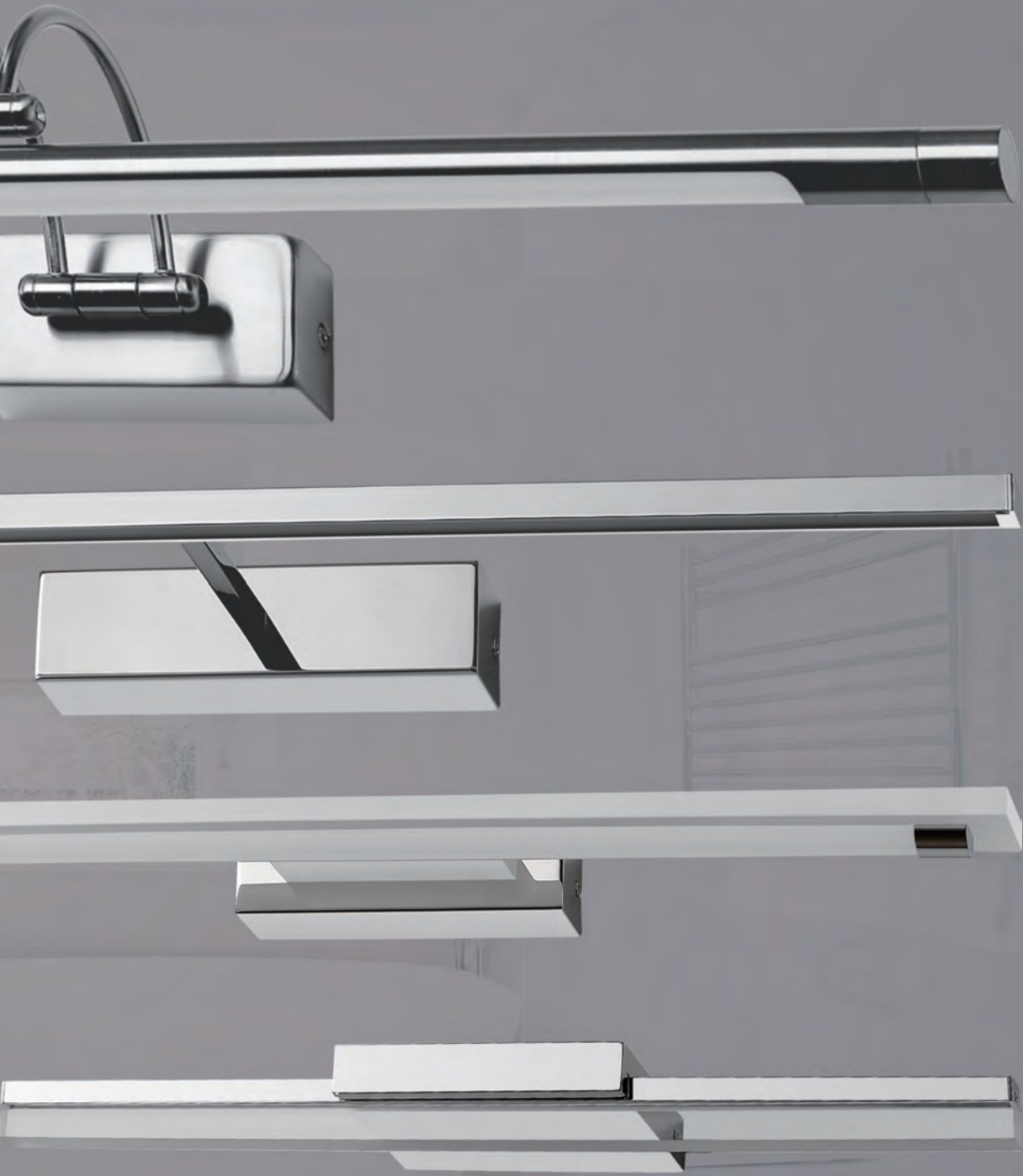





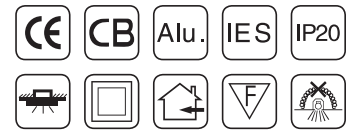

LLT012/LLT013



LLT014/LLT015

PRODUCT PARAMETERS

EPISTAR

Model No.	Power	LED Chip	CRI	Lumens	CCT	Body Color	Beam Angle
LLT012	5W	EPISTAR SMD	≥80	335Lm	3000K	Satin Nicke / Copper	120°
LLT013	12W	EPISTAR SMD	≥80	899Lm	3000K	Satin Nicke / Copper	120°
LLT014	5W	EPISTAR SMD	≥80	335Lm	3000K	Satin Nicke / Copper	120°
LLT015	12W	EPISTAR SMD	≥80	899Lm	3000K	Satin Nicke / Copper	120°

PRODUCT DIMENSION

Unit (mm)

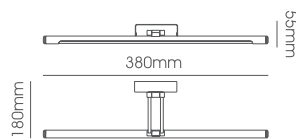

LLT012-5W  
Body Size:  
380\*180\*55mm

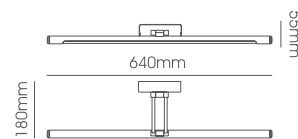

LLT013-12W  
Body Size:  
640\*180\*55mm

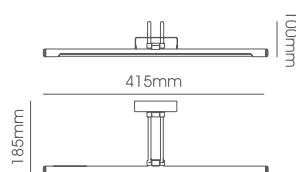

LLT014-5W  
Body Size:  
415\*185\*100mm

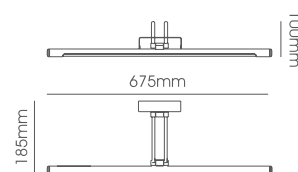

LLT015-12W  
Body Size:  
675\*185\*100mm



# LED LIGHTING

## WALL LIGHT SERIES



LLT016/LLT017



LLT018/LLT019



LLT020/LLT021

PRODUCT PARAMETERS

EPISTAR

Model No.	Power	LED Chip	CRI	Lumens	CCT	Body Color	Beam Angle
LLT016	8W	EPISTAR SMD	≥80	321Lm	3000K	Chrome	120°
LLT017	12W	EPISTAR SMD	≥80	554Lm	3000K	Chrome	120°
LLT018	8W	EPISTAR SMD	≥80	321Lm	3000K	Chrome	120°
LLT019	12W	EPISTAR SMD	≥80	554Lm	3000K	Chrome	120°
LLT020	8W	EPISTAR SMD	≥80	581Lm	3000K	Chrome	120°
LLT021	12W	EPISTAR SMD	≥80	910Lm	3000K	Chrome	120°

PRODUCT DIMENSION

Unit (mm)

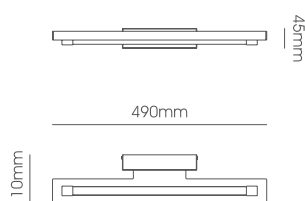

LLT016-8W  
Body Size:  
490\*110\*45mm

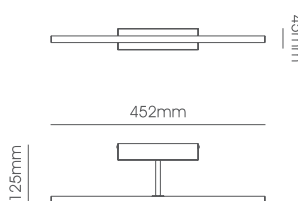

LLT018-8W  
Body Size:  
452\*125\*45mm

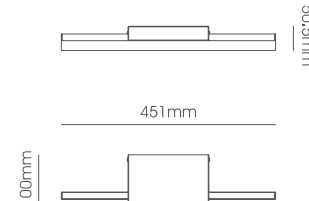

LLT020-8W  
Body Size:  
451\*100\*50,5mm

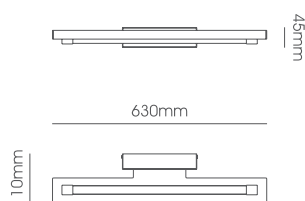

LLT017-12W  
Body Size:  
630\*110\*45mm

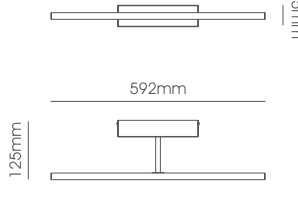

LLT019-12W  
Body Size:  
592\*125\*45mm

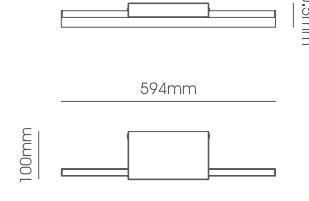

LLT021-12W  
Body Size:  
594\*100\*50,5mm

**LLP22/14**

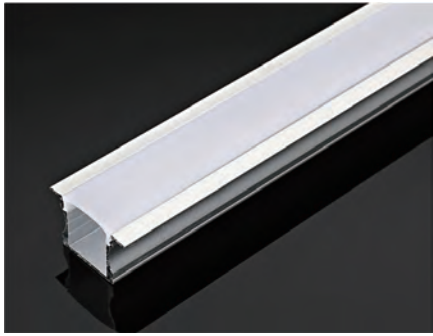

**LLP18/14**

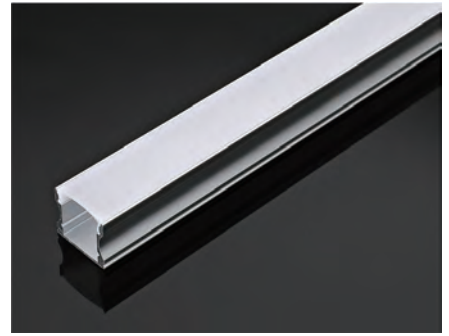
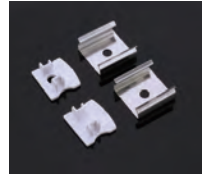

**LLP17.4/07**



**LLP7.8/9**

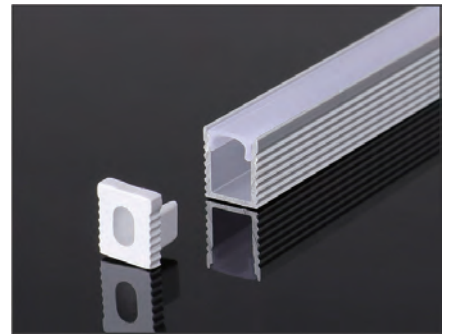
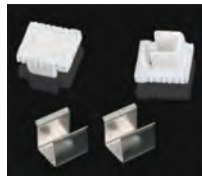

**PRODUCT PARAMETERS**

Model No.	Dimension	PCB	Size	End Caps	Clips
LLP22/14	L*24*14.2mm	12mm	2MT/3MT	2	2
LLP18/14	L*17,2*14,4mm	12mm	2MT/3MT	2	2
LLP17.4/07	L*17.4*7mm	12mm	2MT/3MT	2	2
LLP7.8/9	L*7,7*9mm	5mm	3MT	2	2

**PRODUCT DIMENSION**

Unit (mm)

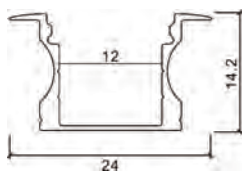

LLP22/14

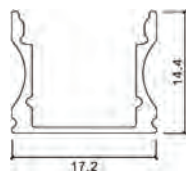

LLP18/14

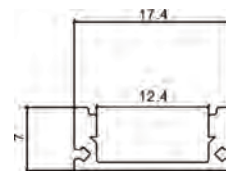

LLP17.4/07

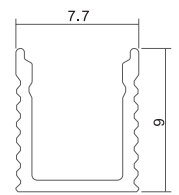

LLP7.7/9

LLP19/19

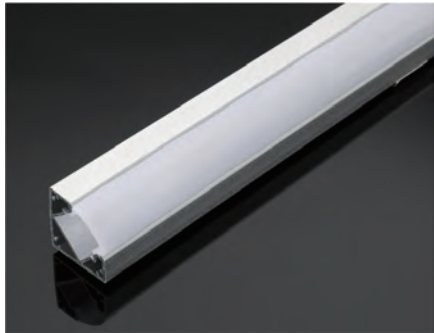

LLP20/07

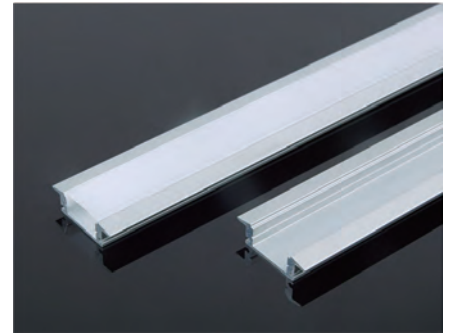

LLP23/9.8



LLP30/9.8



PRODUCT PARAMETERS

Model No.	Dimension	PCB	Size	End Caps	Clips
LLP19/19	L*19*19mm	12mm	2MT/3MT	2	2
LLP20/07	L*24.7*7mm	12mm	2MT/3MT	2	2
LLP23/9.8	L*23.5*9.8mm	21mm	2MT/3MT	2	2
LLP30/9.8	L*30.3*9.8mm	21mm	2MT/5MT	2	2

PRODUCT DIMENSION

Unit (mm)

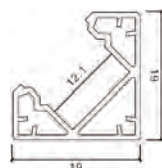

LLP19/19

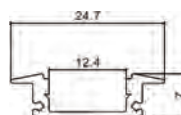

LLP20/07

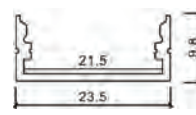

LLP23/9.8

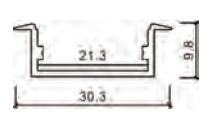

LLP30/9.8

**LLP44/35**

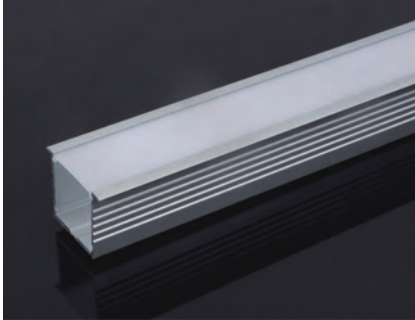

**LLP35/35**

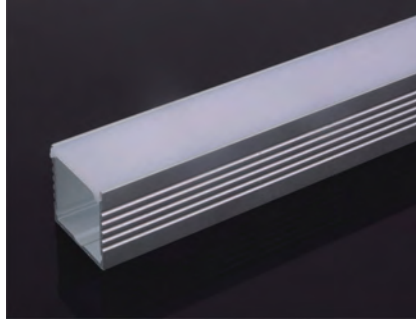

**LLP50/32**



**Groupware**

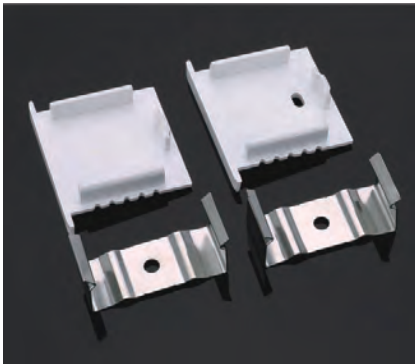

**Groupware**

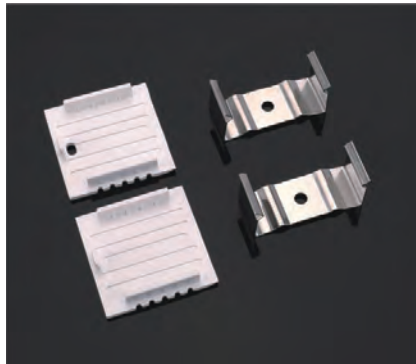

**Groupware**



**PRODUCT PARAMETERS**

Model No.	Dimension	PCB	Size	End Caps	Clips
LLP44/35	L*43,6*34,8mm	33mm	2,4MT	4	4
LLP35/35	L*35*34,8mm	33mm	2,4MT	4	4
LLP50/32	L*49*32mm	45mm	2,4MT	4	4

**PRODUCT DIMENSION**

Unit (mm)

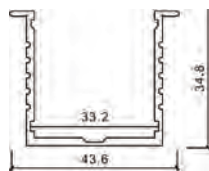

LLP44/35

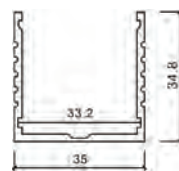

LLP35/35

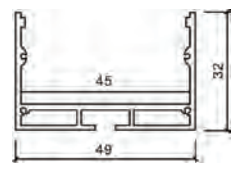

LLP50/32



LLP65/32

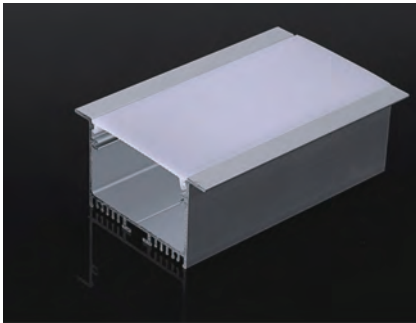

LLP90/35

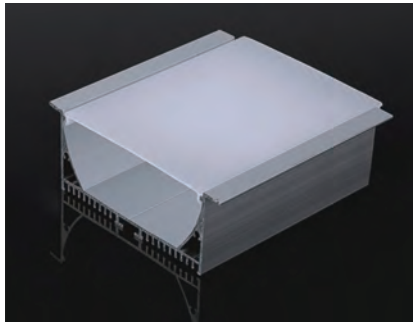

LLP42/90

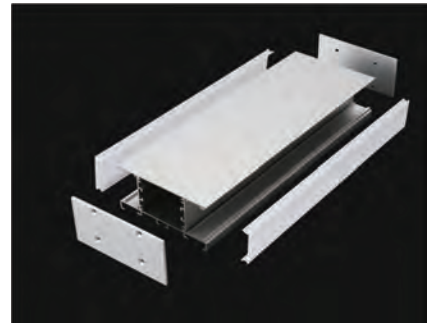

Groupware

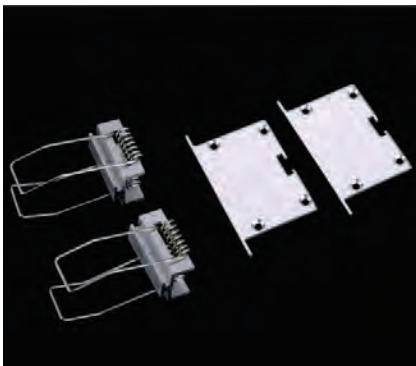

Groupware

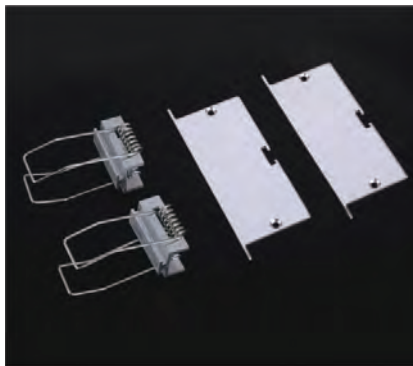

Groupware



PRODUCT PARAMETERS

Model No.	Dimension	PCB	Size	End Caps	Clips
LLP65/32	L*64,2*35mm	46,5mm	2,4MT	4	4
LLP90/35	L*90*35mm	50mm	2,4MT	4	4
LLP42/90	L*42*90mm	50mm	2,4MT	4	4

PRODUCT DIMENSION

Unit (mm)

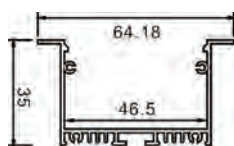

LLP65/32

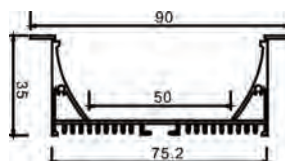

LLP90/35

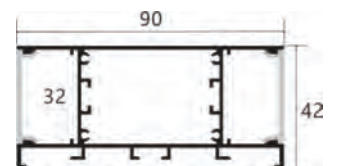

LLP42/90

# PROFILES

## SERIES

Easy installation, uniform lighting, and no dark areas  
Overall achieve the effect of seeing light but not light



PROFILES  
2MT/3MT Available

**LLP-24/14**

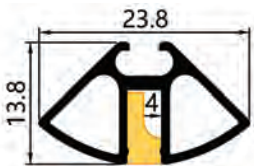
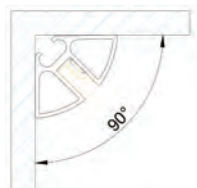

Color's-Sliver/Matt Black

dimension	installation diagram
	

**LLP-019**

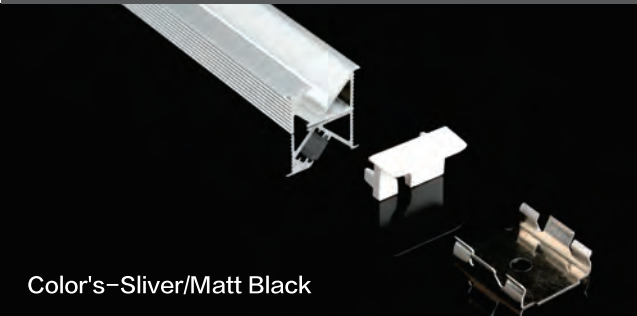

Color's-Sliver/Matt Black

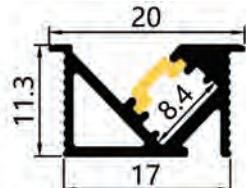
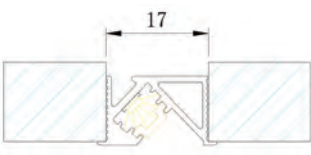
dimension	installation diagram
	

**LLP-36/28**

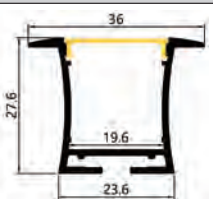
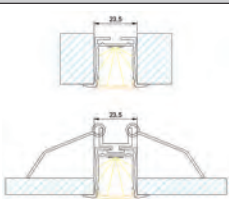

Color's-Sliver

dimension	installation diagram
	

**LLP-14/60**



Color's-Sliver/Matt Black/Black

dimension	installation diagram
	







**LED Lum**  
Lighting.Simplified

---

## LED STRIP LIGHTS

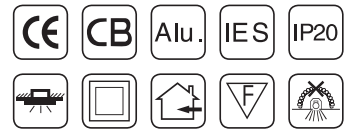

# LED STRIP LIGHTS

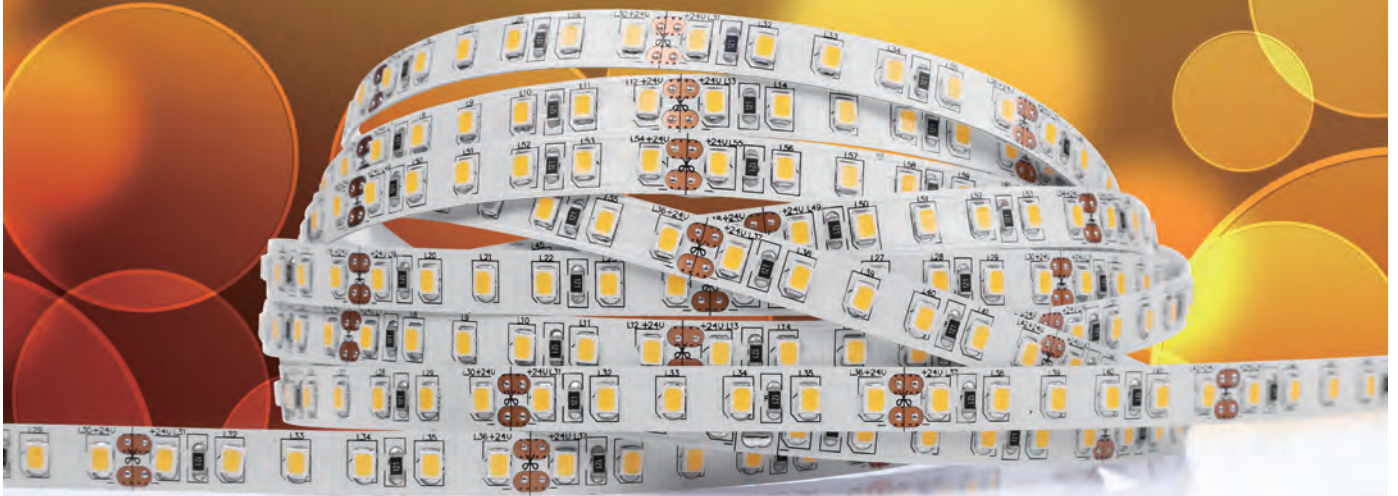

## INSTRUCTION

Input: AC220V-240V

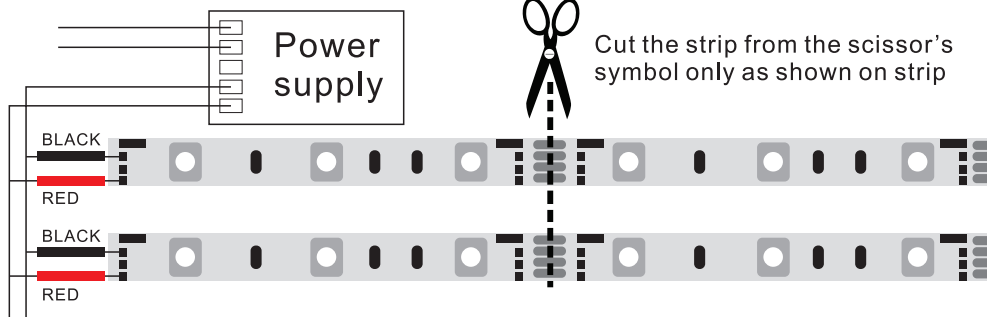





PRODUCT PARAMETERS



Model No.	Power	LED Chip	CRI	Lumens/Mtr	CCT	PCB Size	Lumens / LED	LED QTY/Mtr	Voltage
LSL001	4.8W	SANAN 2835 SMD	≥70	505Lm	3000K	8mm White	18-20	60	12V
LSL002	4.8W	SANAN 2835 SMD	≥70	505Lm	6000K	8mm White	18-20	60	12V
LSL003	4.8W	SANAN 2835 SMD	/	505Lm	BLUE	8mm White	/	60	12V
LSL004	4.8W	SANAN 2835 SMD	/	505Lm	RED	8mm White	/	60	12V
LSL005	4.8W	SANAN 2835 SMD	/	505Lm	GREEN	8mm White	/	60	12V
LSL006	4.8W	SANAN 2835 SMD	≥70	505Lm	4000K	8mm White	18-20	60	12V
LSL007	9W	SANAN 2835 SMD	≥70	961Lm	3000K	8mm White	18-20	120	12V
LSL008	9W	SANAN 2835 SMD	≥70	961Lm	6000K	8mm White	18-20	120	12V
LSL008A	9W	SANAN 2835 SMD	≥70	961Lm	4000K	8mm White	18-20	120	12V
LSL008B	17W	SANAN 2835 SMD	≥70	1800Lm	Warm White	10mm White	25-27	240	12V
LSL008C	17W	SANAN 2835 SMD	≥70	1800Lm	4000K	10mm White	25-27	240	12V
LSL008D	13W	SANAN 2835 SMD	≥70	1470Lm	3000K	10mm White	18-20	168	12V
LSL008E	13W	SANAN 2835 SMD	≥70	1470Lm	4000K	10mm White	18-20	168	12V
LSL066	5W	SANAN 2835 SMD	≥70	500Lm	3000K	10mm White	18-20	60	24V
LSL067	5W	SANAN 2835 SMD	≥70	500Lm	4000K	10mm White	18-20	60	24V
LSL068	10.5W	SANAN 2835 SMD	≥70	950Lm	3000K	10mm White	18-20	120	24V
LSL069	10.5W	SANAN 2835 SMD	≥70	950Lm	4000K	10mm White	18-20	120	24V
LSL070	17W	SANAN 2835 SMD	≥70	1800Lm	3000K	10mm White	25-27	240	24V
LSL071	17W	SANAN 2835 SMD	≥70	1800Lm	4000K	10mm White	25-27	240	24V



## INSTRUCTION

Input: AC220V-240V

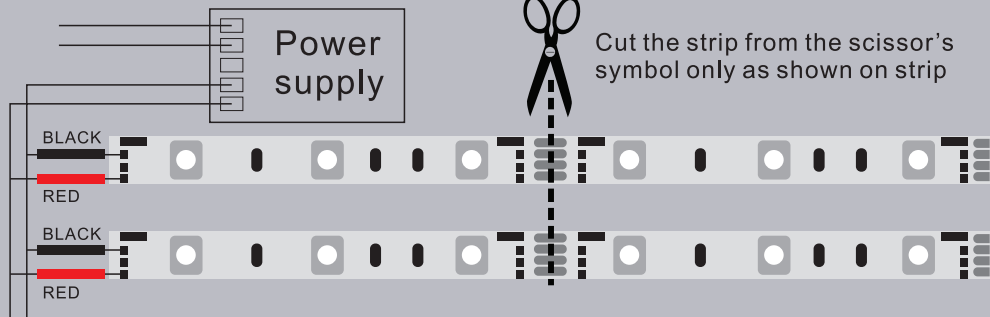



**PRODUCT PARAMETERS**



Model No.	Power	LED Chip	CRI	Lumens/Mtr	CCT	PCB Size	Lumens / LED	LED QTY/Mtr	Voltage
LSL009	12W	SANAN 5050 SMD	≥70	946Lm	3000K	10mm White	18-20	60	12V
LSL010	12W	SANAN 5050 SMD	≥70	946Lm	6000K	10mm White	18-20	60	12V
LSL011	12W	SANAN 5050 SMD	≥70	/	BLUE	10mm White	/	60	12V



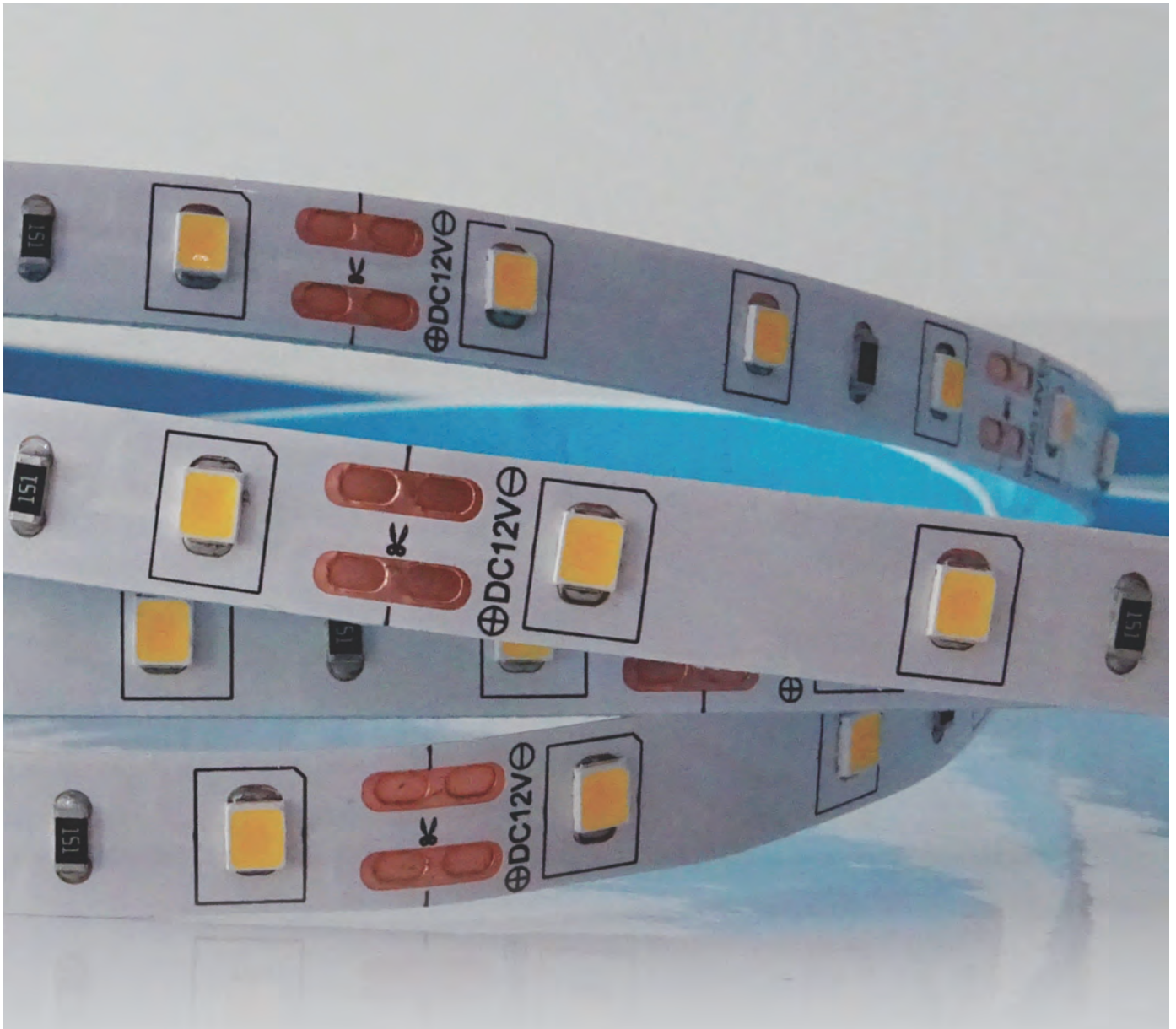

## INSTRUCTION

Input: AC220V-240V

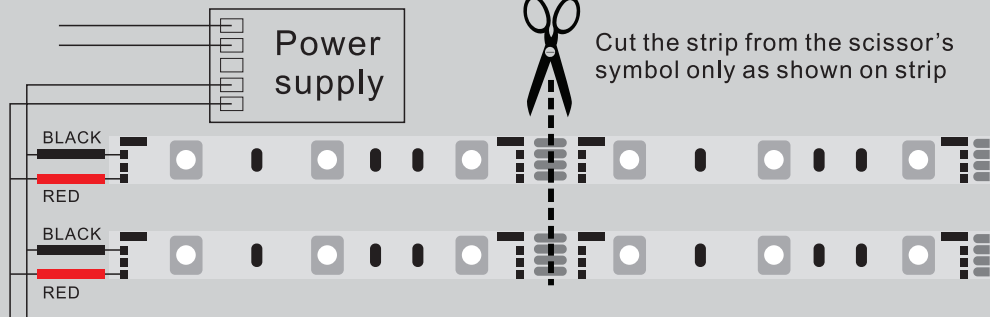



PRODUCT PARAMETERS



Model No.	Power	LED Chip	CRI	Lumens/Mtr	CCT	PCB Size	Lumens / LED	LED QTY/Mtr	Voltage
L+LSL001	5.4W	SANAN 2835 SMD	≥80	565Lm	3000K	8mm White	24-26	60	12V
L+LSL002	5.4W	SANAN 2835 SMD	≥80	565Lm	White	8mm White	24-26	60	12V
L+LSL003	5.4W	SANAN 2835 SMD	≥80	565Lm	4000K	8mm White	24-26	60	12V
L+LSL004	10W	SANAN 2835 SMD	≥80	1093Lm	3000K	8mm White	24-26	120	12V
L+LSL005	10W	SANAN 2835 SMD	≥80	1093Lm	4000K	8mm White	24-26	120	12V
L+LSL006	10W	SANAN 2835 SMD	≥80	1093Lm	White	8mm White	24-26	120	12V
L+LSL007	14W	SANAN 2835 SMD	≥80	1650Lm	3000K	10mm White	24-26	168	12V
L+LSL008	14W	SANAN 2835 SMD	≥80	1650Lm	4000K	10mm White	24-26	168	12V
L+LSL010	17.5W	SANAN 2835 SMD	≥80	2007Lm	4000K	10mm-2OZ White	24-26	240	12V

LED STRIP LIGHTS





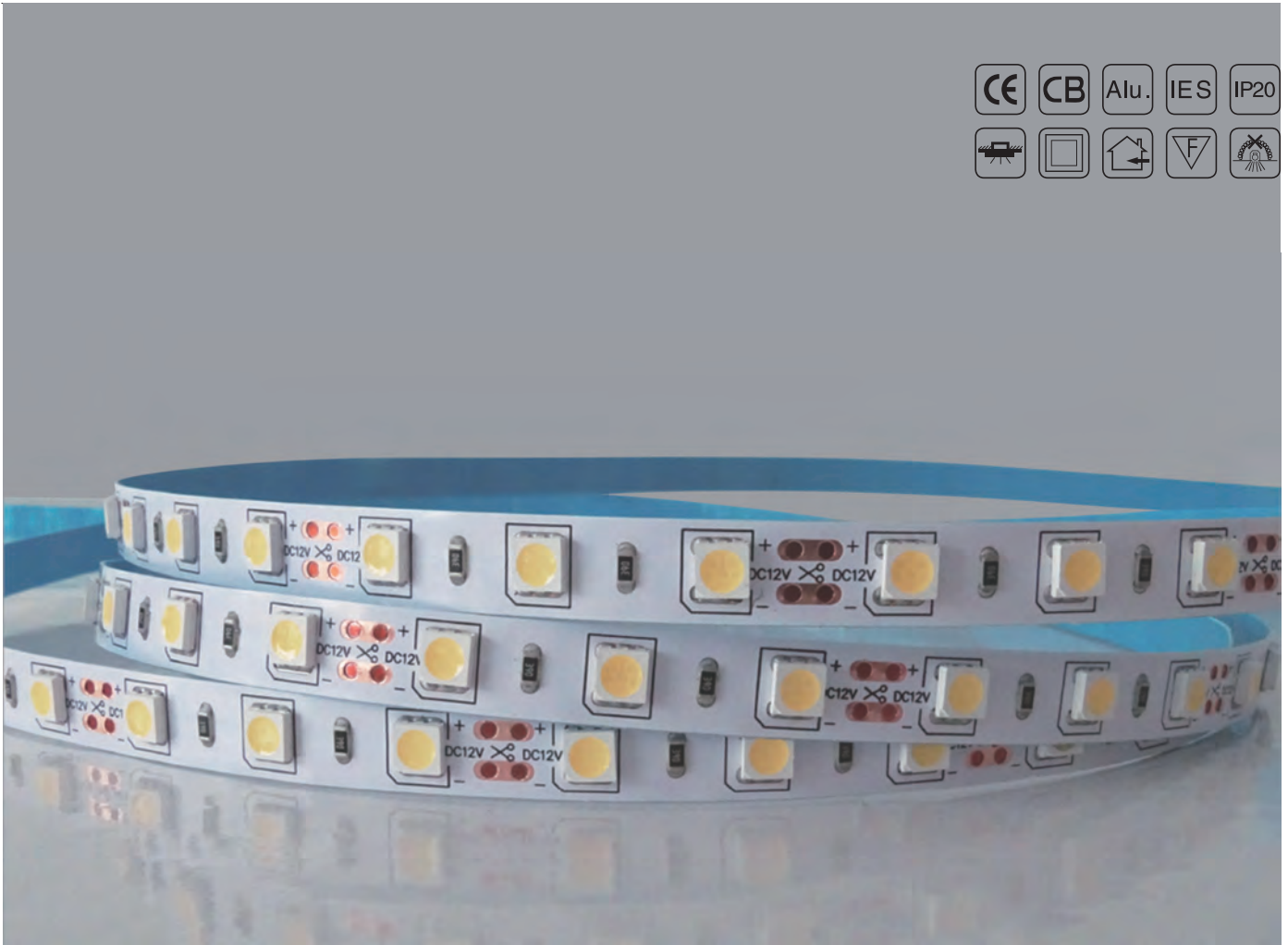

PRODUCT PARAMETERS



Model No.	Power	LED Chip	CRI	Lumens/Mtr	CCT	PCB Size	Lumens / LED	LED QTY/Mtr	Voltage
L+LSL011	13.5W	SANAN 5050 SMD	≥80	1213Lm	3000K	10mm White	20-22	60	12V
L+LSL012	13.5W	SANAN 5050 SMD	≥80	1213Lm	4000K	10mm White	20-22	60	12V
L+LSL013	13W	SANAN 5050 SMD	≥80	1248Lm	3000K	10mm-2OZ White	20-22	120	12V
L+LSL014	13W	SANAN 5050 SMD	≥80	1248Lm	4000K	10mm-2OZ White	20-22	120	12V

INSTRUCTION

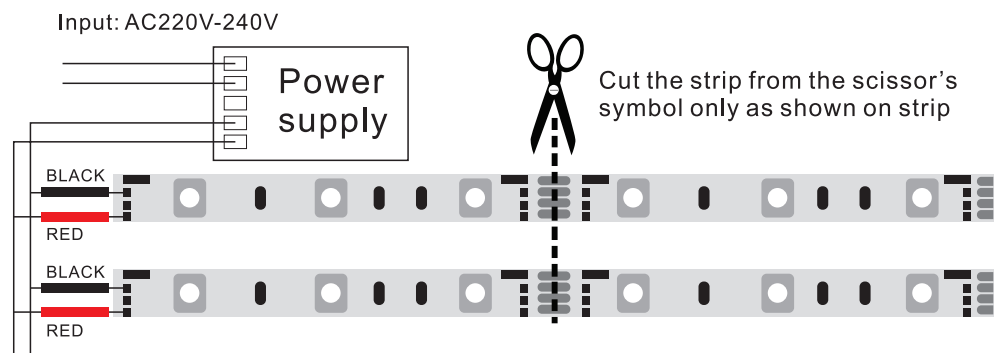

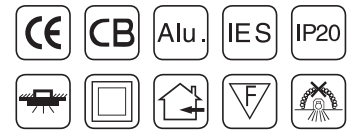

**PRODUCT PARAMETERS**



Model No.	Power	LED Chip	CRI	Lumens/Mtr	CCT	PCB Size	Lumens / LED	LED QTY/Mtr	Voltage
L+LSL015	10W	SANAN 2835 SMD	≥80	1093lm	3000k	5mm White	24-26	120	12V
L+LSL016	10W	SANAN 2835 SMD	≥80	1093lm	4000k	5mm White	24-26	120	12V

**INSTRUCTION**

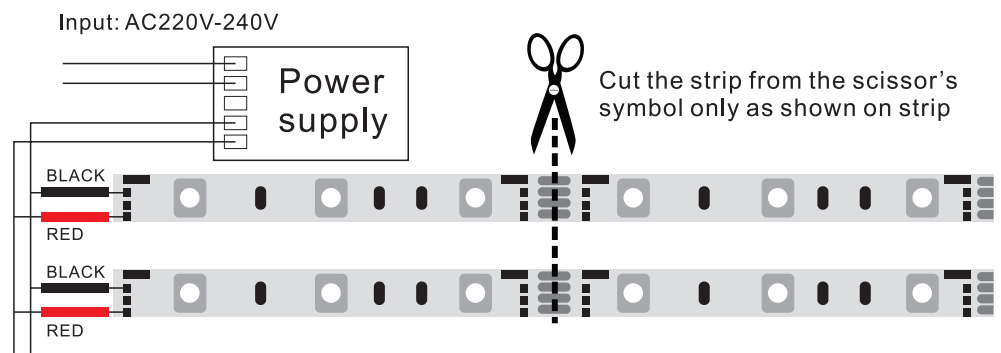

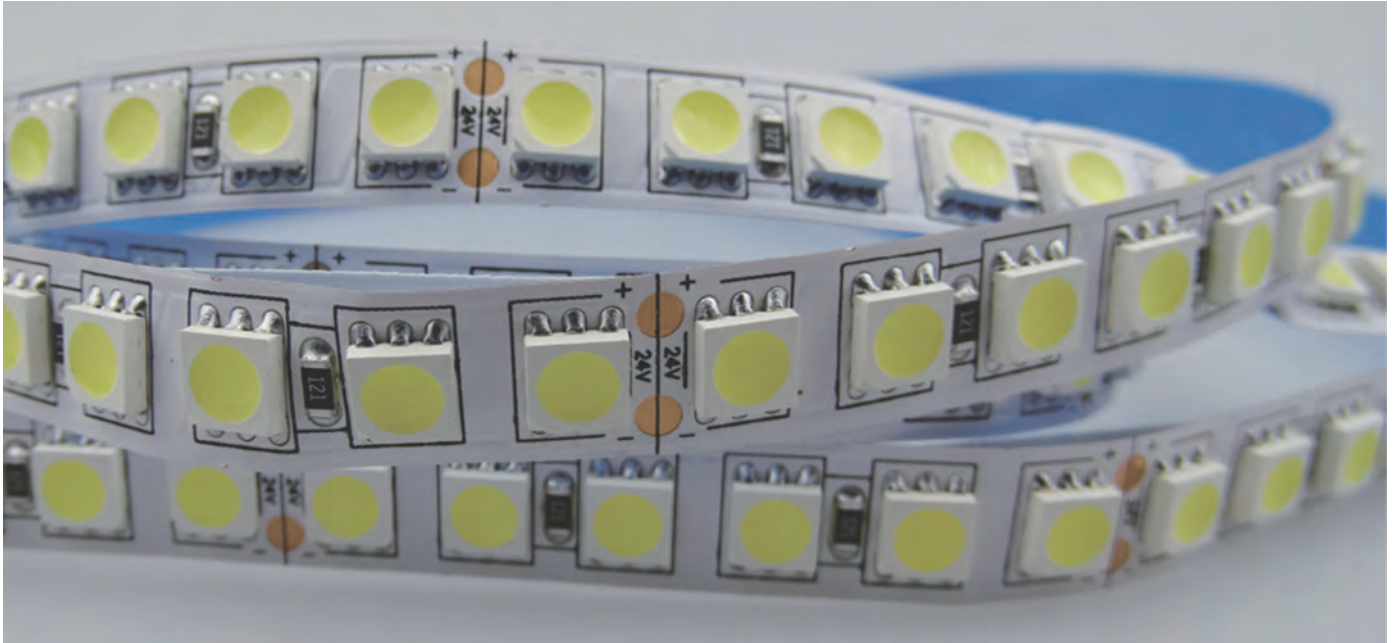
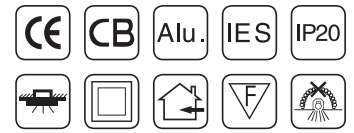

PRODUCT PARAMETERS



Model No.	Power	LED Chip	CRI	Lumens/Mtr	CCT	PCB Size	Lumens / LED	LED QTY/Mtr	Voltage
L+LSL017	13W	SANAN 5050 SMD	≥80	1280Lm	3000k	10mm-2OZ White	20-22	120	24V
L+LSL018	13W	SANAN 5050 SMD	≥80	1280Lm	4000k	10mm-2OZ White	20-22	120	24V
L+LSL019	17W	SANAN 5050 SMD	≥80	1650Lm	3000k	15mm-2OZ White	20-22	120	24V
L+LSL020	17W	SANAN 5050 SMD	≥80	1650Lm	4000k	15mm-2OZ White	20-22	120	24V
L+LSL021	17.5W	SANAN 2835 SMD	≥70	2057Lm	3000k	10mm-2OZ White	24-26	240	24V
L+LSL022	17.5W	SANAN 2835 SMD	≥70	2057Lm	4000k	10mm-2OZ White	24-26	240	24V

INSTRUCTION

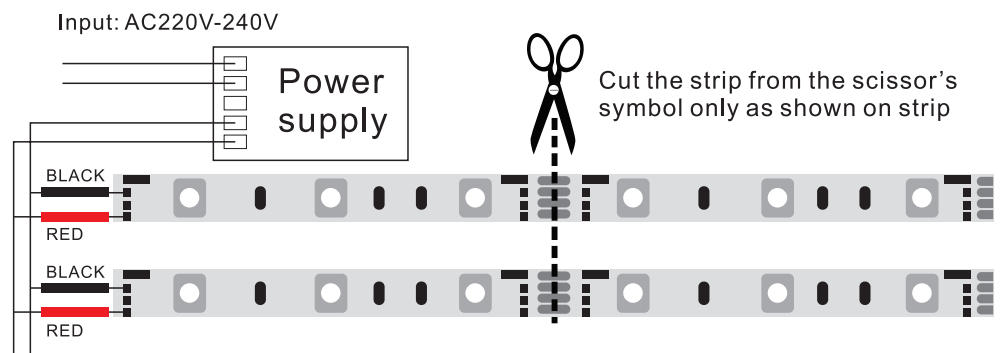

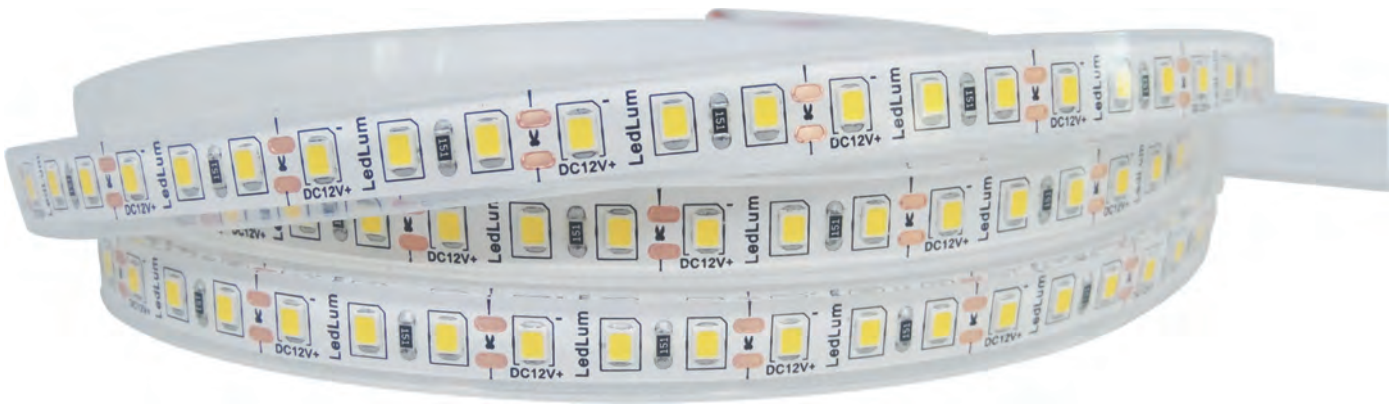
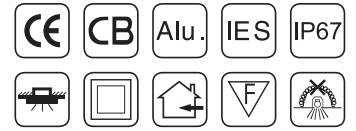

IP67

**PRODUCT PARAMETERS**



Model No.	Power	LED Chip	CRI	Lumens/Mtr	CCT	PCB Size	Lumens / LED	LED QTY/Mtr	Voltage
L+LSL023	9,5W	SANAN 2835 SMD	≥80	1051lm	3000K	8mm White	24-26	120	12V
L+LSL024	10W	SANAN 5050 SMD	≥80	1113lm	3000K	10mm White	20-22	60	12V

**INSTRUCTION**

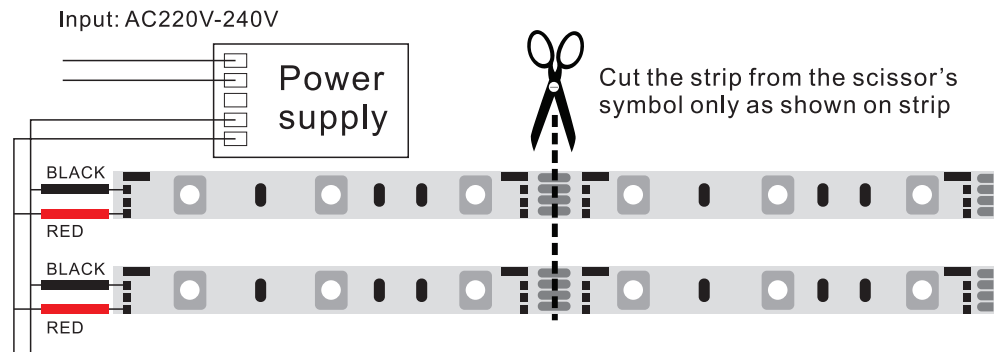



DIMMABLE/TUNABLE

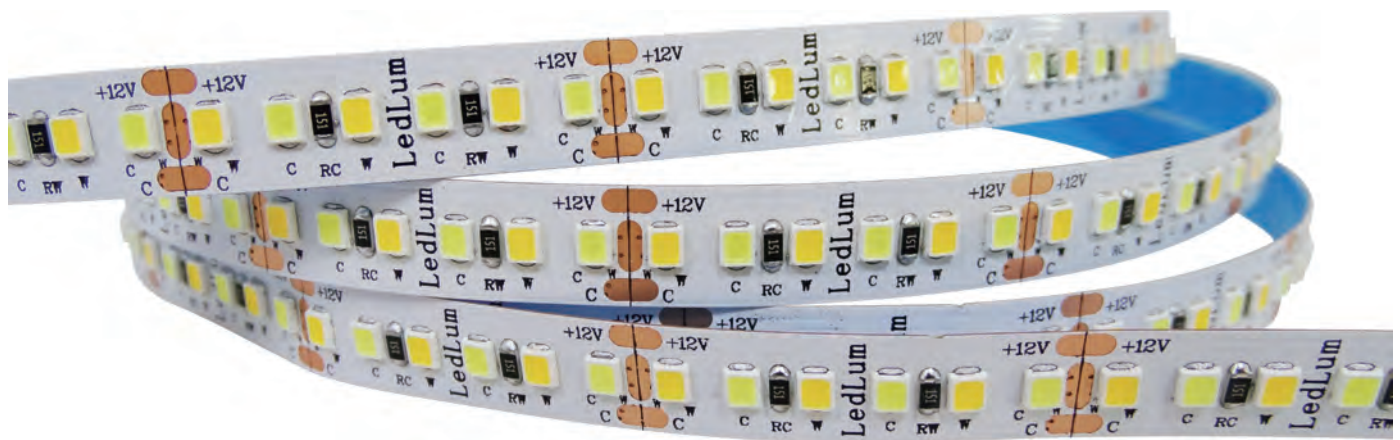
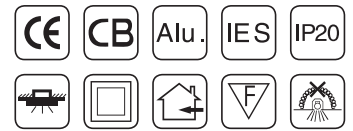

PRODUCT PARAMETERS



Model No.	Power	LED Chip	CRI	Lumens/Mtr	CCT	PCB Size	Lumens / LED	LED QTY/Mtr	Voltage
L+LSL025	14W	SANAN 2835 SMD	≥80	1647Lm	White+Warm White	10mm White	24-26	180	12V

\*Dimmable/Tunable

ACCESSORIES



SINGLE 20MM ROLL CUTTABLE  
NO POWER LOSS

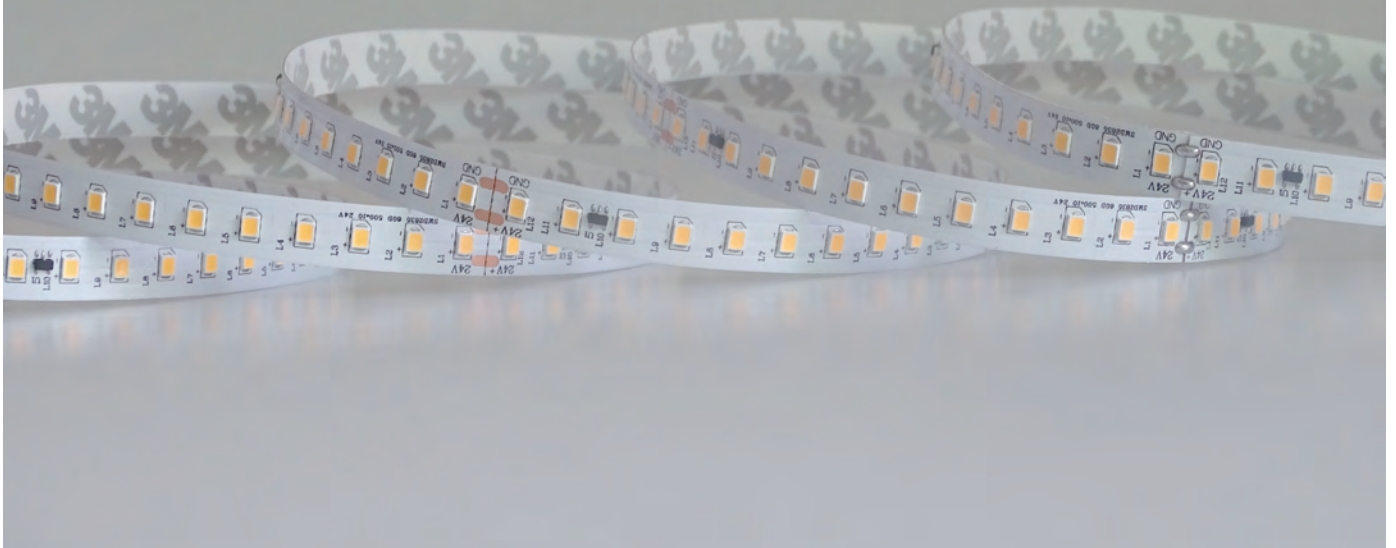

**PRODUCT PARAMETERS**



Model No.	Power	LED Chip	CRI	Lumens/Mtr	CCT	PCB Size	Lumens / LED	LED QTY/Mtr	Voltage
L+LSL026	9.2W	2835 SANAN SMD LED	≥80	1032Lm	3000K	10mm White	24-26	120	24
L+LSL027	9.2W	2835 SANAN SMD LED	≥80	1032Lm	4000K	10mm White	24-26	120	24
L+LSL028	9.2W	2835 SANAN SMD LED	≥80	1032Lm	6000K	10mm White	24-26	120	24

**INSTRUCTION**

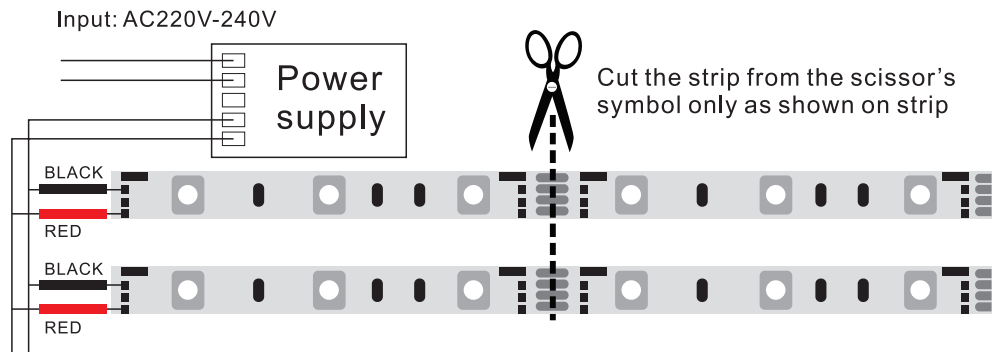



LED STRIP LIGHT  
REMOTE CONTROLLER AND AMPLIFIER AVAILABLE

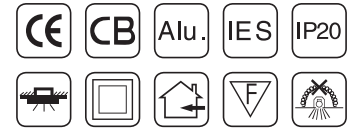

PRODUCT PARAMETERS



Model No.	Power	LED Chip	CRI	Lumens/Mtr	CCT	PCB Size	Beam Angle	LED Qty/Mtr	Voltage
L+LSL029	15W	SANAN	≥80	800Lm	RGB/IC	12mm White	120°	/	24V
L+LSL030	12W	SANAN	≥80	1477Lm	TUNABLE / DIMMABLE 3000K+6000K	8mm White	120°	/	24V
LSL072	13W	SANAN	≥80	1300Lm	3000K	8mm White	120°	/	24V
LSL073	13W	SANAN	≥80	1300Lm	4000K	8mm White	120°	/	24V





**PRODUCT PARAMETERS**



Model No.	Power	LED Chip	CRI	Lumens/Mtr	CCT	PCB Size	Lumens / LED	LED QTY/Mtr	Voltage
LSL043	5.3W	2835 SANAN SMD LED	≥70	258Lm	3000K	6mm White	2835 SANAN	60	220V
LSL044	5.3W	2835 SANAN SMD LED	≥80	258Lm	White	6mm White	2835 SANAN	60	220V
LSL045	5.3W	2835 SANAN SMD LED	≥70	258Lm	Blue	6mm White	2835 SANAN	60	220V
LSL046	5.3W	2835 SANAN SMD LED	≥70	258Lm	Red	6mm White	2835 SANAN	60	220V
LSL047	5.3W	2835 SANAN SMD LED	≥70	258Lm	Green	6mm White	2835 SANAN	60	220V
LSL048	5.3W	2835 SANAN SMD LED	≥70	258Lm	2200K	6mm White	2835 SANAN	60	220V

**INSTRUCTION**

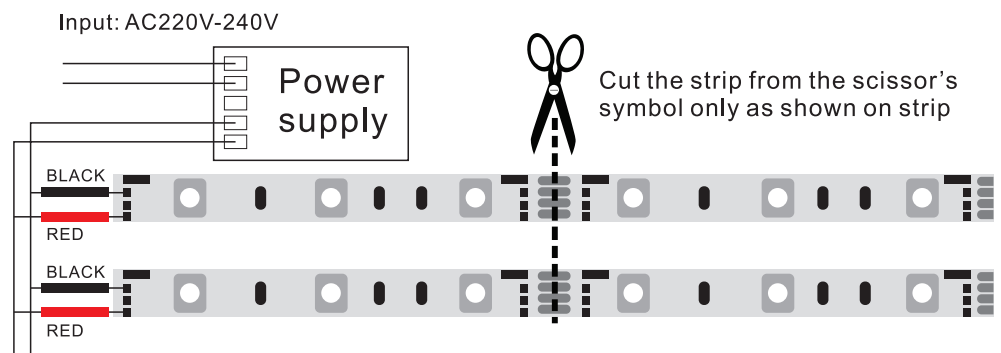

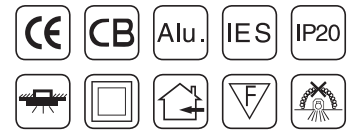

PRODUCT PARAMETERS



Model No.	Power	LED Chip	CRI	Lumens/Mtr	CCT	PCB Size	Lumens / LED	LED QTY/Mtr	Voltage
LSL043A	7.3W	2835 SANAN SMD LED	≥70	619Lm	3000K	8mm White	18-20	120	220V

INSTRUCTION

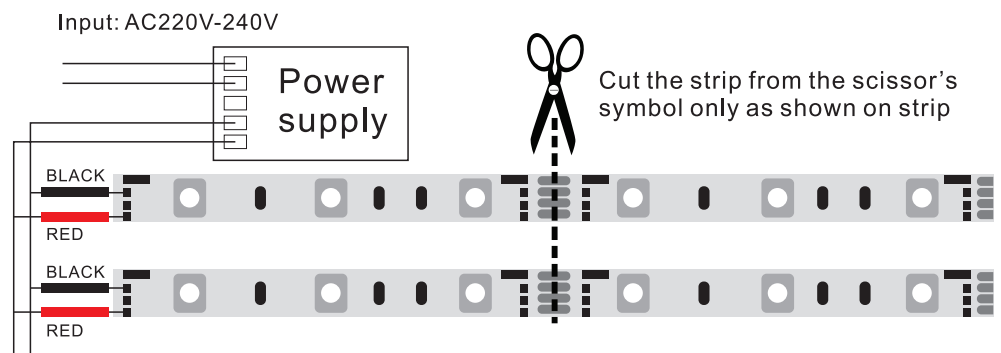



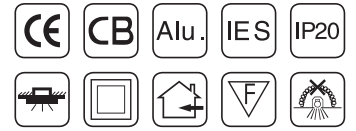

**PRODUCT PARAMETERS**



Model No.	Power	LED Chip	CRI	Lumens/Mtr	CCT	PCB Size	Lumens / LED	LED QTY/Mtr	Voltage
LSL049A	8.5W	5050 SANAN SMD LED	≥80	612Lm	3000K	12mm White	20-22	120	220V

**INSTRUCTION**

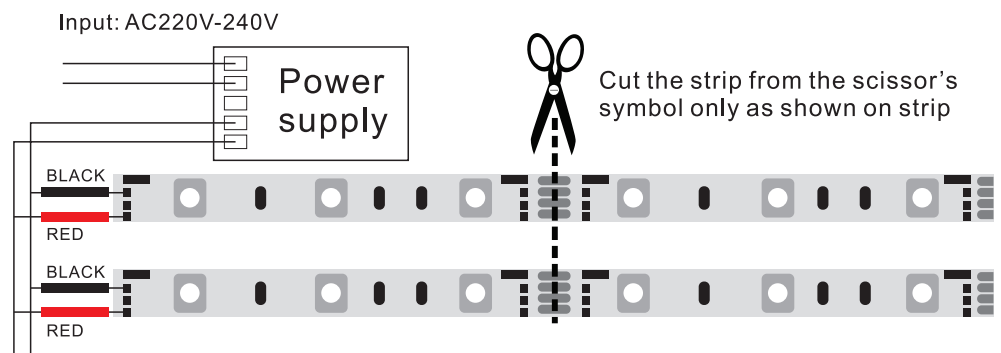

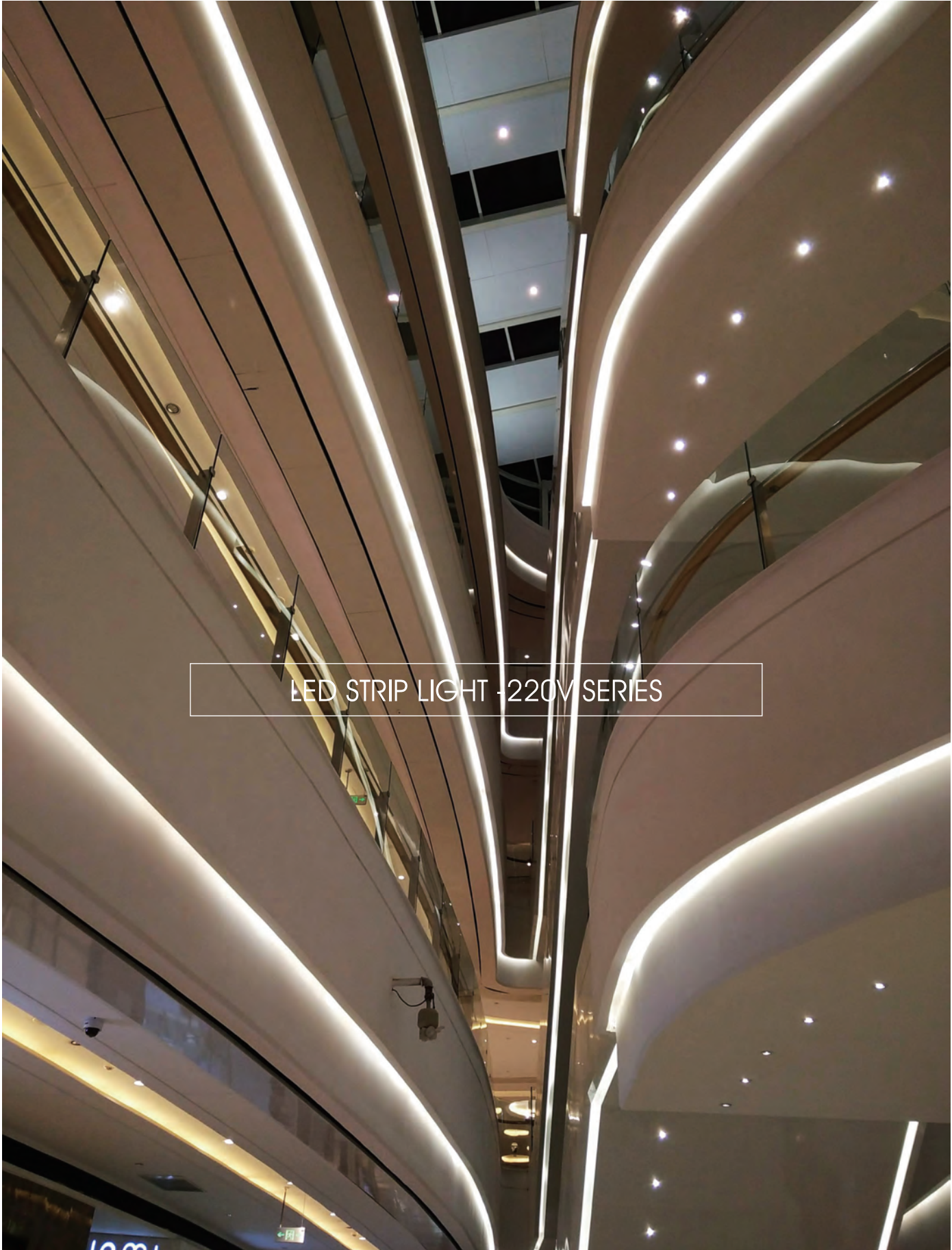

LED STRIP LIGHT - 220V SERIES





**PRODUCT PARAMETERS**

Model No.	Power	LED Chip	CRI	Lumens/Mtr	CCT	PCB Size	Lumens / LED	LED QTY/Mtr	Voltage
LSL049	6.8W	5050 SANAN SMD LED	≥70	450Lm	3000K	8mm	18-20	60	220V
LSL050	6.8W	5050 SANAN SMD LED	≥70	450Lm	6000K	8mm	18-20	60	220V
LSL051	6.8W	5050 SANAN SMD LED	≥70	450Lm	Blue	8mm	18-20	60	220V
LSL052	6.8W	5050 SANAN SMD LED	≥70	450Lm	RED	8mm	18-20	60	220V
LSL053	6.8W	5050 SANAN SMD LED	≥70	450Lm	GREEN	8mm	18-20	60	220V
LSL054	6.8W	5050 SANAN SMD LED	≥70	450Lm	2200K	8mm	18-20	60	220V

**INSTRUCTION**

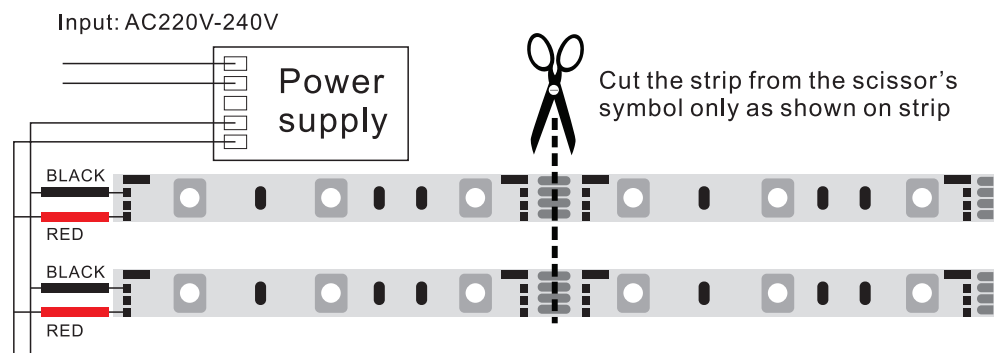



LED STRIP LIGHT -220V SERIES

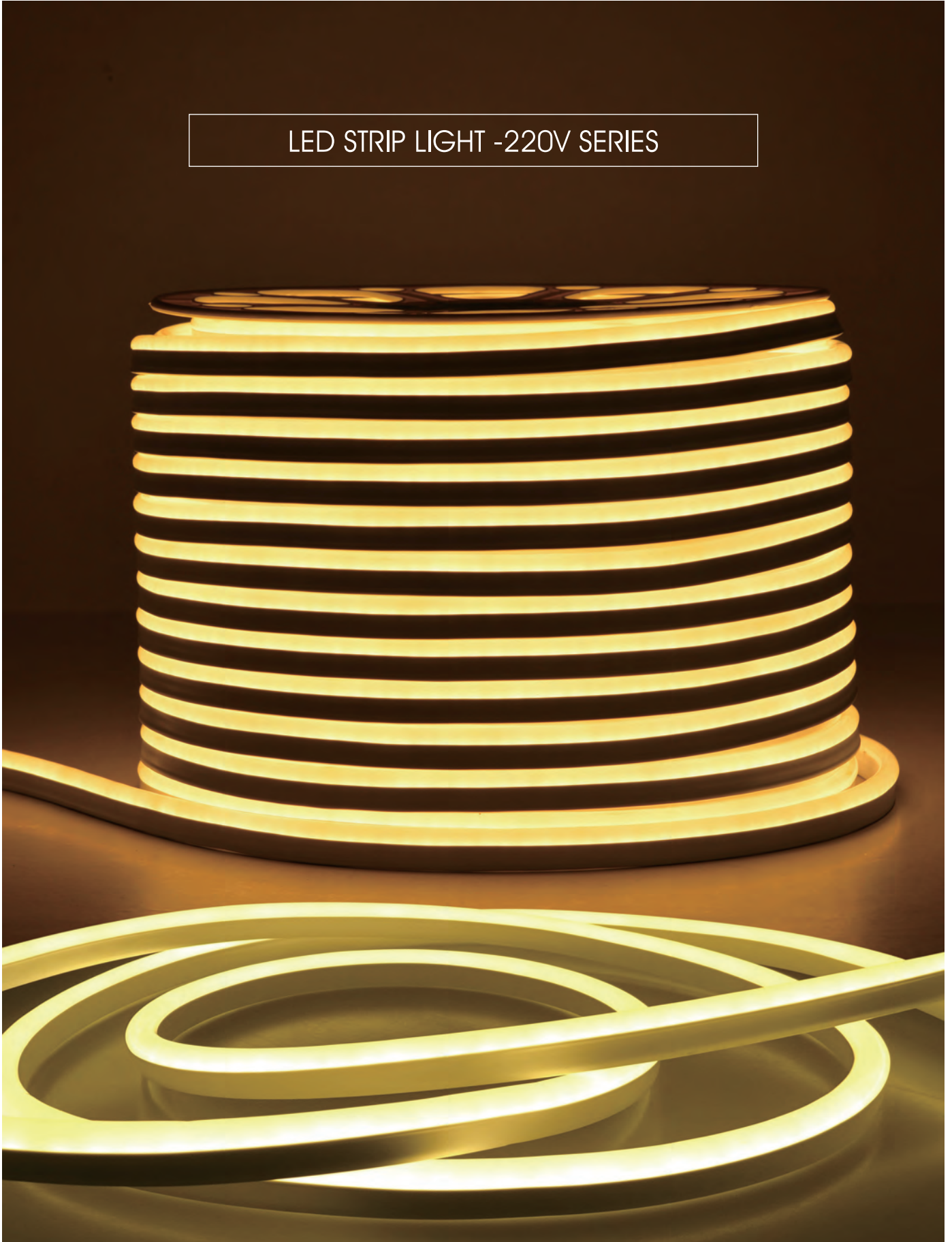

25 MT ROLL NO POWER LOSS



**PRODUCT PARAMETERS**



Model No.	Power	LED Chip	CRI	Lumens/Mtr	CCT	PCB Size	Lumens / LED	LED QTY/Mtr	Voltage
LSL055	7.5W	SANAN SMD	≥80	291Lm	3000K	6mm White	2835 SANAN	120	220V
LSL056	7.5W	SANAN SMD	≥80	291Lm	6000K	6mm White	2835 SANAN	120	220V
LSL057	7.5W	SANAN SMD	≥80	291Lm	Blue	6mm White	2835 SANAN	120	220V
LSL058	7.5W	SANAN SMD	≥80	291Lm	Red	6mm White	2835 SANAN	120	220V
LSL059	7.5W	SANAN SMD	≥80	291Lm	Green	6mm White	2835 SANAN	120	220V
LSL060	7.5W	SANAN SMD	≥80	291Lm	Yellow	6mm White	2835 SANAN	120	220V

**INSTRUCTION**

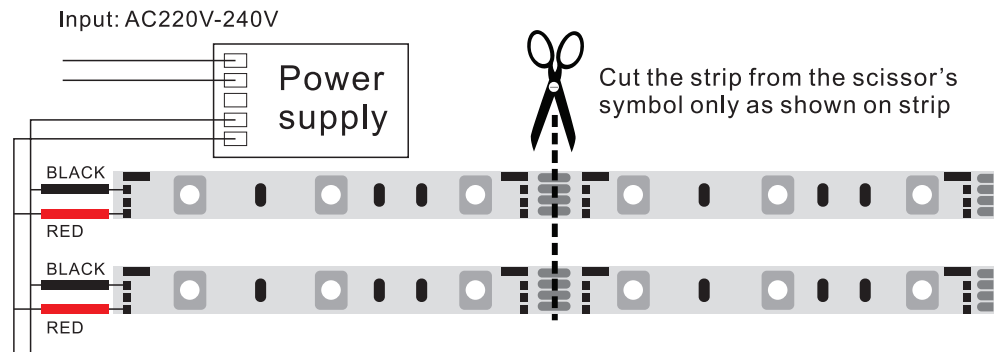



PRODUCT PARAMETERS



Model No.	Power	LED Chip	CRI	Lumens/Mtr	CCT	PCB Size	Lumens / LED	LED QTY/Mtr	Voltage
LSL062	7.1W	SANAN SMD	≥80	509Lm	3000K	8mm White	20-22	60	220V

INSTRUCTION

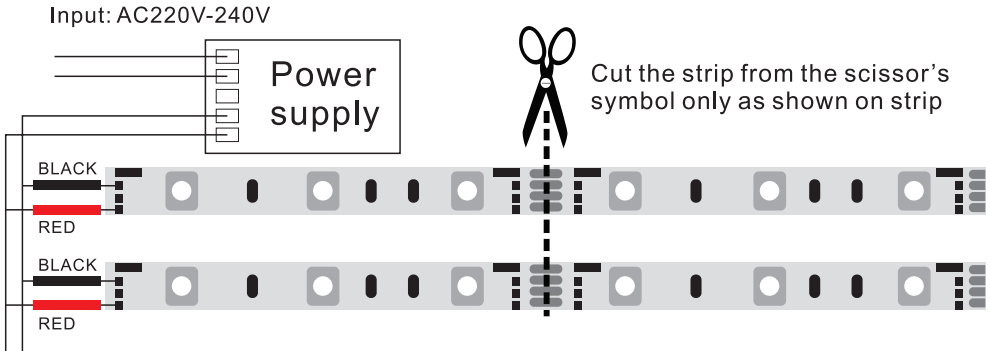



25 MT ROLL NO POWER LOSS

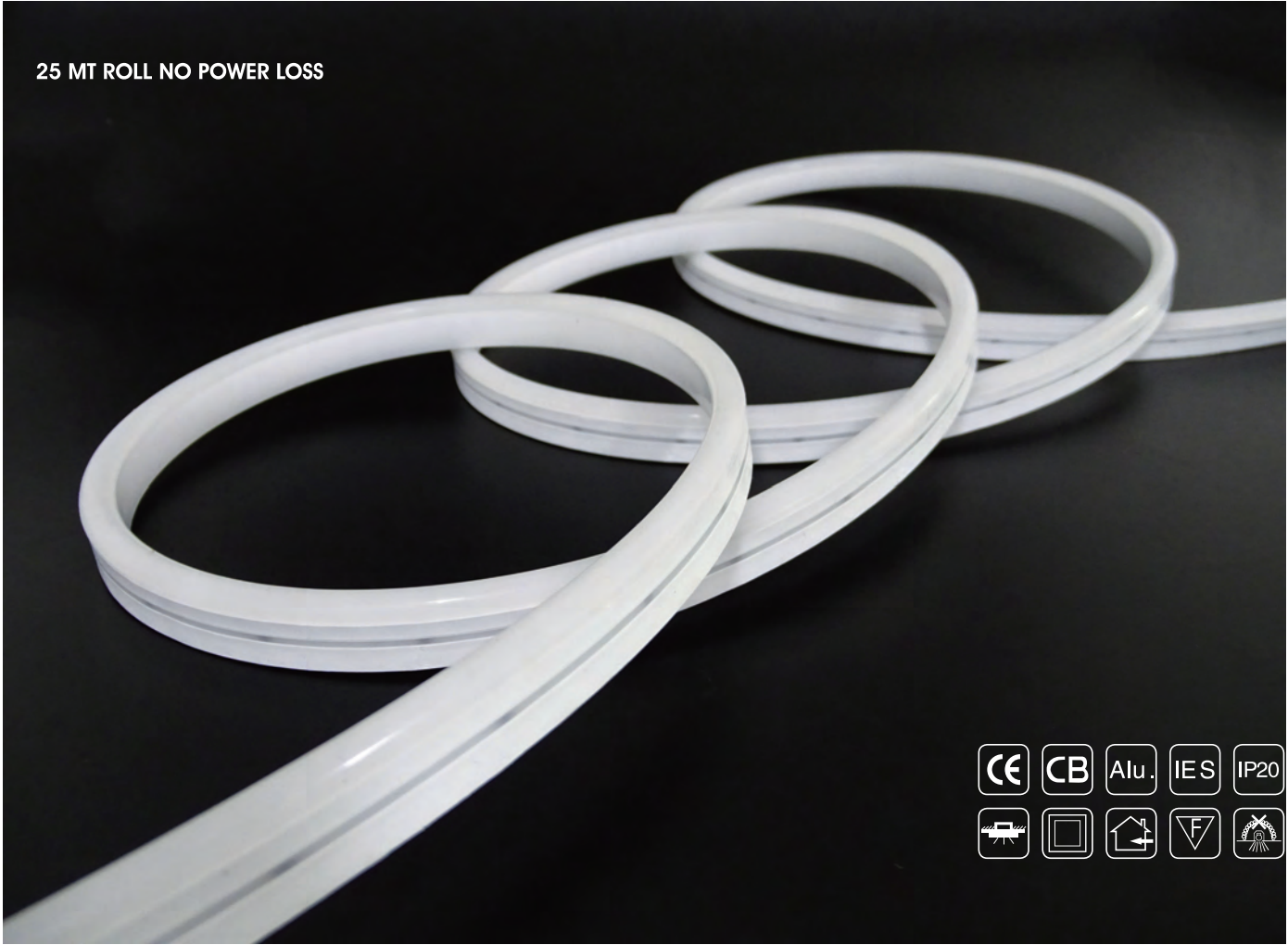

**PRODUCT PARAMETERS**



Model No.	Power	LED Chip	CRI	Lumens/Mtr	CCT	PCB Size	Lumens / LED	LED QTY/Mtr	Voltage
LSL063	10W	SANAN 2835 SMD	≥80	350Lm	3000K	8mm White	24-26	120	24V
LSL064	10W	SANAN 2835 SMD	≥80	350Lm	4000K	8mm White	24-26	120	24V
LSL065	10W	SANAN 2835 SMD	≥80	350Lm	Blue	8mm White	24-26	120	24V

**INSTRUCTION**

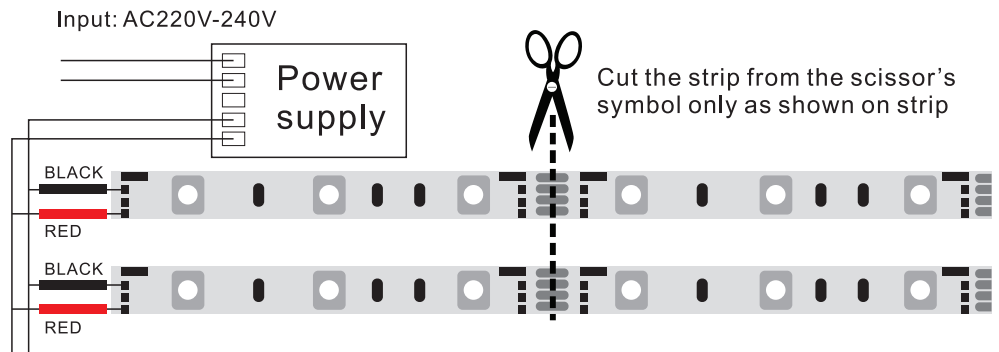

## NEON ROPE LIGHTS

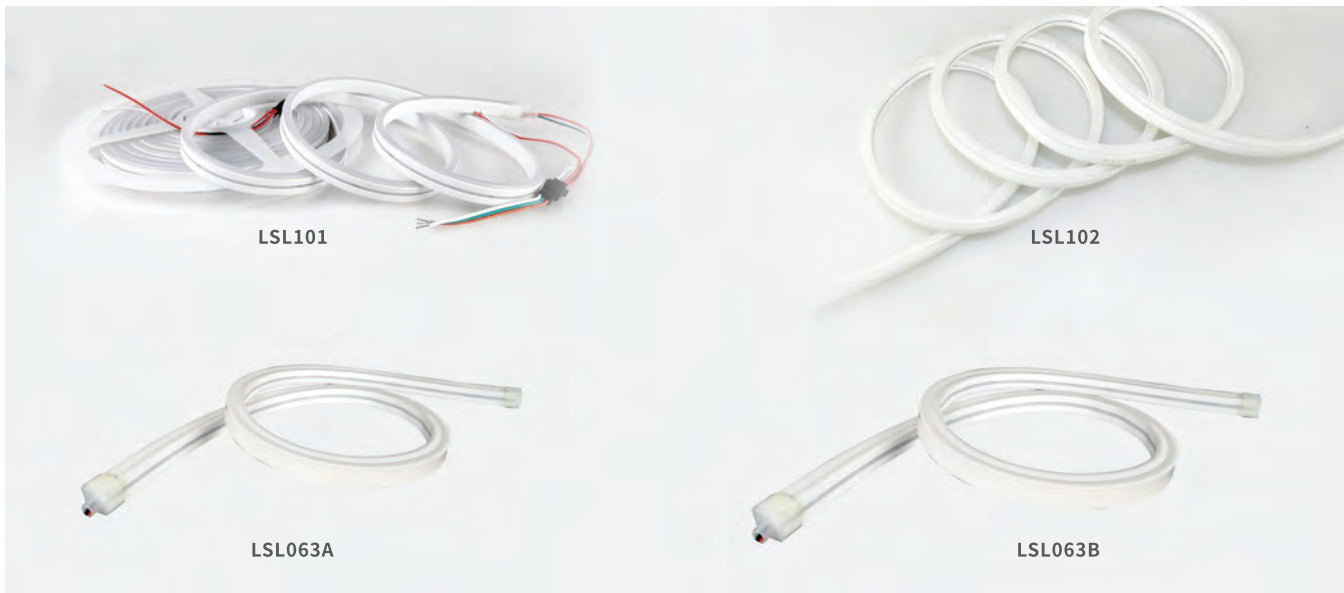
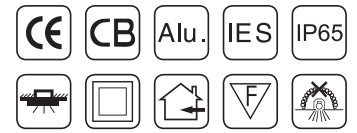

### PRODUCT PARAMETERS



Model No.	Power	Material	LED Chip	CRI	Lumens/Mtr	CCT	PCB Size	Beam Angle	IP	LED Qty/Mtr	Voltage
LSL101	16W	Copy Silicon	SANAN	/	/	RGB/IC	6*12mm White	120°	IP 65	/	24V
LSL102	16W	Copy Silicon	SANAN	/	/	RGB/IC	8*16mm White	120°	IP 65	/	24V
LSL063A	9W	Silicon	SANAN	≥80	600Lm	3000K	16*16mm White	120°	IP 65	/	24V
LSL063B	9W	Silicon	SANAN	≥80	600Lm	3000K	12*12mm White	120°	IP 65	/	24V







# LED Lum

Lighting. Simplified

LED STRIP LIGHT DRIVER



LD001



LD002



LD003



LD004



LD005



LD006



LD007



LD008



LD009

**PRODUCT PARAMETERS**

Model No.	Power	Dimension	Current	Voltage	IP
LD001	15W	70*38*30mm	1AMP	12V	IP20
LD002	25W	85*58*33mm	2AMP	12V	IP20
LD003	36W	85*58*33mm	3AMP	12V	IP20
LD004	50W	160*40*30mm	4AMP	12V	IP20
LD005	60W	160*40*30mm	5AMP	12V	IP20
LD006	120W	185*45*35mm	10AMP	12V	IP20
LD007	180W	220*65*40mm	15AMP	12V	IP20
LD008	240W	220*65*40mm	20AMP	12V	IP20
LD009	360W	220*65*40mm	30AMP	12V	IP20

**PRODUCT DIMENSION**

Unit (mm)

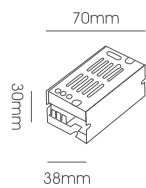

LD001-15W

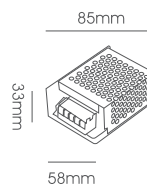

LD002-25W

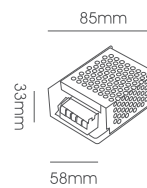

LD003-36W

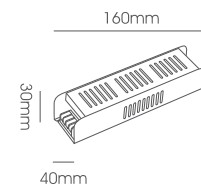

LD004-50W

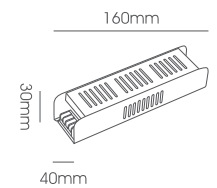

LD005-60W

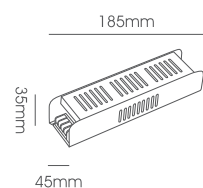

LD006-120W

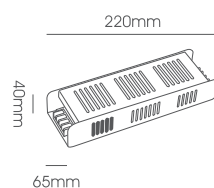

LD007-180W

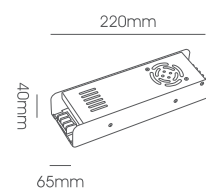

LD008-240W

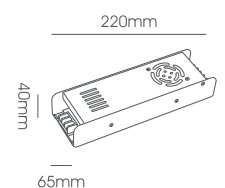

LD009-360W



**LD002A**



**LD003A**



**LD005A**



**LD006A**



**LD008A**

**PRODUCT PARAMETERS**

Model No.	Power	Dimension	Current	Voltage	IP
LD002A	25W	100*30*20mm	2AMP	12V	IP20
LD003A	36W	100*30*20mm	3AMP	12V	IP20
LD005A	60W	170*52*20mm	5AMP	12V	IP20
LD006A	120W	225*52*20mm	10AMP	12V	IP20
LD008A	240W	305*52*22mm	20AMP	12V	IP20

**PRODUCT DIMENSION**

Unit (mm)

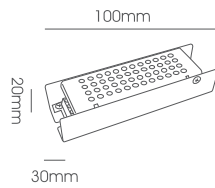

**LD002A-25W**

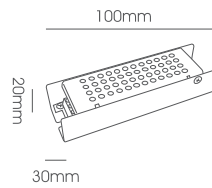

**LD003A-36W**

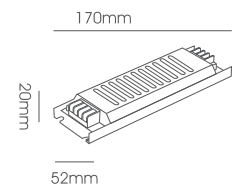

**LD005A-60W**

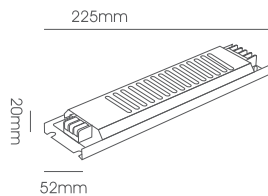

**LD006A-120W**

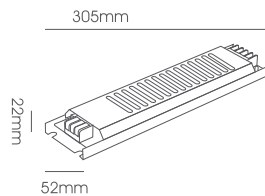

**LD008A-240W**

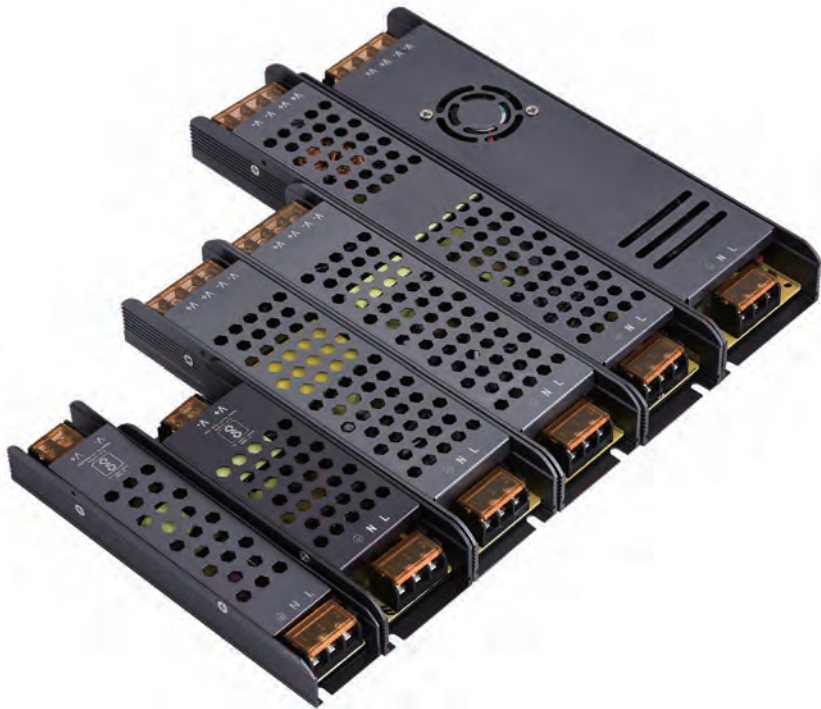

**PRODUCT PARAMETERS**

Model No.	Power	Dimension	Current	Voltage	IP
LD002AA	25W	135*34*23mm	2A	12V	IP20
LD003AA	36W	135*34*23mm	3A	12V	IP20
LD005AA	60W	170*34*23mm	5A	12V	IP20
LD006AA	120W	195*46*29mm	10A	24V	IP20
LD007AA	180W	195*46*29mm	15A	24V	IP20
LD008AA	240W	255*46*29mm	20A	24V	IP20
LD009AA	360W	245*62*29mm	30A	24V	IP20

**PRODUCT DIMENSION**

Unit (mm)

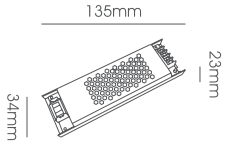

LD002AA-25W

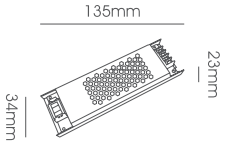

LD003AA-36W

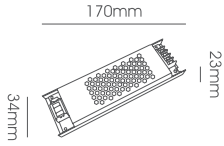

LD005AA-60W

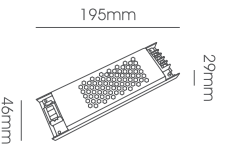

LD006AA-120W

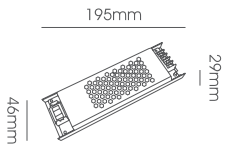

LD007AA-180W

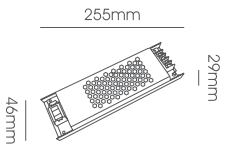

LD008AA-240W

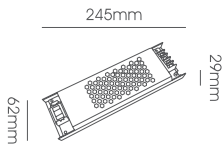

LD009AA-360W

**DIMMABLE**

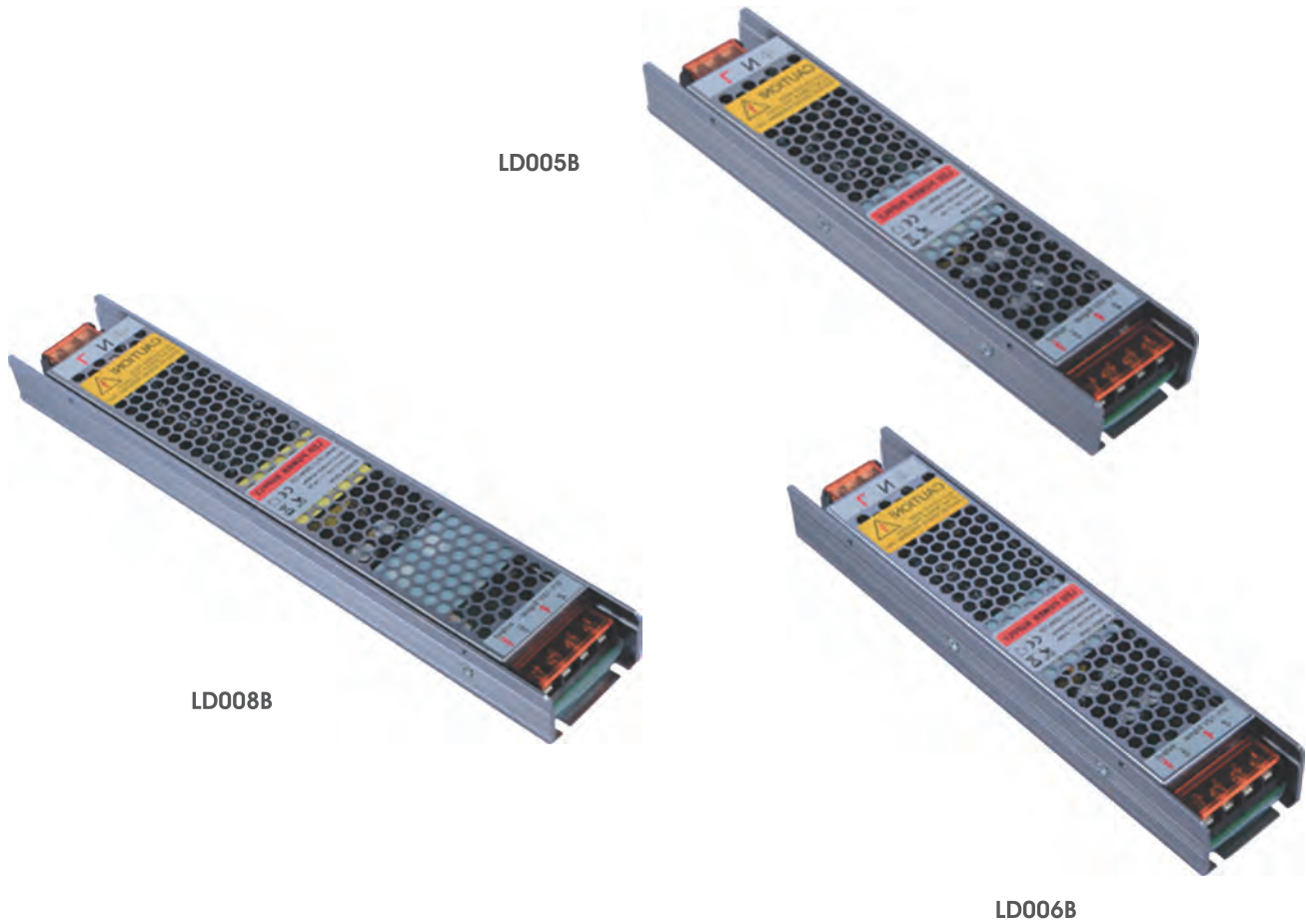

**PRODUCT PARAMETERS**

Model No.	Power	Dimension	Current	Voltage	IP
LD-005B	60W	170*50*30mm	5AMP	12V	IP20
LD-006B	100W	230*50*30mm	10AMP	12V	IP20
LD-008B	240W	288*50*30mm	20AMP	12V	IP20

**PRODUCT DIMENSION**

Unit (mm)

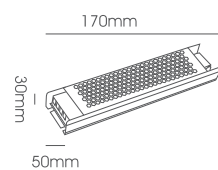

LD005B-60W

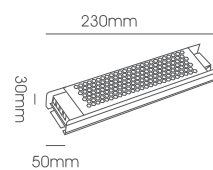

LD006B-100W

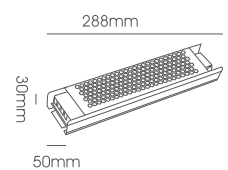

LD008B-240W





LD010



LD011



LD019



LD020

**PRODUCT PARAMETERS**

Model No.	Power	Dimension	Current	Voltage	IP
LD-010	15W	100*30*20mm	0,4AMP	24V	IP68
LD-011	20W	140*30*20mm	0,83AMP	24V	IP68
LD-019	60W	210*52*19mm	2,5A	24V	IP68
LD-020	120W	210*52*19mm	5A	24V	IP68

**PRODUCT DIMENSION**

Unit (mm)

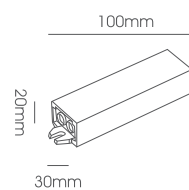

LD010-15W

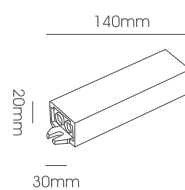

LD011-20W

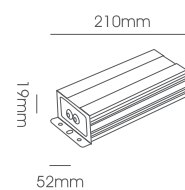

LD019-60W

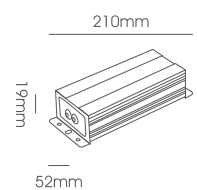

LD020-120W



### PRODUCT PARAMETERS

Model No.	Power	Dimension	Current	Voltage	IP
LD028	120W	138*50*23mm	5A	12V	IP20
LD029	240W	205*50*23mm	10A	12V	IP20
LD030	300W	205*50*23mm	12.5A	12V	IP20
LD031	24W	135*34*23mm	1A	12V	IP20
LD032	60W	88*50*20mm	2.5A	12V	IP20
LD033	180W	178*50*23mm	7.5A	12V	IP20

### PRODUCT DIMENSION

Unit (mm)

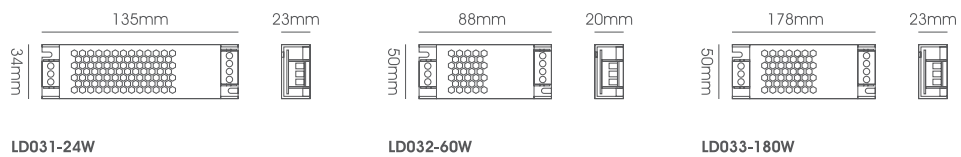
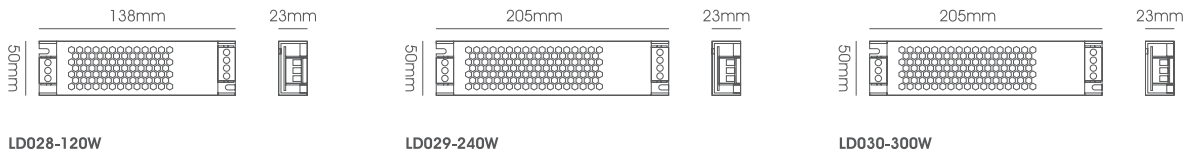



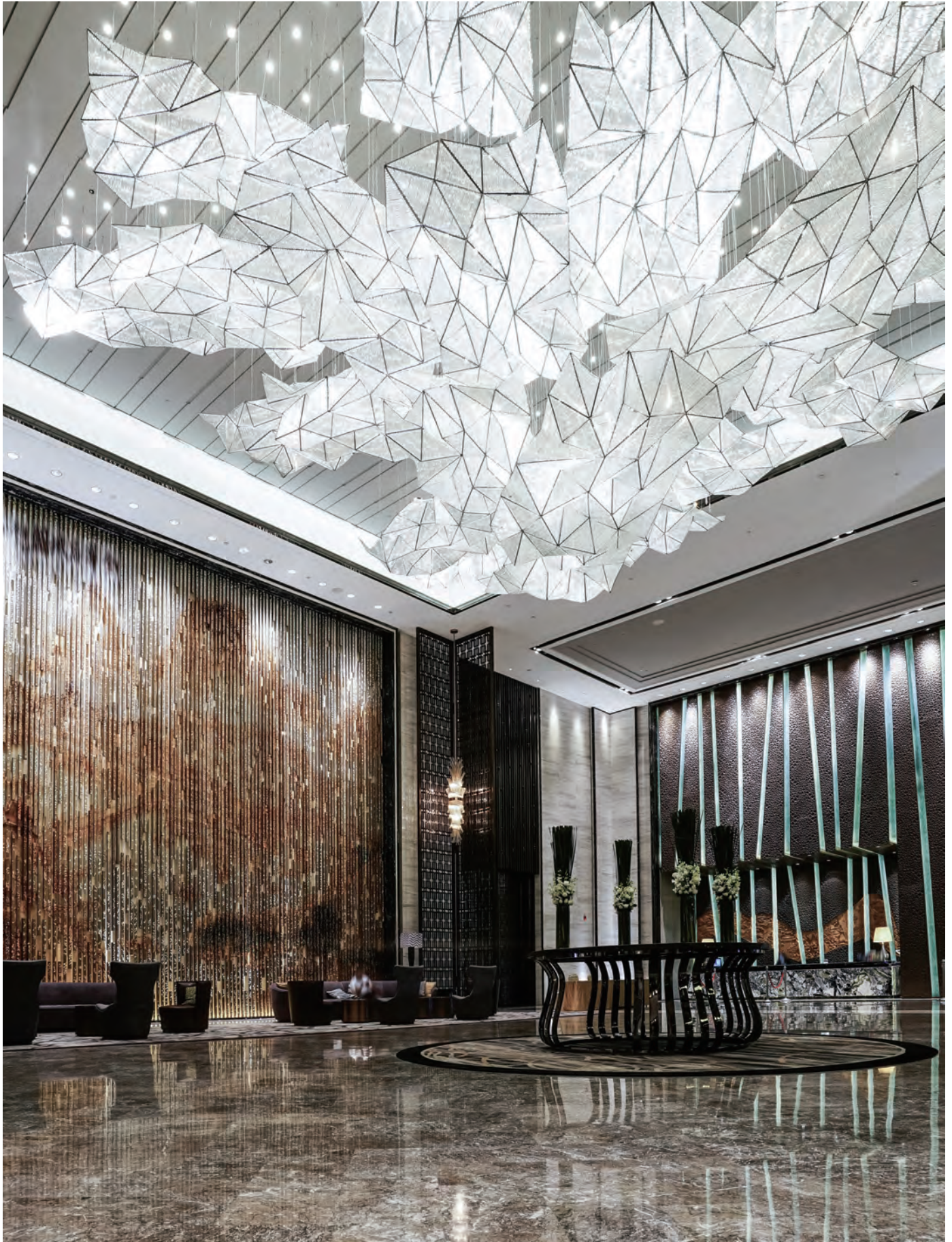



# LED LIGHTING LEDLUM-LUXE SERIES

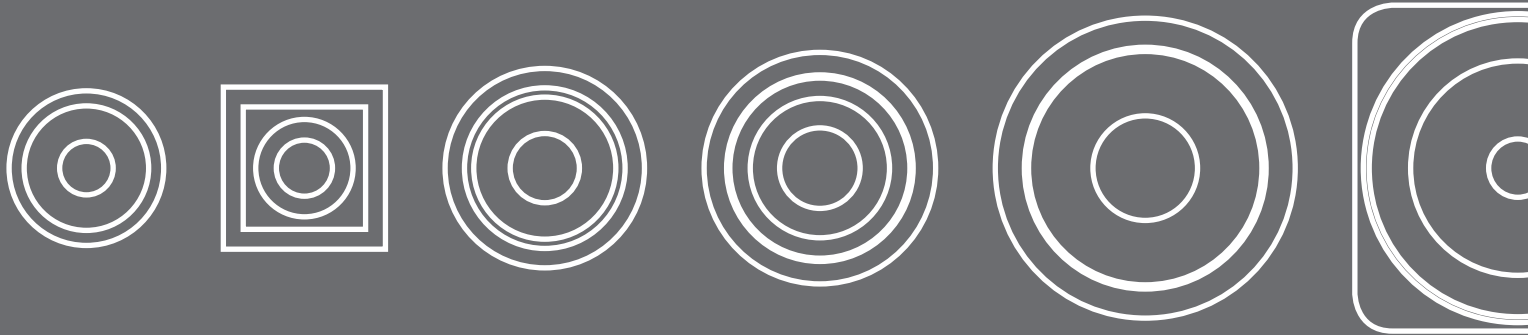

Lighting.

# Lum

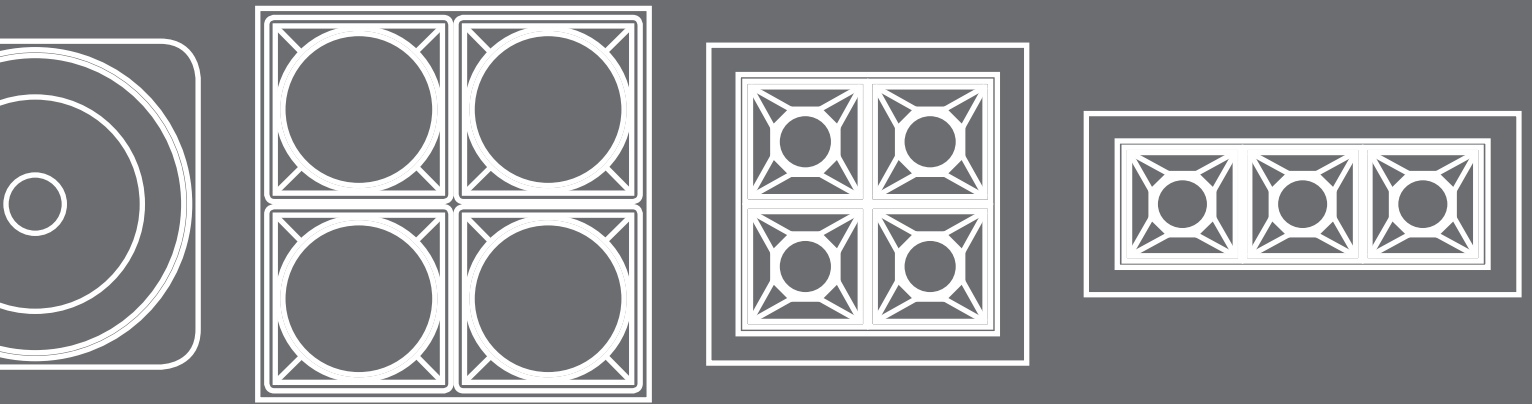

# Simplified



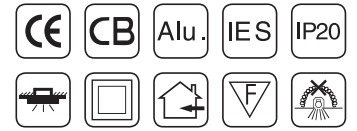

LLL031



LLL033



LLL033A



LLL031A

**PRODUCT PARAMETERS**



Model No.	Power	LED Chip	CRI	Lumens	CCT	Body Color	Beam Angle
LLL031	3W	CREE COB	≥80	153Lm	3000K/4000K	White / Black	8°
LLL033	5W	LUMILEDS	≥90	400Lm	3000K/4000K	White / Black	12°
LLL033A	9W	CREE COB	≥80	600Lm	3000K/4000K	White / Black	24°
LLL031A	3W	CREE COB	≥80	150Lm	3000K/4000K	Sand White	8°

**PRODUCT DIMENSION**

Unit (mm)

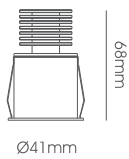

**LLL031-3W**  
Body Size: Ø41\*68mm  
Cut-Size: Ø35mm

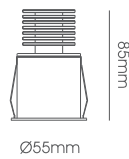

**LLL033-5W**  
Body Size: Ø55\*85mm  
Cut-Size: Ø45mm

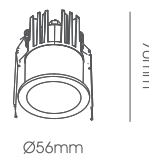

**LLL033A-9W**  
Body Size: Ø56\*70mm  
Cut-Size: Ø48mm

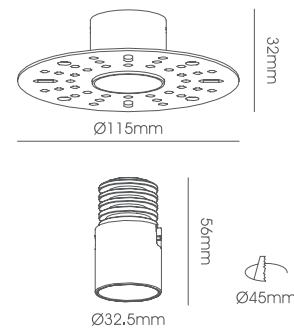

**LLL031A-3W**  
Body Size: Ø115\*56mm  
Cut-Size: Ø45mm

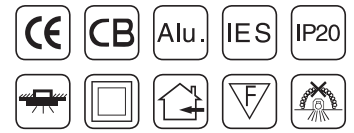

LLL032



LLL034

PRODUCT PARAMETERS



Model No.	Power	LED Chip	CRI	Lumens	CCT	Body Color	Beam Angle
LLL032	3W	BRIDGELUX SMD	≥90	153Lm	3000K/4000K	White / Black	8°
LLL034	5W	CREE SMD	≥90	400Lm	3000K/4000K	White / Black	12°

PRODUCT DIMENSION

Unit (mm)

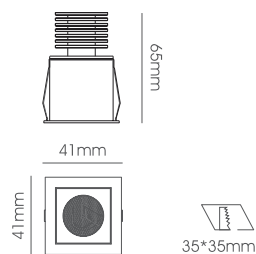

**LLL032-3W**  
Body Size: 41\*41\*65mm  
Cut-Size: 35\*35mm

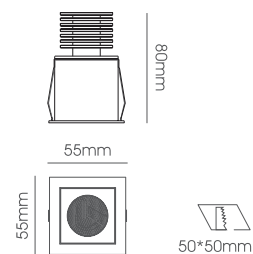

**LLL034-5W**  
Body Size: 55\*55\*80mm  
Cut-Size: 50\*50mm

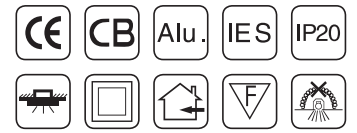

LLL064



LLL065



LLL066

**PRODUCT PARAMETERS**



Model No.	Power	LED Chip	CRI	Lumens	CCT	Body Color	Beam Angle
LLL064	9W	CREE COB	≥80	675-765Lm	3000K/4000K	White / Black	45°
LLL065	18W	CREE COB	≥80	1440Lm	3000K/4000K	White / Black	45°
LLL066	9W	CREE COB	≥80	675-765Lm	3000K/4000K	White / Black	45°

**PRODUCT DIMENSION**

Unit (mm)

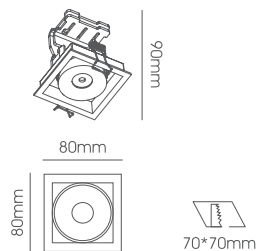
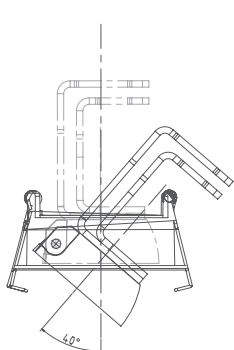

**LLL064-9W**  
Body Size: 80\*80\*90mm  
Cut-Size: 70\*70mm

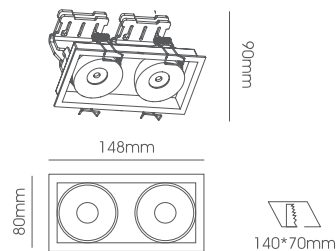

**LLL065-18W**  
Body Size: 148\*80\*90mm  
Cut-Size: 140\*70mm

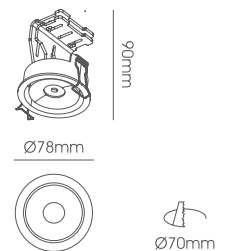

**LLL066-9W**  
Body Size: Ø78\*90mm  
Cut-Size: Ø70mm

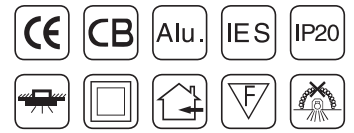

LLL067

LLL068

LLL069

LLL070

LLL071

LLL072

PRODUCT PARAMETERS



Model No.	Power	LED Chip	CRI	Lumens	CCT	Body Color	Beam Angle
LLL067	3W	CREE COB	≥80	80Lm/W	3000K/4000K	White / White+Black	90°
LLL068	6W	CREE COB	≥80	80Lm/W	3000K/4000K	White / White+Black	90°
LLL069	12W	CREE COB	≥80	80Lm/W	3000K/4000K	White / White+Black	90°
LLL070	3W	CREE COB	≥80	80Lm/W	3000K/4000K	White / White+Black	wall washers
LLL071	6W	CREE COB	≥80	80Lm/W	3000K/4000K	White / White+Black	wall washers
LLL072	12W	CREE COB	≥80	80Lm/W	3000K/4000K	White / White+Black	wall washers

PRODUCT DIMENSION

Unit (mm)

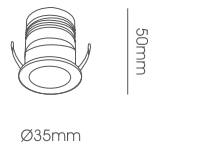

**LLL067-3W**  
Body Size: Ø35\*50mm  
Cut-Size: Ø26mm

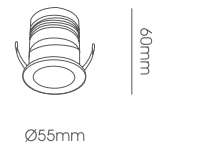

**LLL068-6W**  
Body Size: Ø55\*60mm  
Cut-Size: Ø46mm

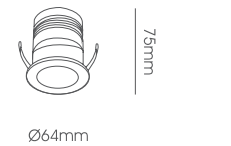

**LLL069-12W**  
Body Size: Ø64\*75mm  
Cut-Size: Ø55mm

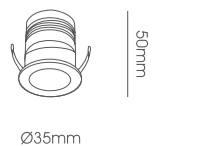

**LLL070-3W**  
Body Size: Ø35\*50mm  
Cut-Size: Ø26mm

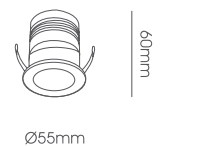

**LLL071-6W**  
Body Size: Ø55\*60mm  
Cut-Size: Ø46mm

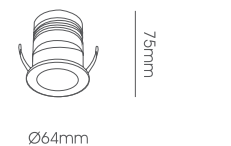

**LLL072-12W**  
Body Size: Ø64\*75mm  
Cut-Size: Ø55mm

**CAN BE MADE TO ORDER**  
DIMMABLE/TUNABLE WITH RF CONTROL

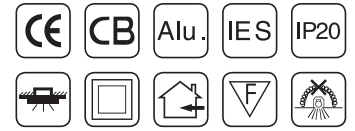

LLL076



LLL077



LLL078

**PRODUCT PARAMETERS**



Model No.	Power	LED Chip	CRI	Lumens	CCT	Body Color	Beam Angle
LLL076	5W	OSRAM COB	≥90	300Lm	3000K/4000K	White / Black	38°
LLL077	12W	OSRAM COB	≥90	720Lm	3000K/4000K	White / Black	38°
LLL078	16W	OSRAM COB	≥90	960Lm	3000K/4000K	White / Black	38°

**PRODUCT DIMENSION**

Unit (mm)



**LLF076-5W**  
Body Size: 55\*55\*45mm  
Cut-Size: 50\*50mm



**LLF077-12W**  
Body Size: 130\*55\*45mm  
Cut-Size: 125\*50mm

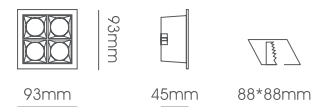

**LLF078-16W**  
Body Size: 93\*93\*45mm  
Cut-Size: 88\*88mm



**CAN BE MADE TO ORDER**  
DIMMABLE/TUNABLE WITH RF CONTROL

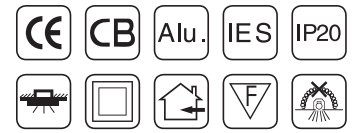

LLL079



LLL080



LLL081

**PRODUCT PARAMETERS**



Model No.	Power	LED Chip	CRI	Lumens	CCT	Body Color	Beam Angle
LLL079	20W	OSRAM COB	≥90	1200lm	3000K/4000K	White / Black	38°
LLL080	36W	OSRAM COB	≥90	2160lm	3000K/4000K	White / Black	38°
LLL081	40W	OSRAM COB	≥90	2400lm	3000K/4000K	White / Black	38°

**PRODUCT DIMENSION**

Unit (mm)

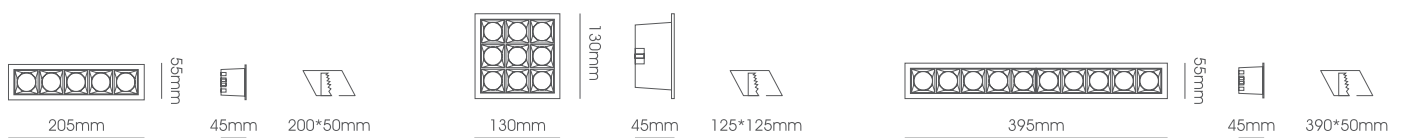

**LLL079-20W**  
Body Size: 205\*55\*45mm  
Cut-Size: 200\*50mm

**LLL080-36W**  
Body Size: 130\*130\*45mm  
Cut-Size: 125\*125mm

**LLL081-40W**  
Body Size: 395\*55\*45mm  
Cut-Size: 390\*50mm

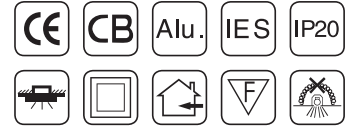

**PRODUCT PARAMETERS**



Model No.	Power	LED Chip	CRI	Lumens	CCT	Body Color	Beam Angle
LLL082	20W	OSRAM COB	≥90	1200Lm	3000K/4000K	White / Black	38°
LLL083	30W	OSRAM COB	≥90	1800Lm	3000K/4000K	White / Black	38°
LLL093	5W	OSRAM COB	≥90	375-425Lm	3000K/4000K	White / Black	38°
LLL094	15W	OSRAM COB	≥90	1125-1275Lm	3000K/4000K	White / Black	38°

**PRODUCT DIMENSION**

Unit (mm)



**LLL082-20W**  
Body Size:  
272\*55\*77mm

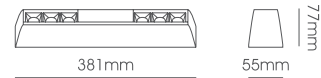

**LLL083-30W**  
Body Size:  
381\*55\*77mm



**LLL093-5W**  
Body Size:  
58\*58\*90mm

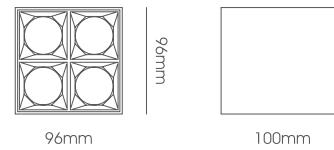

**LLL094-15W**  
Body Size:  
96\*96\*100mm

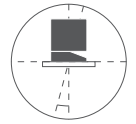
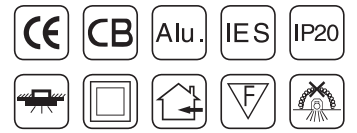

Beam Angle Adjustable



LLL084



LLL084A

PRODUCT PARAMETERS



Model No.	Power	LED Chip	CRI	Lumens	CCT	Body Color	Beam Angle
LLL084	5W	CREE COB	≥80	450-500Lm	3000K/4000K	White	20° -40°
LLL084A	10W	CREE COB	≥80	900-1000Lm	3000K/4000K	White	20° -40°

PRODUCT DIMENSION

Unit (mm)

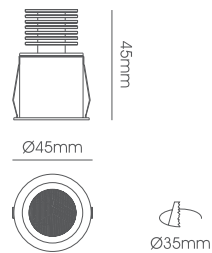

**LLL084-5W**  
Body Size: Ø45\*45mm  
Cut-Size: Ø35mm

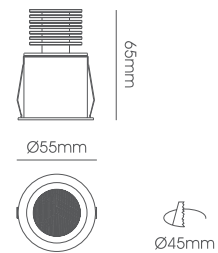

**LLL084A-10W**  
Body Size: Ø55\*65mm  
Cut-Size: Ø45mm

**Dimmable/Tunable**  
With remote/APP

WiFi signal can be used to control the smart home synchronously. It needs to download (Tuya smart) APP to the mobile phone synchronously. The mobile phone can adjust and control the lights of each area according to the need.

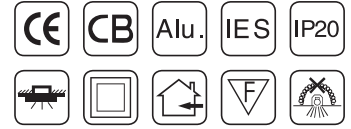

**PRODUCT PARAMETERS**



Model No.	Power	Dimming	Voltage range	LED Chip	CRI	Lumens	Color temperature adjustment	Body Color	Beam Angle
LLL086	7W	1~100%	220-240V	BRIDGELUX COB	≥80	560-630Lm	2700-6500K	White	15°/38°
LLL087	12W	1~100%	220-240V	BRIDGELUX COB	≥80	960-1080Lm	2700-6500K	White	15°/38°
LLL088	20W	1~100%	220-240V	BRIDGELUX COB	≥80	1600-1800Lm	2700-6500K	White	15°/38°

**PRODUCT DIMENSION**

Unit (mm)

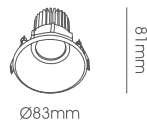

**LLL086-7W**  
Body Size: Ø83\*81mm  
Cut-Size: Ø75mm

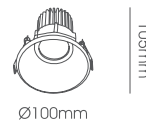

**LLL087-12W**  
Body Size: Ø100\*105mm  
Cut-Size: Ø90mm

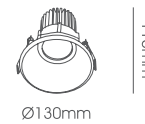

**LLL088-20W**  
Body Size: Ø130\*116mm  
Cut-Size: Ø115mm

Dimmable/Turnable  
With remote/APP

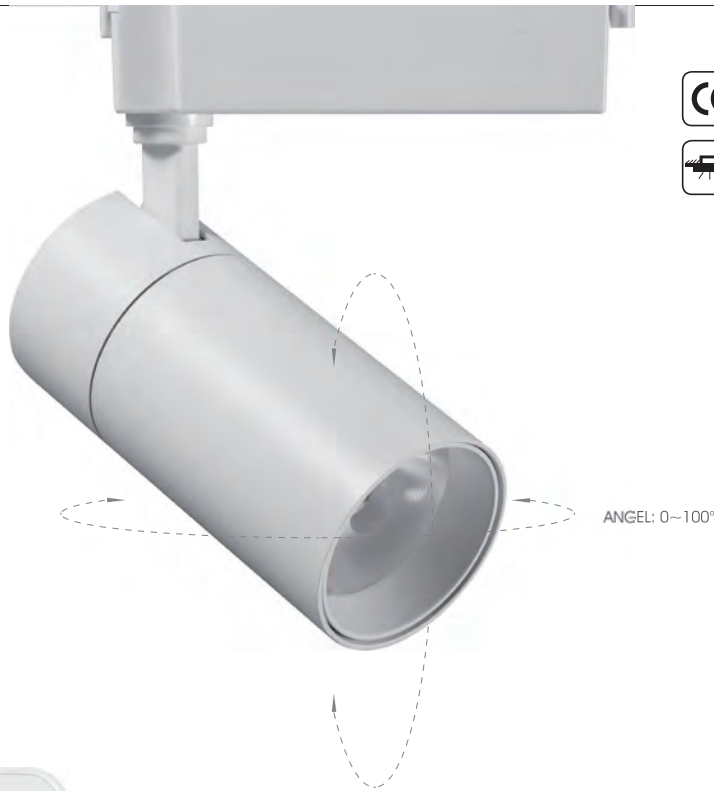
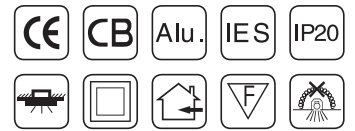

WiFi signal can be used to control the smart home synchronously. It needs to download (Tuya smart) APP to the mobile phone synchronously. The mobile phone can adjust and control the lights of each area according to the need.

### PRODUCT PARAMETERS



Model No.	Power	Dimming	Voltage range	LED Chip	CRI	Lumens	Lamp cup and lens	Color temperature adjustment	Body Color	Beam Angle
LLL089	18W	1-100%	220-240V	BRIDGELUX COB	≥80	1350-1440Lm	DARKOO	2700-6500K	White / Black	15°/24°/36°
LLL090	30W	1-100%	220-240V	BRIDGELUX COB	≥80	2250-2400Lm	DARKOO	2700-6500K	White / Black	15°/24°/36°

### PRODUCT DIMENSION

Unit (mm)

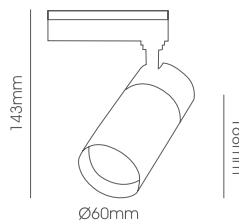

**LLL089-18W**  
Body Size:  
Ø60\*168\*143mm

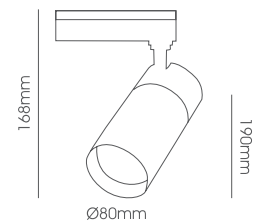

**LLL090-30W**  
Body Size:  
Ø80\*190\*168mm



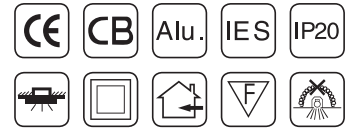

LLL096



LLL097

**PRODUCT PARAMETERS**



Model No.	Power	LED Chip	CRI	Lumens	CCT	Body Color	Beam Angle
LLL096	7W	BRIDGELUX	≥90	509Lm	3000K/4000K	Sand Black + Gold	20°
LLL097	12W	BRIDGELUX	≥90	842Lm	3000K/4000K	Sand Black + Gold	24°

**PRODUCT DIMENSION**

Unit (mm)

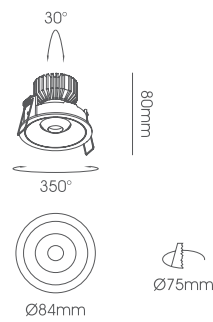

**LLL096-7W**  
Body Size: Ø84\*80mm  
Cut-Size: Ø75mm

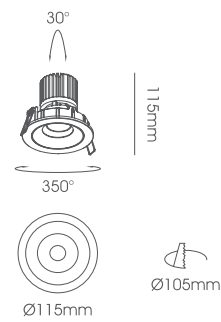

**LLL097-12W**  
Body Size: Ø115\*115mm  
Cut-Size: Ø105mm

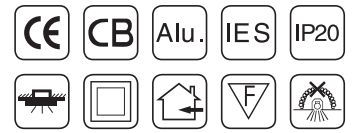

LLL098A



LLL098

PRODUCT PARAMETERS



Model No.	Power	LED Chip	CRI	Lumens	CCT	Body Color	Beam Angle
LLL098	18W	BRIDGELUX COB	≥80	825Lm	3000K	Sand White	30°*50°
LLL098A	10W	BRIDGELUX COB	≥80	520Lm	3000K/4000K/5000K	Sand White	30°*50°

PRODUCT DIMENSION

Unit (mm)

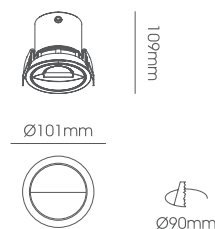

LLL098-18W  
Body Size: Ø101\*109mm  
Cut-Size: Ø90mm

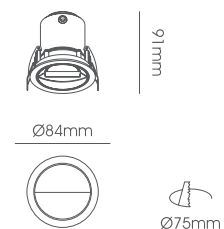

LLL098A-10W  
Body Size: Ø84\*91mm  
Cut-Size: Ø75mm

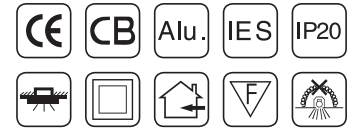

**PRODUCT PARAMETERS**



Model No.	Power	LED Chip	CRI	Lumens	CCT	Body Color	Beam Angle
LLL099	7W	BRIDGELUX COB	≥90	375Lm	3000K/4000K	Sand White	45°
LLL100	12W	BRIDGELUX COB	≥90	740Lm	3000K/4000K	Sand White	45°
LLL100A	18W	BRIDGELUX COB	≥90	1180Lm	3000K/4000K	Sand White	45°

**PRODUCT DIMENSION**

Unit (mm)

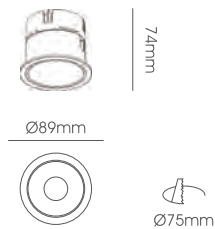

**LLL099-7W**  
Body Size: Ø89\*74mm  
Cut-Size: Ø75mm

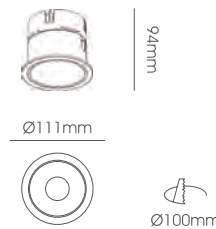

**LLL100-12W**  
Body Size: Ø111\*94mm  
Cut-Size: Ø100mm

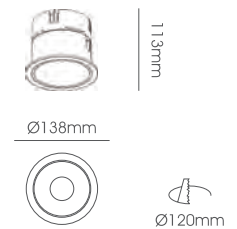

**LLL100A-18W**  
Body Size: Ø138\*113mm  
Cut-Size: Ø120mm

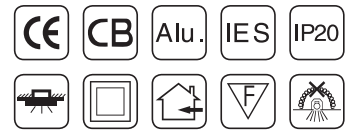

LLL011



LLL012



LLL013



LLL014

PRODUCT PARAMETERS



Model No.	Power	LED Chip	CRI	Lumens	CCT	Body Color	Beam Angle
LLL011	7W	LUMENS DOB	≥90	470Lm	3000K/4000K	Black+Glod	24°
LLL012	7W	LUMENS DOB	≥90	470Lm	3000K/4000K	Black+Glod	24°
LLL013	7W	CREE COB	≥80	400Lm	3000K/4000K	White / Black	24°
LLL014	2*7W	CREE COB	≥80	800Lm	3000K/4000K	White / Black	24°

PRODUCT DIMENSION

Unit (mm)

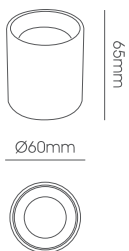

LLL011-7W  
Body Size:  
Ø60\*65mm

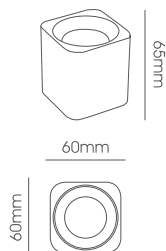

LLL012-7W  
Body Size:  
60\*60\*65mm

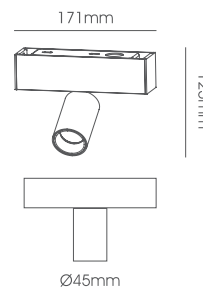

LLL013-7W  
Body Size:  
Ø45\*171\*125mm

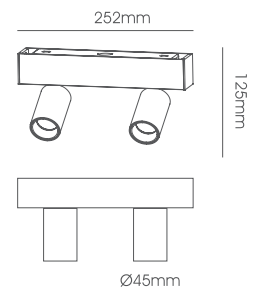

LLL014-2\*7W  
Body Size:  
Ø45\*252\*125mm

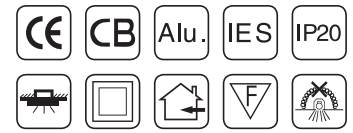

LLL015



LLL016



LLL020

**PRODUCT PARAMETERS**



Model No.	Power	LED Chip	CRI	Lumens	CCT	Body Color	Beam Angle
LLL015	3*2W	CREE COB	≥80	350lm	3000K/4000K	Sand Black	8°
LLL016	4*2W	CREE COB	≥80	460lm	3000K/4000K	Sand Black	8°
LLL020	6*2W	BRIDGELUX COB	≥90	739lm	3000K/4000K	Sand Black	8°

**PRODUCT DIMENSION**

Unit (mm)

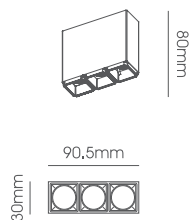

**LLL015-3\*2W**  
Body Size:  
90.5\*30\*80mm

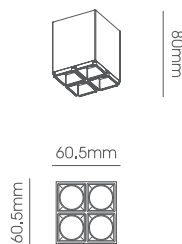

**LLL016-4\*2W**  
Body Size:  
60.5\*60.5\*80mm

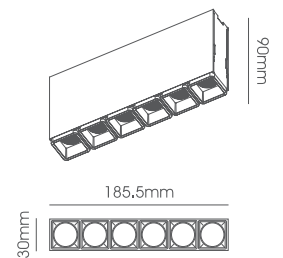

**LLL020-6\*2W**  
Body Size:  
185.5\*30\*90mm



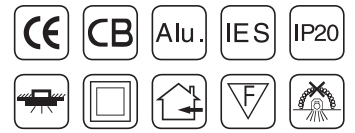

LLL015A



LLL016A



LLL019

PRODUCT PARAMETERS



Model No.	Power	LED Chip	CRI	Lumens	CCT	Body Color	Beam Angle
LLL015A	3*2W	BRIDGELUX	≥90	400Lm	3000K/4000K	Sand Black	8°
LLL016A	4*2W	BRIDGELUX	≥90	500Lm	3000K/4000K	Sand Black	8°
LLL019	6*2W	BRIDGELUX	≥90	739Lm	3000K/4000K	Sand Black	8°

PRODUCT DIMENSION

Unit (mm)

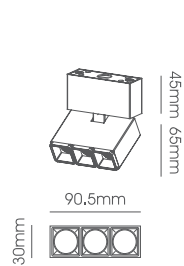

LLL015A-3\*2W  
Body Size:  
90.5\*30\*110mm

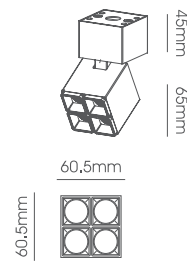

LLL016A-4\*2W  
Body Size:  
60.5\*60.5\*110mm

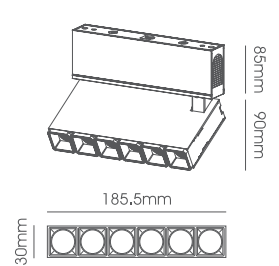

LLL019-6\*2W  
Body Size:  
185.5\*30\*175mm

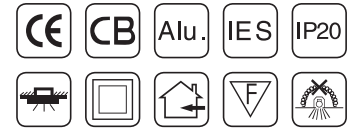

**PRODUCT PARAMETERS**



Model No.	Power	LED Chip	CRI	Lumens	CCT	Body Color	Beam Angle
LLL125	5W	Bridgelux	≥90	310Lm	3000K/4000K	Sand Black	65°+26°<18°
LLL126	2*5W	Bridgelux	≥90	686Lm	3000K/4000K	Sand Black	65°+26°<18°
LLL127	3*5W	Bridgelux	≥90	1086Lm	3000K/4000K	Sand Black	100°X2+65°<18°X2

**PRODUCT DIMENSION**

Unit(mm)

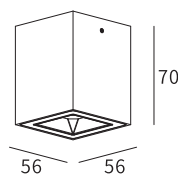

LLL 125-5W  
Body Size :56\*56\*70

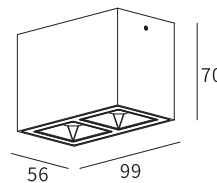

LLL 126-2\*5W  
Body Size :99\*56\*70

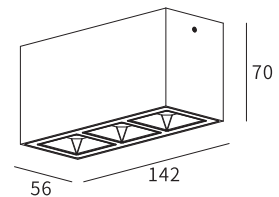

LLL 127-3\*5W  
Body Size :142\*56\*70

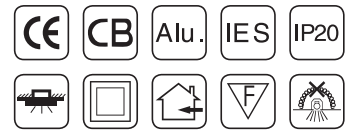

LLL095



LLL095A



LLL095B

PRODUCT PARAMETERS



Model No.	Power	LED Chip	CRI	Lumens	CCT	Body Color	Beam Angle
LLL095	5W	BRIDGELUX	≥90	373Lm	3000K	Sand Black	20
LLL095A	5W	BRIDGELUX	≥90	373Lm	3000K	Sand Black	20
LLL095B	5W	BRIDGELUX	≥90	373Lm	3000K	Sand Black	20

PRODUCT DIMENSION

Unit (mm)

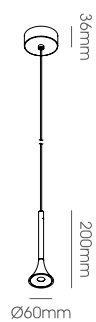

LLL095-5W  
Body Size:  
Ø60\*200mm

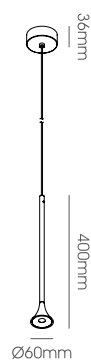

LLL095A-5W  
Body Size:  
Ø60\*400mm

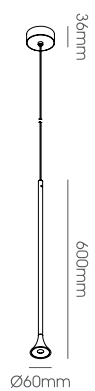

LLL095B-5W  
Body Size:  
Ø60\*600mm

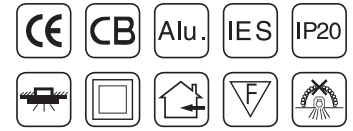

LLL123



LLL124

**PRODUCT PARAMETERS**



Model No.	Power	LED Chip	CRI	Lumens	CCT	Body Color	Beam Angle
LLL123	7W	BRIDGELUX	≥90	160lm	3000K	Sand Black	/
LLL124	9W	BRIDGELUX	≥90	440lm	3000K	Sand Black	/

**PRODUCT DIMENSION**

Unit (mm)

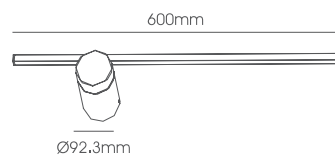

**LLL123-7W**  
Body Size:  
Ø92.3\*600mm

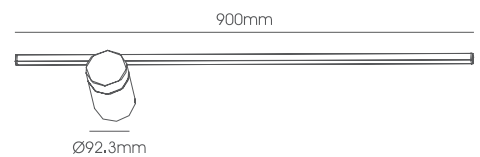

**LLL124-9W**  
Body Size:  
Ø92.3\*900mm

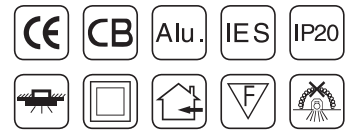

LLL120



LLL121



LLL122

PRODUCT PARAMETERS



Model No.	Power	LED Chip	CRI	Lumens	CCT	Body Color	Beam Angle
LLL120	1W	EDISON SMD	≥80	/	3000K/4000K	Mat White	/
LLL121	3W	CREE SMD	≥80	/	3000K/4000K	Mat White	/
LLL122	3W	BRIDGELUX SMD	≥90	/	3000K/4000K	Mat White	/

PRODUCT DIMENSION

Unit (mm)

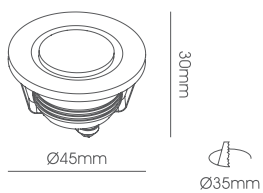

LLL120-1W  
Body Size: Ø45\*109mm  
Cut-Size: Ø35mm

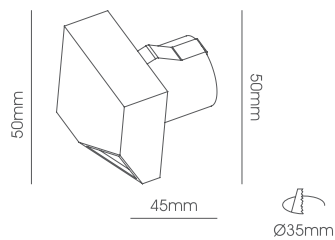

LLL121-3W  
Body Size: 50\*50\*45mm  
Cut-Size: Ø35mm

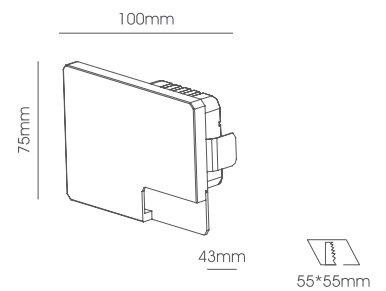

LLL122-3W  
Body Size: 100\*75\*43mm  
Cut-Size: 55\*55mm





---

IMPORTED AND MARKETED BY/CUSTOMER CARE ADDRESS  
LED Lum Lighting Solutions LLP

#22A,7<sup>th</sup> Street,Sector3,Ambattur Industrial Estate,  
Ambattur,Chennai-600098

Landline : +91 44 4852 8068, 4852 8069,

Mobile : +91 97907 99997, Customer Care : +91 96631 02951,

Email : [ledlumlighting@gmail.com](mailto:ledlumlighting@gmail.com), Web : [www.ledlumlighting.com](http://www.ledlumlighting.com)