



**HAVELLS**



Premium Ventilation Solutions  
Feel the Power of Silence..





## About Havells

Havells as a brand has become synonymous with impeccable quality and state-of-the-art technology. Our core philosophy of “nothing but the best” for our consumers is evident through our vast portfolio that includes not only high-end domestic products but also cutting-edge industrial solutions. Our products have been designed to meet all consumer needs without compromising on quality.

Keeping in line with the core philosophy, our new range of premium ventilation fans, Vento, is a must-have for every home. What makes the Vento series irresistible is not just its high suction capacity but also its nearly silent operation. It comes with a 2-year guarantee and has been crafted to ensure that your home remains fresh and healthy.





## Premium Ventilation Solutions Feel the Power of Silence...

The highly innovative, state-of-the-art Vento series is designed to complement your home interiors. It has smooth and silent operation. Enjoy a perfect balance of design and performance with Havells Vento series.

European Certification



# Vento Series



# Vento Jet - Auto Inox

- Sweep 100 mm & 150 mm
- Brushed steel finish
- Automatic front shutter
- High suction capacity
- Silent operation
- Wall, ceiling and glass mounting
- Removable screwless front for easy cleaning



## Technical Specifications

Sweep	Power Input	Speed	Air Delivery	Rated Voltage	Rated Frequency	Noise Level
100 mm	15 W	2500 r/min (RPM)	98 m <sup>3</sup> /h	220-240 V	50 Hz	38 dB
150 mm	25 W	2200 r/min (RPM)	320 m <sup>3</sup> /h	220-240 V	50 Hz	42 dB

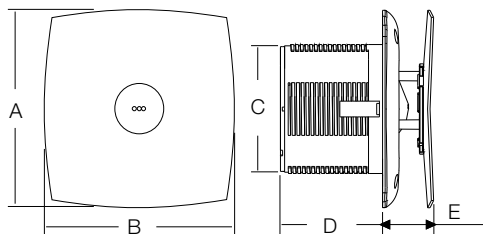

Sweep	A	B	C	D	E
100 mm	150	150	98	89.5	31
150 mm	194	194	148	124	38

All dimensions are in mm.

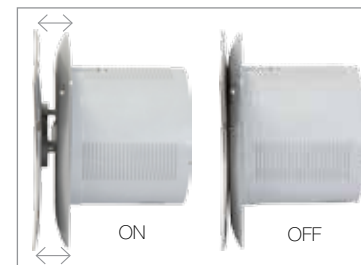



# Vento Jet - Auto

- Sweep 100 mm & 150 mm
- Off-white color
- Automatic front shutter
- High suction capacity
- Silent operation
- Wall, ceiling and glass mounting
- Removable screwless front for easy cleaning



## Technical Specifications

Sweep	Power Input	Speed	Air Delivery	Rated Voltage	Rated Frequency	Noise Level
100 mm	15 W	2500 r/min (RPM)	98 m <sup>3</sup> /h	220-240 V	50 Hz	38 dB
150 mm	25 W	2200 r/min (RPM)	320 m <sup>3</sup> /h	220-240 V	50 Hz	42 dB

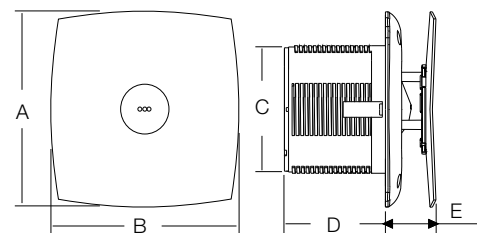

Sweep	A	B	C	D	E
100 mm	150	150	98	89.5	31
150 mm	194	194	148	124	38

All dimensions are in mm.

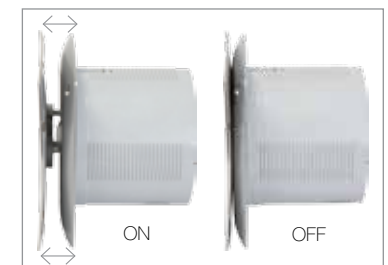



# Vento Jet - Inox

- Sweep 100 mm & 150 mm
- Brushed steel finish
- Modular concept
- High suction capacity
- Silent operation
- Wall, ceiling and glass mounting
- Removable screwless front for easy cleaning



## Technical Specifications

Sweep	Power Input	Speed	Air Delivery	Rated Voltage	Rated Frequency	Noise Level
100 mm	15 W	2500 r/min (RPM)	98 m³/h	220-240 V	50 Hz	38 dB
150 mm	25 W	2200 r/min (RPM)	320 m³/h	220-240 V	50 Hz	42 dB

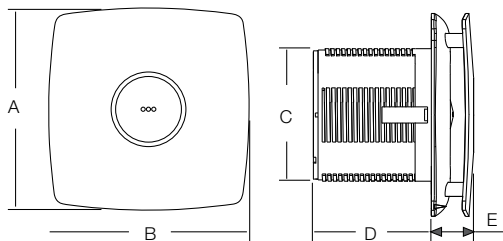

Sweep	A	B	C	D	E
100 mm	150	150	98	98.5	38
150 mm	194	194	148	124	34

All dimensions are in mm.



# Vento Jet

- Sweep 100 mm & 150 mm
- Off-white color
- Modular concept
- High suction capacity
- Silent operation
- Wall, ceiling and glass mounting
- Removable screwless front for easy cleaning



## Technical Specifications

Sweep	Power Input	Speed	Air Delivery	Rated Voltage	Rated Frequency	Noise Level
100 mm	15 W	2500 r/min (RPM)	98 m <sup>3</sup> /h	220-240 V	50 Hz	38 dB
150 mm	25 W	2200 r/min (RPM)	320 m <sup>3</sup> /h	220-240 V	50 Hz	42 dB

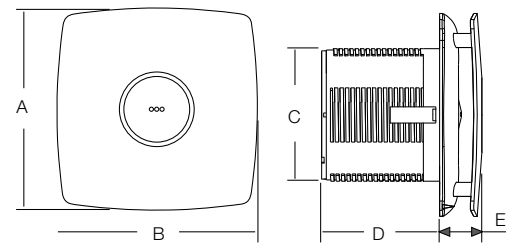

Sweep	A	B	C	D	E
100 mm	150	150	98	98.5	38
150 mm	194	194	148	124	34

All dimensions are in mm.





# Ventilation (Plastic) Series



# Ventilair DX-C

- Sweep 130 mm
- Modern design & elegant look
- Ideal for centrally air conditioned bathrooms and mounting on ceiling



## Technical Specifications

Sweep	Power Input	Speed	Air Delivery	Rated Voltage	Rated Frequency	Noise Level
130 mm	24 W	1760 r/min (RPM)	150 m <sup>3</sup> /h	220-240 V	50 Hz	42 dB

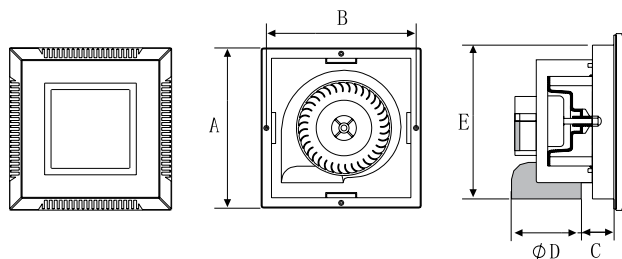

Sweep	A	B	C	D	E
130 mm	264	242	33.5	97	228

All dimensions are in mm.







# DXW Celso

- Sweep 150 mm & 200 mm
- Modern looks and sleek design for easy fitting
- Ideal for mounting on glass
- Pull cord for fan switch on-off and shutter open-close
- Shutter to prevent entry of insects, pest and rodents



## Technical Specifications

Sweep	Power Input	Speed	Air Delivery	Rated Voltage	Rated Frequency	Noise Level
150 mm	15 W	1350 r/min (RPM)	150 m³/h	220-240 V	50 Hz	38 dB
200 mm	20 W	1550 r/min (RPM)	250 m³/h	220-240 V	50 Hz	42 dB

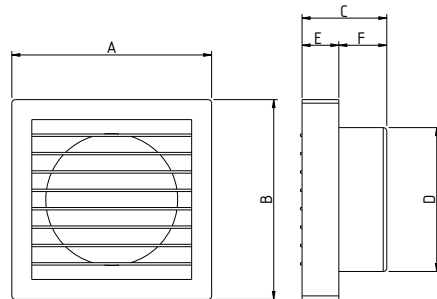

Sweep	A	B	C	D	E	F
150 mm	198	198	90	148	35	55
200 mm	250	250	106	180	46	60

All dimensions are in mm.



# Ventilair DX-WT

- Sweep 150 mm
- Thermally operated automated front shutter
- Noise free operation
- Suitable for window and wall mounted indoor installation
- Modern design, fashionable and elegant look



## Technical Specifications

Sweep	Power Input	Speed	Air Delivery	Rated Voltage	Rated Frequency	Noise Level
150 mm	25 W	1760 r/min (RPM)	300 m³/h	220-240 V	50 Hz	45 dB

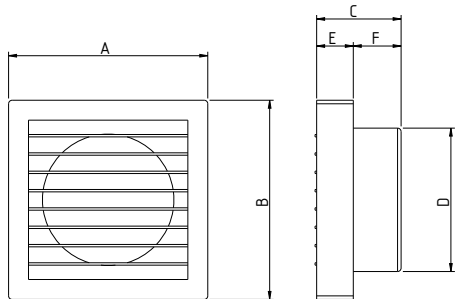

Sweep	A	B	C	D	E	F
150 mm	208	208	120	146	58	62

All dimensions are in mm.

Note: Also available with electrically operated automatic shutter (DX-WE)



# Ventilair DX-WE

- Sweep 150 mm
- Modern design, fashionable and elegant look
- Suitable for window & wall mounted indoor installation
- Electrically operated automated front shutter



## Technical Specifications

Sweep	Power Input	Speed	Air Delivery	Rated Voltage	Rated Frequency	Noise Level
150 mm	25 W	1760 r/min (RPM)	300 m <sup>3</sup> /h	220-240 V	50 Hz	45 dB

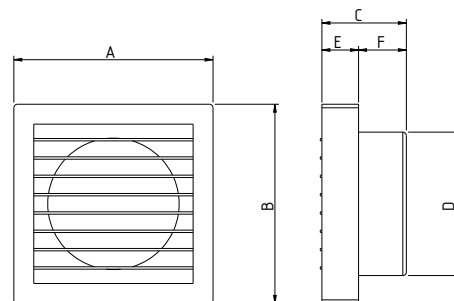

Sweep	A	B	C	D	E	F
150 mm	208	208	120	146	58	62

All dimensions are in mm.

Note: Also available with thermally operated automatic shutter (DX-WT)

# Ventilair DXW Neo

- Sweep 150 mm
- Easy installation on glass window & wood panels
- Powerful air suction for clean and odorless air



## Technical Specifications

Sweep	Power Input	Speed	Air Delivery	Rated Voltage	Rated Frequency	Noise Level
150 mm	25 W	2000 r/min (RPM)	300 m³/h	220-240 V	50 Hz	45 dB

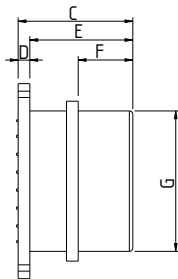
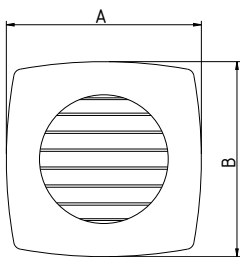

Sweep	A	B	C	D	E	F	G
150 mm	208	208	132	8	124	70	147

All dimensions are in mm.





# Ventilair DXW

- Sweep 100 mm & 150 mm
- Modern design, fashionable & elegant look
- Ideal for mounting on glass window & wood panels



## Technical Specifications

Sweep	Power Input	Speed	Air Delivery	Rated Voltage	Rated Frequency	Noise Level
100 mm	15 W	2400 r/min (RPM)	100 m <sup>3</sup> /h	220-240 V	50 Hz	43 dB
150 mm	25 W	2000 r/min (RPM)	300 m <sup>3</sup> /h	220-240 V	50 Hz	45 dB

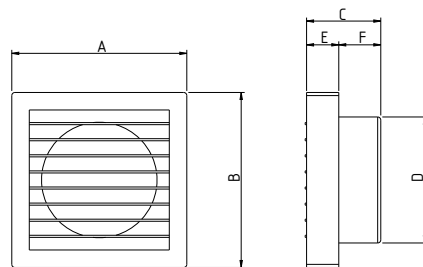

Sweep	A	B	C	D	E	F
100 mm	150	150	81	97	35	46
150 mm	208	208	106	146	46	60

*All dimensions are in mm.*



# Ventilair DXR

- Sweep 150 mm
- Back shutter & fan "on-off" operations are inter-locked through pull cord
- Easy installation on glass & wood panels



## Technical Specifications

Sweep	Power Input	Speed	Air Delivery	Rated Voltage	Rated Frequency	Noise Level
150 mm	25 W	1800 r/min (RPM)	300 m <sup>3</sup> /h	220-240 V	50 Hz	45 dB

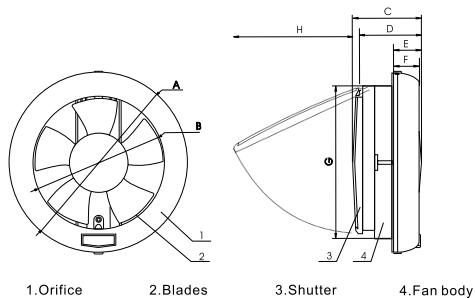

Sweep	A	B	C	D	E	F	G	H
150 mm	210	150	80	72	35	32	180	142

All dimensions are in mm.



# Ventilair Hush

- Sweep 100 mm & 150 mm
- Modular concept
- High suction capacity
- Noiseless operation
- Removable front plate for easy cleaning



## Technical Specifications

Sweep	Power Input	Speed	Air Delivery	Rated Voltage	Rated Frequency	Noise Level
100 mm	15 W	2450 r/min (RPM)	140 m <sup>3</sup> /h	220-240 V	50 Hz	35 dB
150 mm	25 W	2000 r/min (RPM)	275 m <sup>3</sup> /h	220-240 V	50 Hz	40 dB

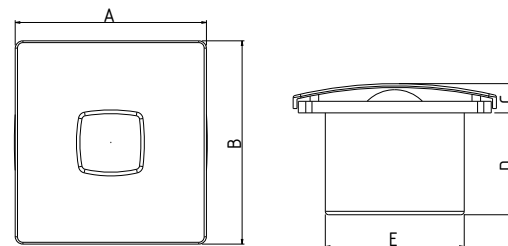

Sweep	A	B	C	D	E
100 mm	150	150	27	72	98
150 mm	200	200	28	94	145

All dimensions are in mm.

# Ventilair DXZ

- Sweep 100 & 150 mm
- Easy installation on glass / window panels
- High quality plastic, resistant to colour change
- Elegant front grill
- Also available in black color



## Technical Specifications

Sweep	Power Input	Speed	Air Delivery	Rated Voltage	Rated Frequency	Noise Level
100 mm	18 W	2500 r/min (RPM)	90 m <sup>3</sup> /h	220-240 V	50 Hz	43 dB
150 mm	22 W	1800 r/min (RPM)	250 m <sup>3</sup> /h	220-240 V	50 Hz	45 dB

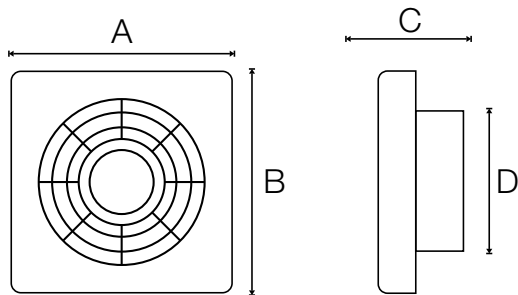

Sweep	A	B	C	D
100 mm	165	165	115	98
150 mm	185	190	115	148

All dimensions are in mm.



# Ventilair DX

- Sweep 150 mm, 200 mm & 250 mm
- Ideal for mounting on wood
- High quality engineering plastic, resistant to colour change with anti-static properties



## Technical Specifications

Sweep	Power Input	Speed	Air Delivery	Rated Voltage	Rated Frequency	Noise Level
150 mm	22 W	1350 r/min (RPM)	280 m <sup>3</sup> /h	220-240 V	50 Hz	34 dB
200 mm	32 W	1350 r/min (RPM)	520 m <sup>3</sup> /h	220-240 V	50 Hz	42 dB
250 mm	35 W	1200 r/min (RPM)	860 m <sup>3</sup> /h	220-240 V	50 Hz	44 dB

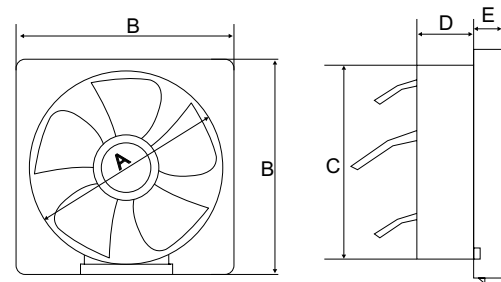

Sweep	A Dia	B	C	D	E
150 mm	150	241	172	73	50
200 mm	200	298	240	90	40
250 mm	250	348	290	90	48

All dimensions are in mm.





Ventilation (Metal) Series



# Ventilair DB Neo

- Sweep 230 mm & 300 mm
- Sturdy steel bird guard
- Propeller type metal blade
- Trouble free continuous operation
- Double ball bearing heavy duty motor

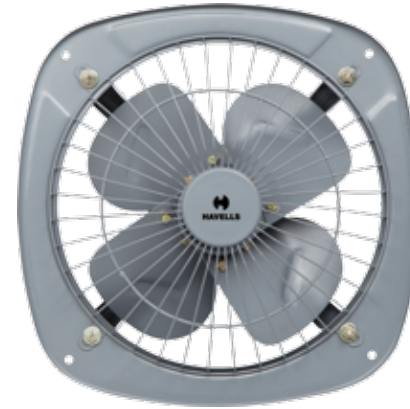

## Technical Specifications

Sweep	Power Input	Speed	Air Delivery	Rated Voltage	Rated Frequency	Noise Level
230 mm	45 W	1450 r/min (RPM)	870 m <sup>3</sup> /h	220-240 V	50 Hz	45-50 dB
300 mm	70 W	1400 r/min (RPM)	1600 m <sup>3</sup> /h	220-240 V	50 Hz	45-50 dB





## Ventilair DB

- Sweep 230 mm & 300 mm
- Double ball bearings
- Heavy duty motor
- Protective steel bird guard
- Robust construction



## Technical Specifications

Sweep	Power Input	Speed	Air Delivery	Rated Voltage	Rated Frequency	Noise Level
230 mm	45 W	1400 r/min (RPM)	860 m <sup>3</sup> /h	220-240 V	50 Hz	45-50 dB
300 mm	70 W	1400 r/min (RPM)	1850 m <sup>3</sup> /h	220-240 V	50 Hz	45-50 dB



# Ventilair DS

- Sweep 150 mm, 230 mm & 300 mm
- Specially designed metal blade
- Powder coated long lasting finish
- Sturdy steel bird guard



## Technical Specifications

Sweep	Power Input	Speed	Air Delivery	Rated Voltage	Rated Frequency	Noise Level
150 mm	38 W	2800 r/min (RPM)	400 m <sup>3</sup> /h	220-240 V	50 Hz	45-50 dB
230 mm	35 W	1400 r/min (RPM)	800 m <sup>3</sup> /h	220-240 V	50 Hz	45-50 dB
300 mm	40 W	1400 r/min (RPM)	1060 m <sup>3</sup> /h	220-240 V	50 Hz	45-50 dB





## Ventilair DSP

- Sweep 230 mm & 300 mm
- Specially designed metal blade
- Powder coated long lasting finish
- Sturdy steel bird guard



## Technical Specifications

Sweep	Power Input	Speed	Air Delivery	Rated Voltage	Rated Frequency	Noise Level
230 mm	40 W	1350 r/min (RPM)	510 m <sup>3</sup> /h	220-240 V	50 Hz	45-50 dB
300 mm	50 W	1350 r/min (RPM)	900 m <sup>3</sup> /h	220-240 V	50 Hz	45-50 dB



#### REGIONAL & BRANCH OFFICES:

**NORTH - REGIONAL OFFICE: Corporate Office:** QRG Towers, 2D, Sector-126, Expressway, Noida-201304, Tel: 0120-3331000, **Delhi:** Tel: 011-47676700, 23888200, **Chandigarh:** Tel: 0172-4232400-401, **Dehradun:** Tel: 0135-6670202, **Noida / Haryana:** Tel: 0120-3331000, **Ludhiana:** Tel: 0161-4676000 / 24, **Jammu:** Tel: 0191-2478330, 2479330, **Sri Nagar:** Tel: 0194-2490431, **Jaipur:** Tel: 0141-3914645, 3988210 **Jodhpur:** Tel: 0291-9214201640 / 45, **Lucknow:** Tel: 0522-6672100, **Kanpur:** Tel: 0512-6710400, 6710409

**EAST - REGIONAL OFFICE: Kolkata:** ICC Tower, 5th Floor, 4 India Exchange Place, Kolkata-700001, Tel: 033-40129851/ 52, **Bhubaneshwar:** Tel: 0674-6668101/102/103/104, **Guwahati:** Tel: 0361-2134521, 2458923, 2460355, **Siliguri:** Tel: 0353-2525907, **Ranchi:** 0651-2244861, 2244862, 2244864, 2244868, 2244869, **Jamshedpur:** Tel: 0657-6542492, 09234369436, **Patna:** Tel: 0612-2207221, 2207222, 2207223, 2655518

**WEST - REGIONAL OFFICE: Mumbai:** 1271, Solitaire Corporate Park, Bldg. No. 12, 7th Floor, Andheri - Ghatkopar Link Road, Chakala, Andheri (East), Mumbai- 400093. Ph.: 022 - 67298600-602, **Ahmedabad:** Tel: 079-40061111, 40060738-740, **Indore:** Tel: 0731-2572340-41, 4009998 (Airtel), **Rajkot:** Tel: 0281-2481112, 2921212, **Nagpur:** Tel: 0712-2240932, 2242692, 2242699, **Pune:** Tel: 020-64016413 / 14, **Raipur:** Tel: 0771-4243400 / 01, **Surat:** Tel: 0261-2350137, 9979890137, **Jabalpur:** Tel: 0761-4064491

#### SOUTH - REGIONAL OFFICE:

**Chennai:** Sigapi Achi Building, No. 18 / 3, 6th Floor, Rukmani Lakshmi Pathy Road, Egmore, Chennai-600008, Tel: 044-42280600, 605, **Bangalore:** Tel: 080-49075000, **Coimbatore:** Tel: 0422-4550200, 2305199, 2306199, **Hyderabad:** Tel: 040-27533372, 27533355, 27533632, 66320407/0408/6401/6402, **Kochi:** Tel: 0484-4099000, **Vishakapatnam:** Tel: 0891-6514339, **Vizag:** Tel: 0891-6514339, **Vijayawada:** Tel: +91-9247058847/57, **Calicut:** 0495-4019194, **Madurai:** 0452-4267022, **Trivandrum:** 0471-4015323, **Hubli:** 0836-4248600, **Trichy:** 09944460160

Representative Offices: • Goa • Solapur • Gwalior • Kathmandu • Bhopal

Due to continuous technology upgradation the design & specifications may vary without notice. The colour of the fan shown may differ from the actual fan colour due to printing limitations. Copyright Subsists. Imitation of trade dress, graphics and color scheme of this document is a punishable offence

Scan the QR Code  
to download  
**Havells mCatalogue**



Havells India Ltd.  
QRG Tower, 2D, Sector-126, Expressway, Noida - 201 304. U.P. (INDIA)  
E-mail: marketing@havells.com, Website: www.havells.com  
Consumer Care No.: 1800 11 0303 (Toll Free), 1800 103 1313 (All Connections) 011-4166 0303 (Landline)  
Join us on Facebook at www.facebook.com/havells & share your ways to save the planet!  
CIN - L31900DL1983PLC016304

