



---

# Crompton

FANS CATALOGUE **2022**

---

**Crompton**



LET'S  
HANGOUT  
GHAR PE!

## **Dear Customer,**

We thank you for choosing Crompton as your preferred brand for fulfilling your décor choices. We are delighted that you are now part of the Crompton legacy!

Our products are crafted with an obsession to detail and have featured industry leading innovations like Anti-Dust fans and Duratech technology.

In this catalogue you will find our latest range of innovations from the Energion series of fans with energy saving BLDC motors to SilentPro range of fans that provide silent operations.

We have also included a section to help you chose the recommended design and color for your home décor.

Happy surfing !

## About Us

For more than 75 years, our brand has stood for trust, reliability, dependability and excellence in the area of electrical engineering. We endeavour to provide meaningful benefits, ease of use, great design, superior performance and durability at the right price for our customers. Our range of innovative products caters to modern consumer needs like easy to clean (Anti-Dust) Fans, easy to maintain Air Coolers, Hygienic Lighting Solutions (Anti-Bac LEDs), Pumps and many more.

Today, we are a **Proud Indian Brand and a Market Leader\* in the Category of Fans** with a strong presence in the other categories like pumps, water heaters, air coolers, kitchen appliances and lighting.

\*As per 3rd party retail audit and industry data.

**PROUDLY MADE IN INDIA**

### OUR RANGE OF INNOVATIVE PRODUCTS



**SILENTPRO**

**2X MORE SILENT\*  
THAN REGULAR FANS**



**ENERGION**



\* Up to 50% Energy Saving as compared to a regular ceiling fan operating at the same RPM.

\* Most regular ceiling fans operate at 64dB. Every increase of 10 dB in noise level is perceived to be twice as loud.

\* SilentPro operates at 52dB level thereby making it twice more silent than its conventional counterparts.

\* Due to continuous product improvement, the product illustrated may vary slightly from the actual product.



# Awards and Recognitions

We are delighted to be awarded the National Energy Conservation Award - 6 YEARS IN A ROW!

Crompton is also awarded the Global Safety Award 2020 for Outstanding Achievement in practicing Excellent Workplace Culture in Health & Safety.



# Ranked No.1 by Consumer Voice



Crompton's Star 220 ceiling fan was ranked No.1 and the only fan that delivers on the BEE 5 Star rating for energy efficiency by Consumer Voice\*.

\*Consumer Voice is an independent organisation that conducts independent, comparative and unbiased product trials recognized by the Ministry of Consumer Affairs.

\*National Energy Conservation Award (NECA) is given every year for exceptional achievement in Energy Efficiency. This is awarded by Bureau of Energy Efficiency under Ministry of Power, Govt. of India to Appliances (Refrigerator, AC, Pump, DT, LED, Bulb, Storage Water Heater, CTV, Ceiling Fans). This year our model "HS Plus" which is 5 Star Rated Ceiling Fan has been declared the most Energy Efficient Appliance of the Year in Ceiling Fan Category. This is based on Power Rating, Production & Sales Nos. from Jul 18 to Jun 19.



## Manufacturing Excellence

With improving Consumer preferences and to meet the ever increasing market demand of Crompton's durable products, we have multiple state-of-the-art manufacturing facilities at Goa & Baddi which employ the most modern technologies such as Automated Stator winding and Die Casting units which offer best in class products with highest quality standards.

# Innovations driven by R&D and Consumer Research

For more than 8 decades, Crompton is known for trust, reliability and durability of its fans and is crowned as the pioneer in fan motor technology.

We leverage our robust R&D processes and capabilities, which are further enhanced by our close consumer connect - to offer superior technology based lifestyle solutions.

## Innovation over the years

**2016**



### Anti-Dust fans:

Fans with Dust-resistant Nano technology paint for hassle free cleaning and 50% less dust.

**2017**



### Air 360 fans:

Aerodynamic blades with Anti-drag design for smoother air flow and 50% more coverage.

**2018**



### VSense fans:

Fans with Smart Sensor technology which rotates at High Speed in low voltage conditions.

**2019**



### Duratech fans:

Fans with Premium components & 5-year warranty designed to deliver superlative performance.

**2020**



### Energion fans:

Energy Efficient fans with ActivBLDC motor that save up to 50% Electricity costs

**2020**



### SilentPro fans:

Elite range of fans with aerodynamic ABS body with Silent Operation & Energy Efficient ActivBLDC motor.

**2021**



### Smart fans:

Fans that are operated using mobile application, voice control devices and remote.



# Fan Selection Guide

## Step 1

Compare your décor



## Step 2

Select Fan Model  
Select Fan colour



## Step 3

Browse through the  
technical details



## Selection tips - Ceiling Fans

### Tip 1:

Match your ceiling colour with your fan colour to make the room look spacious.

### Tip 2:

To accentuate your ceiling choose the contrasting furniture colour for your fan.

### Tip 3:

Metallic trims in fan go well with décor that have shiny elements within the space.

### Tip 4:

Decorated fans complement spaces with classic or luxurious settings.

### Tip 5:

For spaces with high maintenance, choose our anti dust ceiling fans range.

### Tip 6:

For places where you need quiet comfort, choose silent operation fans.

### Tip 7:

For spaces with continual requirement of fan, choose energy efficient fans.

### Tip 8:

For usage comfort and convenience, choose Smart (IoT enabled) fans.

# Technical Advice

## Ceiling Fan Selection

How to select your fan?

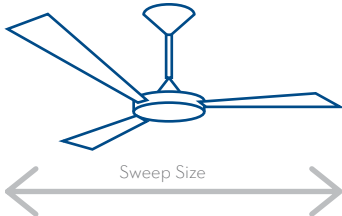

Sweep Size is referred to the entire diameter of a fan.

Speed (RPM)	Air Delivery (CFM)
315	240

Higher RPM does not mean higher air flow. Air flow / Air delivery is the only point of comparison in selecting a ceiling fan.

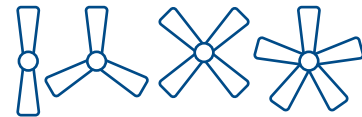

More fan blades do not give better air flow.

A four or five blade ceiling fan provides a more conventional, balanced look, whereas a fan with two or three blades possesses a modern and sleek style.

Sweep Size	Room Size
600 mm (24")	Small shop, cabin or Powder Room
750 mm (30")	6 X 10 ft
900 mm (36")	7 X 10 ft
1050 mm (42")	10 X 10 ft
1200 mm (48")	12 X 13 ft
1300 mm (52")	13 X 14 ft
1400 mm (56")	14 X 16 ft

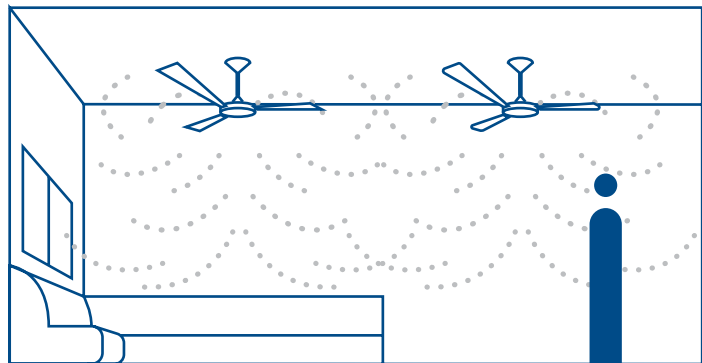

For a much more larger room, consider using two fans to balance the air circulation in all parts.

## Optimal Height

For ceilings that are taller than nine feet, add 6" to the downrod for every foot of height.

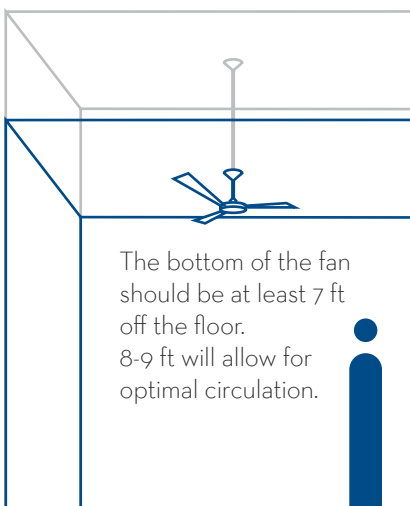

The more space between the ceiling and the blades, the better for air flow and circulation.

- 10 ft
- 9 ft
- 8 ft } Optimal height
- 7 ft
- 6 ft
- 5 ft
- 4 ft
- 3 ft
- 2 ft
- 1 ft
- 0 ft

## Energy Efficiency

Lower electricity consumption means higher savings. The more stars there are, the more your savings are.





# DECOR STORIES

Browse through our décor stories that help you select the right fan for your interiors. Complement your ceiling with a wide range of stylized designs that are available in many colours.



MINIMALIST DECOR

ECLECTIC DECOR

CONTEMPORARY DECOR

MODERN DECOR

INDUSTRIAL / RUSTIC DECOR

LUXURIOUS DECOR

ETHNIC DECOR

TRADITIONAL DECOR

SCANDINAVIAN DECOR



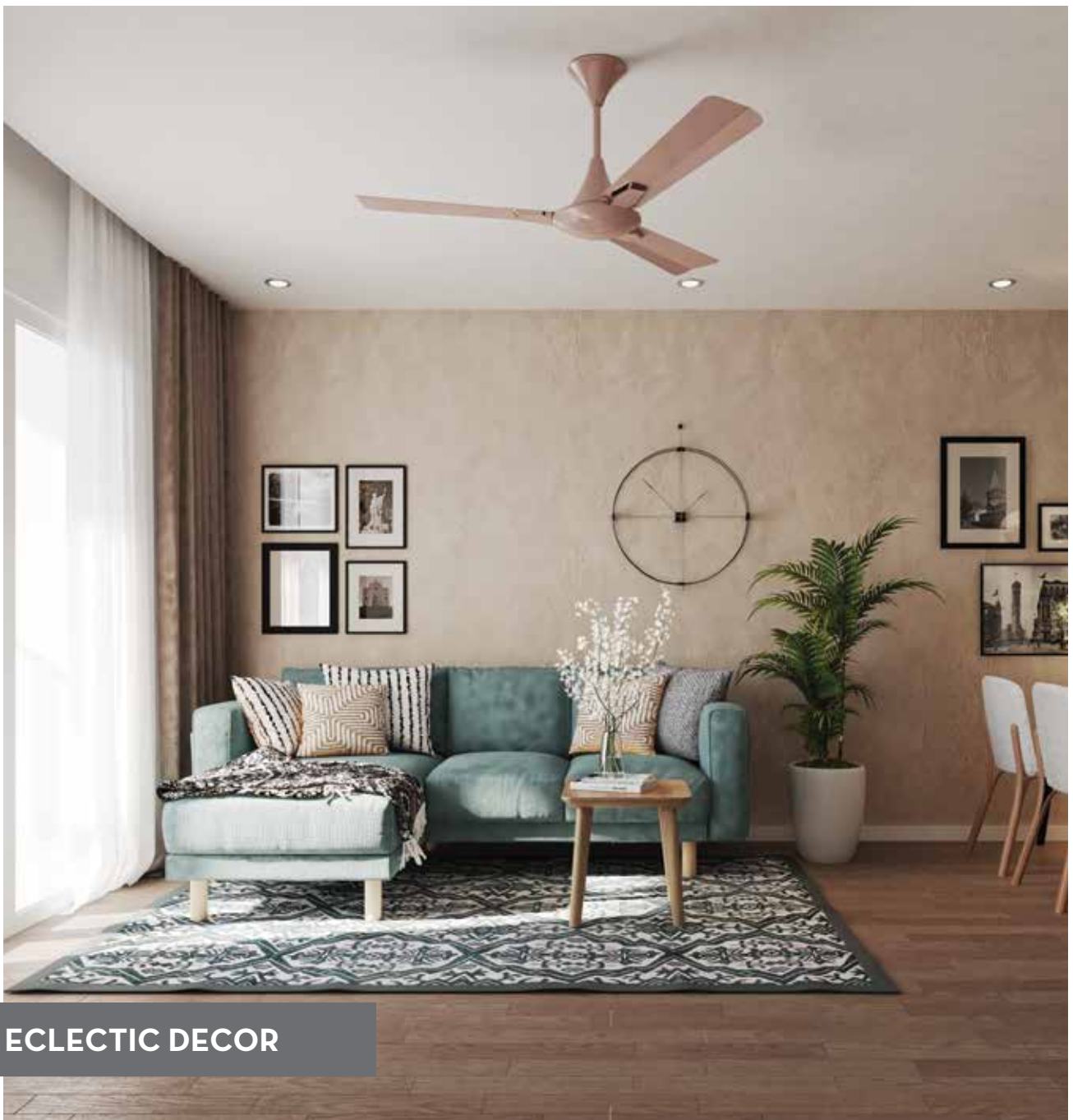

**ECLECTIC DECOR**

Mix it up! Old and new, vintage and radical, this design school is less about haphazard throwing together of pieces and more about being able to borrow specific styles, trends, colour combinations and more from across the decades come together to create a distinct, yet cohesive mood.

Featured: Aura2 Prime  
Rose Gold  
Pg no. 56

Other Recommendations:



Aura2 Design 3D Lotus  
Birken Broze pg. 51



Gianna  
Tapioca pg. 67



Aura2 Prime  
Birken Effect pg. 57



Other Recommendations:



Energy Stylus  
Gloss Black

pg. 40



Diego  
Smoked Brown

pg. 74



Aura2 Designer 2D  
Bakers Brown

pg. 53

Featured: Avancer Prime Cocoa Gold | Pg no. 60

ECLECTIC DECOR

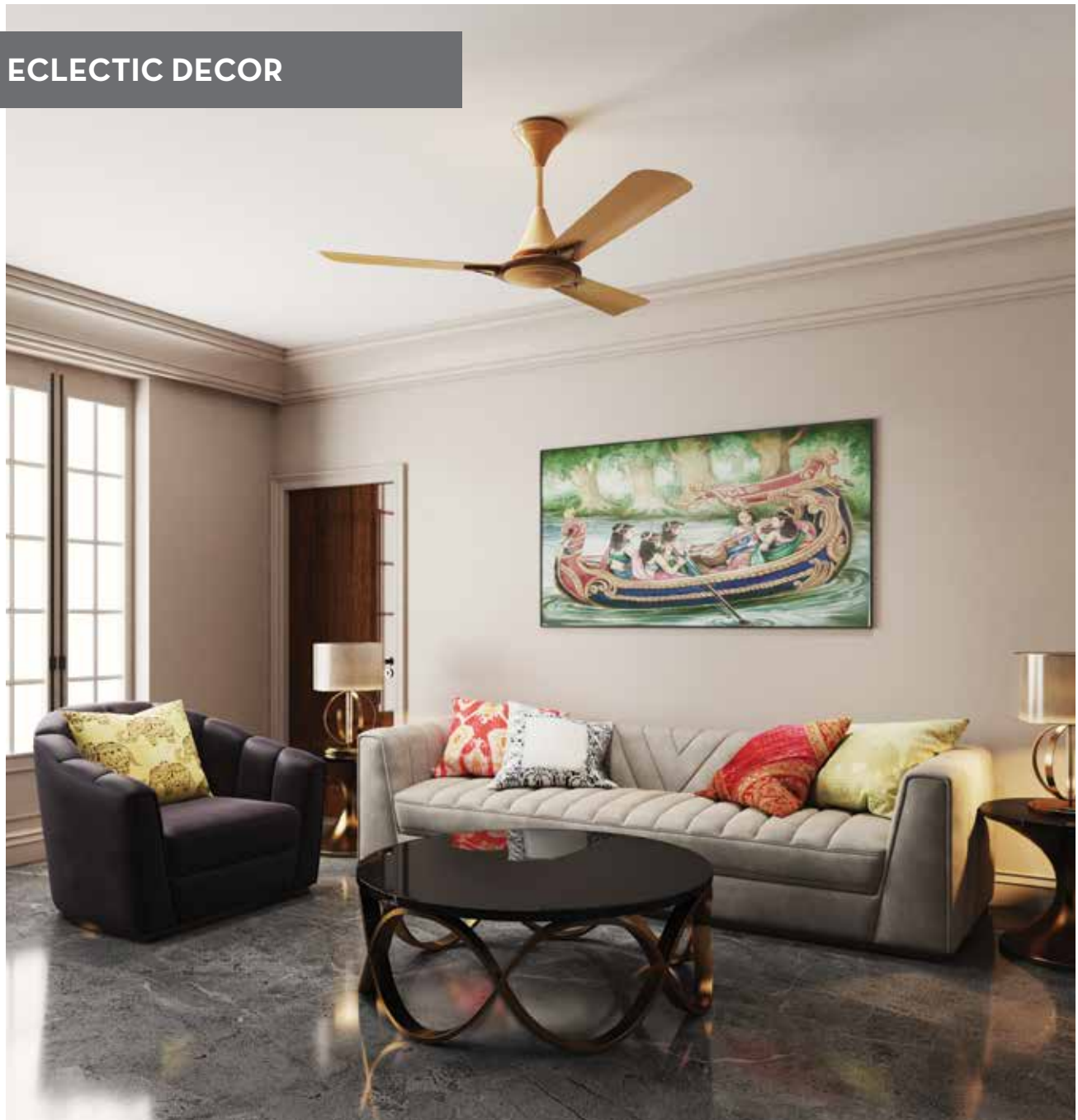



**CONTEMPORARY DECOR**

Contemporary styling is all about creating an aesthetic that's trendy, inclusive and feels like it belongs in the present. Right now, it's all about muted colour schemes, curated accessories and furniture with clean lines and soft edges. Work with natural elements, industrial accents and subtle prints to add your own distinctive warmth and charm.

Featured: Jura Prime  
Conch Cream  
Pg no. 70

Other Recommendations:



Gianna  
Roast Brown

pg. 67



Avancer Prime Antidust  
Conch Cream

pg. 61

Despite the misleading name, modern styling is rooted somewhere in the mid-20th century. Clean lines, curated pieces and a refined, unfussy approach is what it's all about. Focus on a handful of earthy tones with wood, stone or metal accents to bring it to life.

Other Recommendations:



SilentPro Blossom Matt Black

pg. 25



SilentPro Chestnut Wood

pg. 29



Jura Designer Dark Cherry Wood

pg. 63

Featured: SilentPro Silk White | Pg no. 26

MODERN DECOR





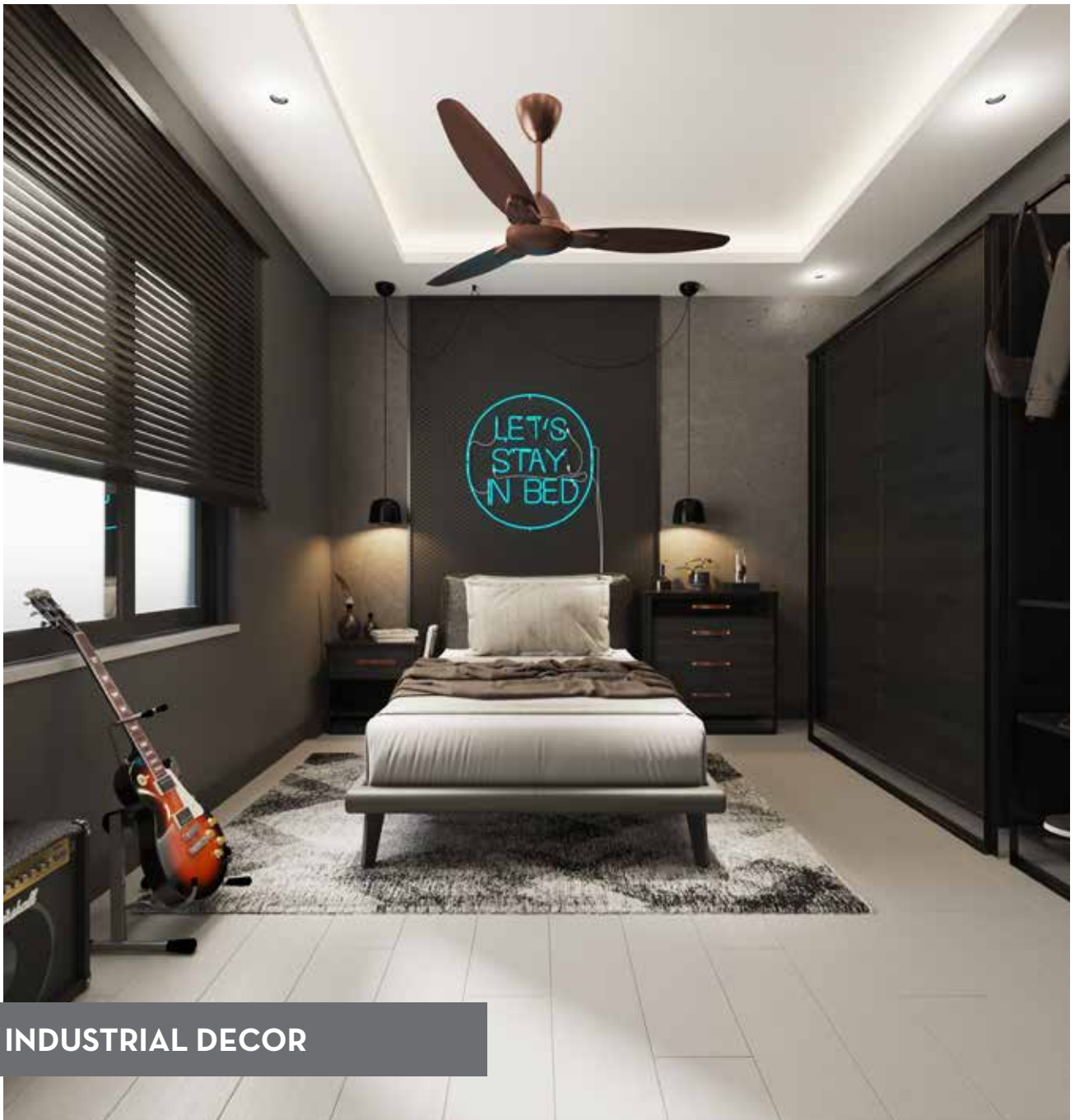

**INDUSTRIAL DECOR**

Born from the foundations of old warehouses, factories and mills, this style focuses on staying close to the raw nature of space. High ceilings, open plan formats, high-contrast art pieces, darker colour palettes and plenty of metal create a look that's polished yet ever welcoming and casual.

Featured: Senoprime  
Roast Brown  
Pg no. 69

Other Recommendations:



Gianna  
Roast Brown

pg. 67



Diego  
Matte Black

pg. 74



Aura Prime  
Onyx

pg. 59

'Champagne kisses and caviar dreams' - luxe styling is all about sophisticated self-expression, plush ornamentation and most of all - balance. Maximise comfort while adding enough interest and warmth through rich fabrics, edited accents and clean, nude palettes. There's room for everyone from the Zen-loving modernists to the whimsical maximalists to make their own style statement.

Other Recommendations:

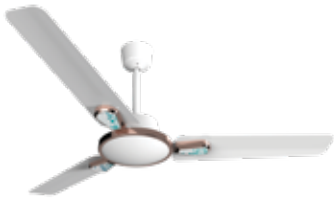

Energy Stylus  
Glow White

pg. 40



Avancer Prime  
Conch Cream

pg. 61

Featured: Aura2 Prime Antidust Pearl White Titanium | Pg no. 57

LUXURIOUS DECOR



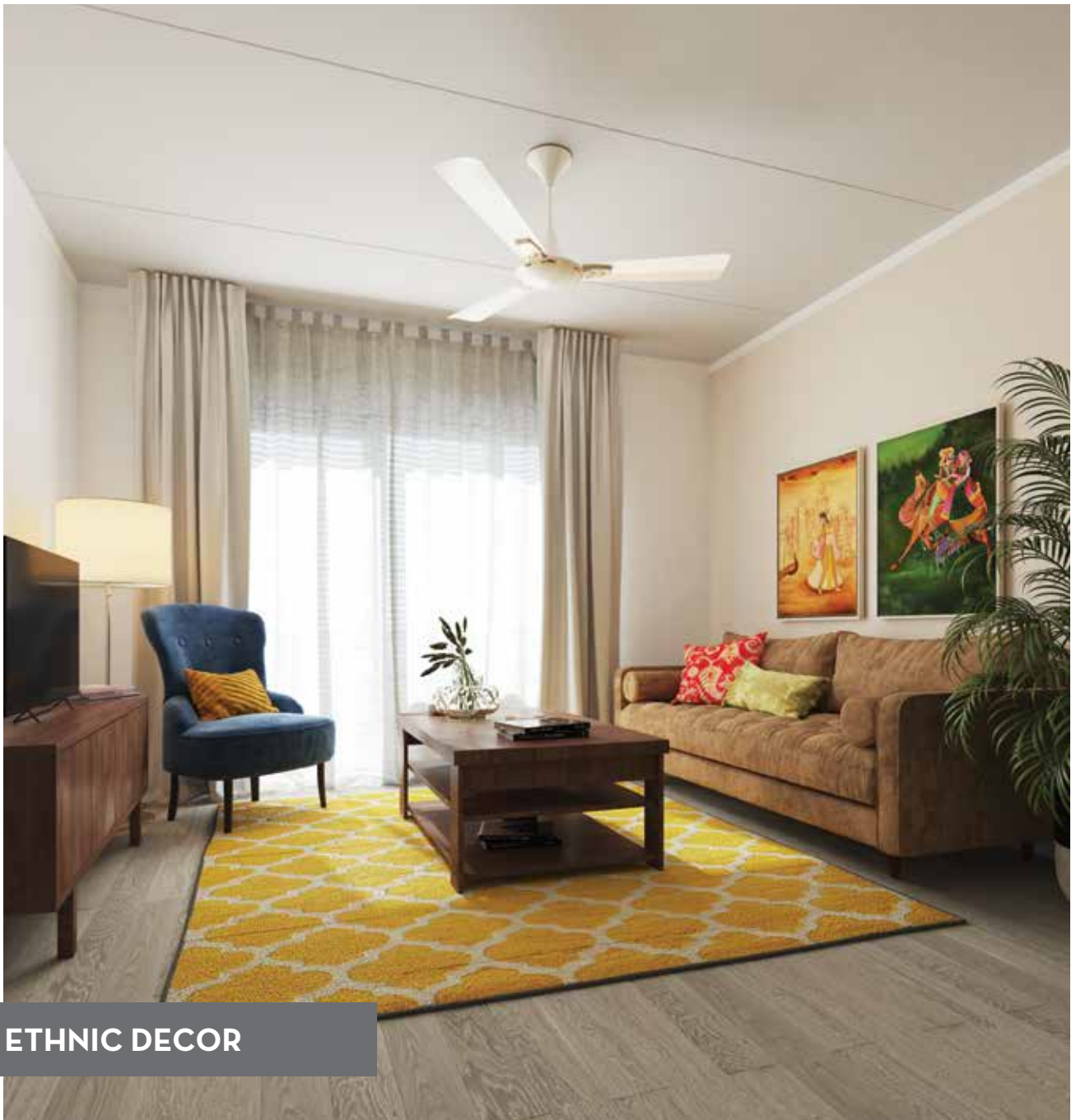

**ETHNIC DECOR**

Recreating the warmth and charm of India is easy when you start with the right foundation. Choose custom-made pieces that show off your connection to the culture and handicrafts and add motifs that bring back memories of ancestral bungalows and grandma’s colourful saris. Finally, temper it all by sticking to a handful of colours, earthy elements and plenty of natural lighting.

Featured: Aura2 Designer 3d  
 Pearl White  
 Pg no. 51

Other Recommendations:



Gianna  
 Pearl White

pg. 67



Energion Stylus  
 Toast Brown

pg. 40



Aura Prime  
 Butter Scotch

pg. 59



Scandinavia-inspired, uncluttered and stylish; minimalism embodies the idea of doing more with less. While the word might conjure up visions of monochrome rooms with sparse décor, it has evolved into multiple versions that include bohemian underpinnings, retro touches and punchy colour accents.

Other Recommendations:



Aura2 Prime  
Titanium

pg. 57



Aura2 Prime  
Pearl White

pg. 57



Jura  
Bakers Brown

pg. 70

Featured: SilentPro Charcoal Grey | Pg no. 29

MINIMALIST DECOR



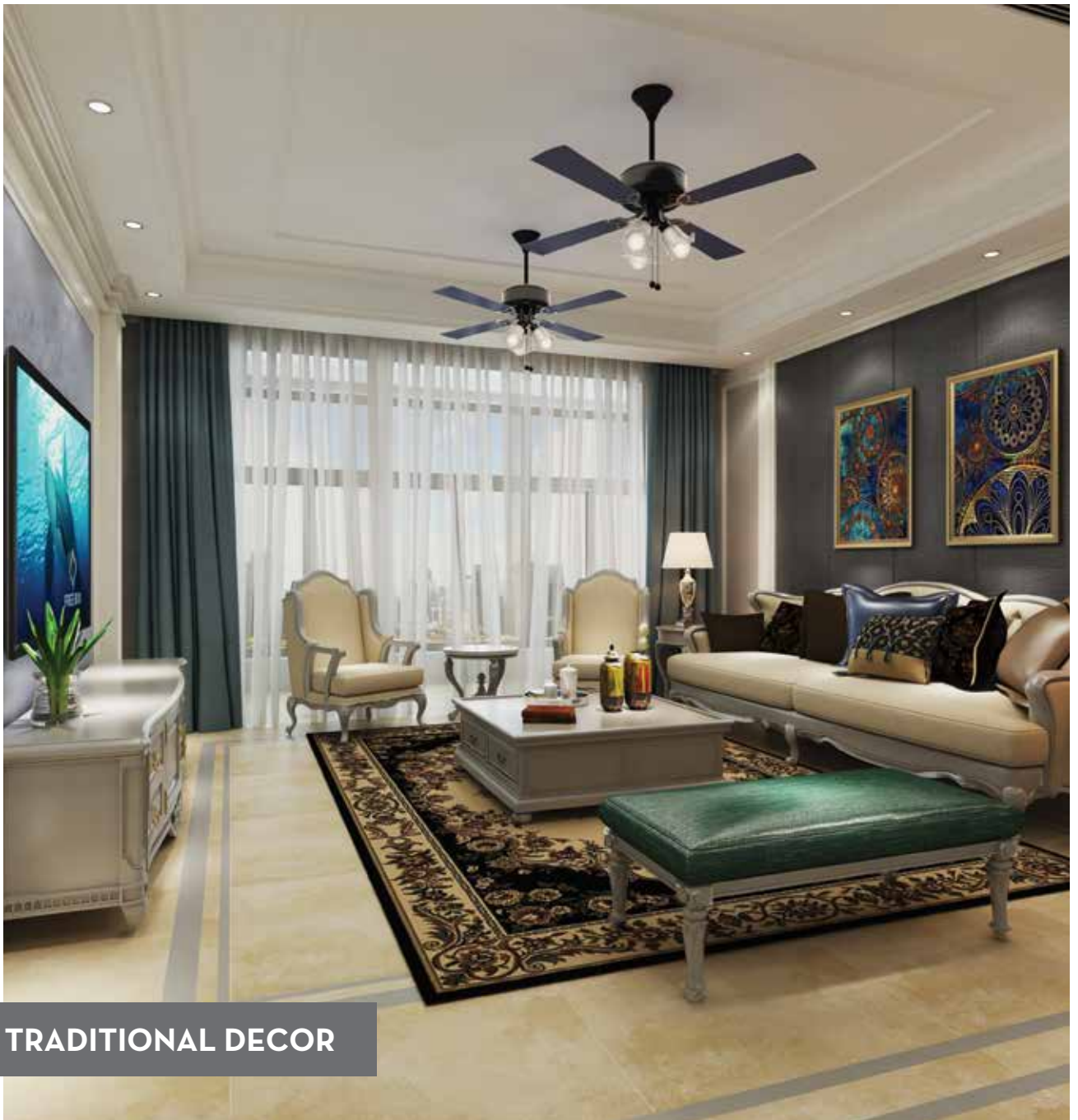

## TRADITIONAL DECOR

Keep it simple and unruffled. Everything about this décor is refined and classic. From the colour choices to the furniture choices and placement symmetry, this look is all about comfort without being crowded. There are no wild cards here, just rich details and dependable harmony.

Featured: Uranus  
Black Chrome  
Pg no. 44

Other Recommendations:



Premion Evaglow  
Wooden

pg. 62



This design style relies on finding beauty and elegance in clean, uncluttered spaces that are still distinct and evocative. Function and form, work shoulder-to-shoulder in this aesthetic which values geometric shapes, lots of texture and neutral backdrops in new and ever-evolving ways.

Other Recommendations:



SilentPro  
Silk White

pg. 26



Aura2 Prime  
Pearl White

pg. 57

Featured: Jura Designer White Marble | Pg no. 63

SCANDINAVIAN DECOR







# SILENTPRO FANS

The SilentPro range, with all new aesthetics and aerodynamic ABS body is designed to deliver Superior Air Comfort with reduced noise levels. SilentPro fans are 2X more Silent\* than regular fans and are powered by the highly Energy Efficient ActivBLDC motor.



NEW



Denin Blue

## BLOSSOM SMART



- Fluidic Design with aerodynamic ABS body
- BEE 5 Star rated fan
- 12 W LED Underlight with three modes - Warm, Natural, Cool
- Operate the fan from anywhere with mobile app
- Voice control via Alexa, OK Google
- Ceiling adjustable telescopic mounting

Room Area (sq.ft)	Sweep (mm)	Power Inputs (Watts)	Speed (RPM)	Air Delivery (CMM)
156	1200	40W	300	245

Room Type - Bedroom. Living Room.

Other Recommendations:



Glossy White



Mocha Brown

# Operate from anywhere



## Natural Breeze Mode

Activate breeze mode through mobile app to recreate the natural breeze effect, wherein the fan speed steps up from 3 to 5 and back to speed 3 step-wise every 30 seconds.

## The All New Sleep Mode

Sleep mode with a difference. By activating, the fan will reduce its speed step-wise every 90 minutes and continue to rotate at speed 1 to provide a silent and peaceful sleep through the night



## 2X MORE SILENT AT 52 dB\*\*

Decibels Noise levels in dB	10 dB	30 dB	<b>50 dB</b>	70 dB	90 dB
Reference	Normal Breathing	Soft Whisper	<b>A Quiet Home</b>	Loud Conversation	Hand Blender

## POINT ANYWHERE SMART REMOTE

No need to point at the fan to operate like ordinary remotes



- MULTI-PAIRING REMOTE FUNCTION
- INTELLIGENT MEMORY FUNCTION
- SLEEP WELL TIMER FUNCTION

## ACTIVBLDC

### HEART OF HIGH PERFORMANCE TECHNOLOGY



#### What makes Crompton ActivBLDC Superior?

- High Power Factor of 0.98 for 98% effective energy utilization#
- 90V - 300V Wide Voltage Range#
- 5 Year Warranty#

	Conventional Fan	Crompton SILENTPRO enso
Power Consumption	80 W	40 W
Hours of Usage per day	16	16
KWhr Units per day (Power X Hours / 1000)	1.28	0.64
Electricity Bill per day (₹) ₹ 6.5 / unit	8.32	4.16
Electricity Bill per annum (₹)	3,040	1,520
<b>Annual Savings on 1 Fan</b>		<b>₹ 1,520 /-</b>
<b>Annual Savings on 4 Fans</b>		<b>₹ 6,080 /-</b>

\*\*Most regular ceiling fans operate at 64 dB. Every increase of 10 dB in noise level is perceived to be twice as loud. SilentPro operates at 52 dB level thereby making it twice more silent than its conventional counterparts. \*Upto 50% Energy Saving as compared to a regular ceiling fan operating at the same RPM. # In select models only.



**NEW**



Matt Black

## BLOSSOM

-   
2X  
**SILENT**
-   
UP TO  
**50% ENERGY SAVINGS**
-   
**ACTIVBLDC**  
TECHNOLOGY
-   
**5 YEAR WARRANTY**

- Fluidic Design with aerodynamic ABS body
- BEE 5 star rated fan
- 12 W LED Underlight with three modes - Warm, Natural, Cool
- Easy to clean- Anti-dust fan
- Works with point anywhere smart remote
- Ceiling adjustable telescopic mounting

Room Area (sq.ft)	Sweep (mm)	Power Inputs (Watts)	Speed (RPM)	Air Delivery (CMM)
156	1200	40W	300	245

Room Type - Bedroom. Living Room.

Other Recommendations:



White



English Rose

NEW

Scan the fan image to bring it to life  
Here's how: [goo.gl/Lens](https://goo.gl/Lens)



Silk White



**POINT ANYWHERE SMART REMOTE**

-  MULTI-PAIRING REMOTE FUNCTION
-  INTELLIGENT MEMORY FUNCTION
-  SLEEP WELL TIMER FUNCTION



## ENSO

- Aerodynamic ABS body
- High Air Delivery
- Easy to clean - Anti-dust fan (in select models)
- 50% Savings on electricity costs
- Works with Point Anywhere Smart Remote
- Also available with IOT - Mobile App function (in select models)

Room Area (sq.ft)	Sweep (mm)	Power Inputs (Watts)	Speed (RPM)	Air Delivery (CMM)
156	1225	42	315	240

Room Type - Bedroom. Living Room.

## EXPERIENCE SILENCE AND COMFORT



**Silent, yet Powerful.**

The SilentPro Enso, with its all new aesthetics is designed to deliver high air delivery with reduced noise levels. The Aerodynamic design of the ABS body reduces the air friction, thereby increasing the number of rotations per minute and assuring high performance in silence.



**Experience Comfort.**

At an air delivery of 240 CMM, SilentPro Enso delivers air comfort that rivals the best of the conventional fans available in the market. The fluidic seamless design of the blades is modelled to ensure high air delivery - delivering comfort to you when you need it.



Colour Range



Silk White



All White



Charcoal Grey



Ballerina Pink



Mist White



Chestnut Wood





# ENERGION FANS

Introducing Crompton's range of Energy Efficient fans powered by ActivBLDC motor technology that ensures up to 50% Electricity Savings\* as compared to conventional fans.





Scan the fan image to bring it to life  
Here's how: [goo.gl/Lens](https://www.google.com/lens)



## Energion Groove Satin Sand

### ENERGION FANS

SAVE UP TO  
**₹7000\*\***  
EVERY YEAR

With Crompton's range of energy efficient fans  
On an average use of 4 fans

What makes Crompton  
ActivBLDC Superior?



High Power Factor of 0.98 for 98% effective energy utilization\*



90V - 300V  
Wide Voltage Range



5 Year Warranty\*

	Conventional Fan	ENERGION GROOVE
Power Consumption	75 W	28 W
Hours of Usage per day	16	16
Electricity Rate (KWH)	6.50	6.50
Electricity Bill (Per day per fan)	7.80	2.91
Electricity Bill per annum (₹)	2,850	1,100
<b>Annual Savings on 1 Fan</b>		<b>₹ 1,750 /-</b>
<b>Annual Savings on 4 Fans</b>		<b>₹ 7,000 /-</b>

\*Considering 16 hours of usage/day at a rate of ₹ 6.5/unit for Energion. \*\*applicable on select models only. \*\*only on Energion Groove.

**NEW**



**POINT ANYWHERE  
SMART REMOTE**

- MULTI-PAIRING  
REMOTE FUNCTION
- INTELLIGENT  
MEMORY FUNCTION
- SLEEP WELL TIMER  
FUNCTION



Shimmer Brown



**ROVERR SMART**

- Powerful motor with ActivBLDC technology consuming only 37W
- 12W Warm LED underlight with 3 dimming options to suit your mood and décor
- Fluidic telescopic design compatible with all types of ceilings
- Attracts 50% lesser dust than normal fans

Room Area (sq.ft)	Sweep (mm)	Power Inputs (Watts)	Speed (RPM)	Air Delivery (CMM)	BEE Rating
156	1200	37	360	230	

Room Type - Living Room. Bedroom.

Colour Range



Pristine White



Knight Blue

NEW



**POINT ANYWHERE  
SMART REMOTE**

-  MULTI-PAIRING  
REMOTE FUNCTION
-  INTELLIGENT  
MEMORY FUNCTION
-  SLEEP WELL TIMER  
FUNCTION



Champagne Gold

**ROVERR UNDERLIGHT**



- Powerful motor with ActivBLDC technology consuming only 37W
- 12W Warm LED underlight with 3 dimming options to suit your mood and décor
- Fluidic telescopic design compatible with all types of ceilings
- Attracts 50% lesser dust than normal fans

Room Area (sq.ft)	Sweep (mm)	Power Inputs (Watts)	Speed (RPM)	Air Delivery (CMM)	BEE Rating
156	1200	37	360	230	

Room Type - Living Room. Bedroom.

Colour Range



Pristine White



Black Matte



**NEW**



**POINT ANYWHERE SMART REMOTE**

- MULTI-PAIRING REMOTE FUNCTION
- INTELLIGENT MEMORY FUNCTION
- SLEEP WELL TIMER FUNCTION



Black Matte

**ROVERR NON UNDERLIGHT**



- Powerful motor with ActivBLDC technology consuming only 37W
- 12W warm LED underlight with 3 dimming options to suit your mood and décor
- Fluidic telescopic design compatible with all types of ceilings
- Attracts 50% lesser dust than normal fans

Room Area (sq.ft)	Sweep (mm)	Power Inputs (Watts)	Speed (RPM)	Air Delivery (CMM)	BEE Rating
156	1200	37	360	230	

Room Type - Living Room. Bedroom.

Colour Range



Pristine White



Champagne Gold



**POINT ANYWHERE SMART REMOTE**

- MULTI-PAIRING REMOTE FUNCTION
- INTELLIGENT MEMORY FUNCTION
- SLEEP WELL TIMER FUNCTION



Coffee brown



## GROOVE

- BEE 5 STAR Rated fan
- 50% Savings on electricity costs
- Point Anywhere Smart Remote
- Also available in version compatible with home wall regulator
- Best in class air delivery
- Anti Dust - In select models only

Room Area (sq.ft)	Sweep (mm)	Power Inputs (Watts)	Speed (RPM)	Air Delivery (CMM)	BEE Rating
156	1200	28	360	220	

Room Type - Living Room. Bedroom.

### Colour Range



Ivory



White

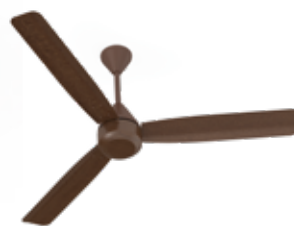

Smoked Walnut



Honey Pine



Brown



Onyx (Matte)



Satin Sand



Riviera White





**POINT ANYWHERE SMART REMOTE**

-  MULTI-PAIRING REMOTE FUNCTION
-  INTELLIGENT MEMORY FUNCTION
-  SLEEP WELL TIMER FUNCTION



## RIVIERA

- BEE 5 STAR Rated fan
- 50% Savings on electricity costs
- Point Anywhere Smart Remote
- Also available in version compatible with home wall regulator

Room Area (sq.ft)	Sweep (mm)	Power Inputs (Watts)	Speed (RPM)	Air Delivery (CMM)	BEE Rating
224	1400	36	280	275	
156	1200	32	360	220	

Room Type - Living Room. Bedroom.

### Colour Range



Riviera Brown



Riviera Ivory



Light Pine Wood



**POINT ANYWHERE  
SMART REMOTE**

-  MULTI-PAIRING  
REMOTE FUNCTION
-  INTELLIGENT  
MEMORY FUNCTION
-  SLEEP WELL TIMER  
FUNCTION

**HS**

- BEE 5 STAR Rated fan
- 50% Savings on electricity costs
- Point Anywhere Smart Remote



Room Area (sq.ft)	Sweep (mm)	Power Inputs (Watts)	Speed (RPM)	Air Delivery (CMM)	BEE Rating
156	1200	35	370	220	

Room Type - Living Room. Bedroom.

Colour Range





Mushroom Grey



**POINT ANYWHERE SMART REMOTE**

- MULTI-PAIRING REMOTE FUNCTION
- INTELLIGENT MEMORY FUNCTION
- SLEEP WELL TIMER FUNCTION



**STYLUS SMART**

- BEE 5 star rated fan
- 50% savings on Electricity cost
- Operate from anywhere with mobile app
- Voice control via Alexa, Ok Google

ANTI DUST    UP TO 50% ENERGY SAVINGS    ACTIVBLDC TECHNOLOGY    5 YEAR WARRANTY

Room Area (sq.ft)	Sweep (mm)	Power Inputs (Watts)	Speed (RPM)	Air Delivery (CMM)	BEE Rating
156	1200	35	370	220	

Room Type - Living Room. Bedroom.

Colour Range



Majolica Blue



Gloss Black



**POINT ANYWHERE  
SMART REMOTE**

-  MULTI-PAIRING  
REMOTE FUNCTION
-  INTELLIGENT  
MEMORY FUNCTION
-  SLEEP WELL TIMER  
FUNCTION

## STYLUS



- BEE 5 STAR Rated fan
- 50% Savings on electricity costs
- Easy to clean - Anti-dust fan
- Point Anywhere Smart Remote

Room Area (sq.ft)	Sweep (mm)	Power Inputs (Watts)	Speed (RPM)	Air Delivery (CMM)	BEE Rating
156	1200	35	370	220	

Room Type - Living Room. Bedroom.

### Colour Range



Toast Brown



Gloss White





BROWN



## CHARGE

- BEE 5 STAR Rated fan
- 50% Savings on electricity costs
- Compatible with home wall regulator

Room Area (sq.ft)	Sweep (mm)	Power Inputs (Watts)	Speed (RPM)	Air Delivery (CMM)	BEE Rating
156	1200	34	350	210	

Room Type - Living Room. Bedroom.

### Colour Range



Opal White



Ivory



# LUXIAN FANS

Crompton's Lifestyle range of fans with Royal décor with Underlight options that offer opulent comfort





Black Chrome

## URANUS

- Magnificent carvings for a royal décor.
- Decorative lampshades to enhance beauty.
- Convenient pull cord for speed and light control.

Room Area (sq.ft)	Sweep (mm)	Power Inputs (Watts)	Speed (RPM)	Air Delivery (CMM)
156	1200	72	320	200

Room Type - Living Room. Bedroom.

Colour Range



Ivory



Brass

## JUPITER

- Magnificent carvings for a royal décor.
- Decorative lampshades to enhance beauty.
- Convenient pull cord for speed and light control.

Room Area (sq.ft)	Sweep (mm)	Power Inputs (Watts)	Speed (RPM)	Air Delivery (CMM)
156	1200	75	300	210

Room Type - Living Room. Bedroom.



Antique Brass

## NEBULA

- Magnificent carvings for a royal décor.
- Decorative lampshades to enhance beauty.
- Convenient pull cord for speed and light control.

Room Area (sq.ft)	Sweep (mm)	Power Inputs (Watts)	Speed (RPM)	Air Delivery (CMM)
156	1200	72	320	200

Room Type - Living Room. Bedroom.





Antique Brass

## TRITON ELECTROPLATED

- Contemporary design to complement modern décor
- Electroplated finish for superior aesthetics.
- Aerodynamically designed blades for high speed and air delivery.

Room Area (sq.ft)	Sweep (mm)	Power Inputs (Watts)	Speed (RPM)	Air Delivery (CMM)
156	1200	70	350	210

Room Type - Living Room. Bedroom.

### Colour Range



Brushed Steel



Antique Copper





# PREMIUM FANS

Spruce up your interiors with  
Crompton's Premium & Designer  
range of fans





## AURA2

Aura2 comes with a 5 year warranty powered by Duratech technology. Duratech uses premium components, designed to deliver a superlative performance over the years.

Here's a quick look at the key components that form the core of the Duratech technology.

Duratech comprises of:



### High Endurance Box Capacitor

Aura's high-endurance box capacitor, with a patented adapter, ensures superior performance over a longer period as compared to ordinary oil-filled tube-type capacitors.



### Dual Coat Copper

Dual-coat copper, used in motor windings, offers double protection, ensuring better insulation and abrasion resistance when subjected to high temperatures and sudden overloads. This results in longer durability as compared to ordinary copper wire.



### High Grade EMQ Bearing

EMQ bearings used for the Aura motor are the highest-grade bearings available for fans. They are silent and smooth, and have the additional advantage of reduced friction and vibration.



### High Standard Hybrid Steel

Aura fans use hybrid steel which is highly compatible with electric motors. The composition and the thickness of the steel ensures fan durability and efficiency.



Birken Effect

PREMIUM

Lotus Design

## AURA2 DESIGNER 3D

- Elegant design to compliment modern décor
- Broad blade design for Higher Air Delivery
- High Speed



Room Area (sq.ft)	Sweep (mm)	Power Inputs (Watts)	Speed (RPM)	Air Delivery (CMM)
156	1200	74	380	230

Room Type - Living Room. Bedroom.

### Colour Range



Pearl White



Oakwood

## AURA2 DESIGNER WOODEN



- Elegant design to compliment modern décor
- Broad blade design for Higher Air Delivery
- High Speed

Room Area (sq.ft)	Sweep (mm)	Power Inputs (Watts)	Speed (RPM)	Air Delivery (CMM)
156	1200	74	380	230

Room Type - Living Room. Bedroom.

### Colour Range



Pearl Ivory Wood





Bakers Brown

Brocade Design

## AURA2 DESIGNER 2D

- Elegant design to compliment modern décor
- Broad blade design for Higher Air Delivery
- High Speed



Room Area (sq.ft)	Sweep (mm)	Power Inputs (Watts)	Speed (RPM)	Air Delivery (CMM)
156	1200	74	380	230

Room Type - Living Room, Bedroom.

### Colour Range



Birken Effect



Rose Gold



Satin Sand

Mosaic Design

## AURA2 DESIGNER 2D

- Elegant design to compliment modern décor
- Broad blade design for Higher Air Delivery
- High Speed



Room Area (sq.ft)	Sweep (mm)	Power Inputs (Watts)	Speed (RPM)	Air Delivery (CMM)
156	1200	74	380	230

Room Type - Living Room. Bedroom.



Pearl White

PREMIUM

Arab Design

## AURA2 DESIGNER 2D



- Elegant design to compliment modern décor
- Broad blade design for Higher Air Delivery
- High Speed

Room Area (sq.ft)	Sweep (mm)	Power Inputs (Watts)	Speed (RPM)	Air Delivery (CMM)
156	1200	74	380	230

Room Type - Living Room. Bedroom.

### Colour Range



Titanium



Rose Gold

## AURA2 PRIME



- Elegant design to compliment modern décor
- Broad blade design for Higher Air Delivery
- High Speed
- Available in 600mm, 900mm - in select colours only

Room Area (sq.ft)	Sweep (mm)	Power Inputs (Watts)	Speed (RPM)	Air Delivery (CMM)
156	1200	74	380	230

Room Type - Living Room. Bedroom.

Colour Range



Irish Coffee



Titanium



Pearl White Titanium



Pearl White



Birken Effect



Bakers Brown

PREMION



Titanium Effect

## AURA PRIME



- Contemporary design with decorative trims
- Broad blade design for Higher Air Delivery
- High Speed

Room Area (sq.ft)	Sweep (mm)	Power Inputs (Watts)	Speed (RPM)	Air Delivery (CMM)
50	600	65	875	120
70	900	62	410	155
100	1050	65	360	190
156	1200	74	380	230
224	1400	84	285	270

Room Type - Powder Room. Kitchen. Bedroom. Living Room.



# INDIA'S FIRST ANTI-DUST FAN

Colour Range



Birken Effect



Husky Gold



Butter Scotch



Onyx



Chicory



Lagoon Blue



Dusky Brown



Lilac Matt



Himalayan Grey



Lilac Gloss

PREMION

\* 600 mm, 900 mm and 1050 mm sweeps are available in Birken Effect, Onyx and Chicory.



Cocoa Gold

## AVANCER PRIME



- Unique angular motor design to spruce up your interiors.
- Broad blade design for Higher Air Delivery
- High Speed

Room Area (sq.ft)	Sweep (mm)	Power Inputs (Watts)	Speed (RPM)	Air Delivery (CMM)
70	900	56	420	155
100	1050	68	390	195
156	1200	77	370	230
224	1400	84	285	270

Room Type - Kitchen. Bedroom. Living Room.

# INDIA'S FIRST ANTI-DUST FAN

Colour Range



Conch Cream



Lilac Matt



Bakers Brown



Roast Brown



Coffee Brown



Silky Silver



Indigo Blue



Lagoon Blue



Berry Blast



Charcoal grey

PREMION

\*900 and 1400 sweeps are available only in Cocoa Gold, Bakers Brown and Conch Cream

\*1050 sweep available only in Cocoa Gold and Conch Cream



Cappuccino Brown



## EVAGLOW

- Rich and stunning finish
- Powerful motor for high air thrust and delivery
- Remote control
- 6W LED Underlight - Warm White with dimming option
- Easy to clean - Anti-dust fan (in select colours only)

Room Area (sq.ft)	Sweep (mm)	Power Inputs (Watts)	Speed (RPM)	Air Delivery (CMM)
156	1200	56W	350	215

Room Type - Living Room. Bedroom.

### Colour Range



Champagne Gold



White



Ivory



Wooden



Dark Cherry Wood

PREMIUM

## JURA DESIGNER



- Unmatched beauty of wooden finish
- Wider blades for higher air delivery
- High Speed

Room Area (sq.ft)	Sweep (mm)	Power Inputs (Watts)	Speed (RPM)	Air Delivery (CMM)
156	1200	74	380	230

Room Type - Living Room. Bedroom.

Colour Range

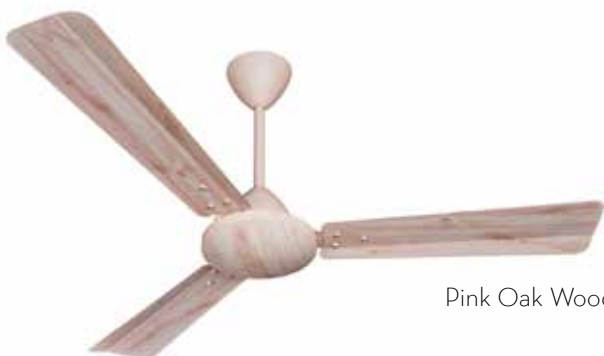

Pink Oak Wood





# HIGHSPEED FANS

Elegant designs to enhance your décor, offering superior air delivery for maximum comfort





NEW



Husky Gold Bronze



## VERSA

- Decorative motor design
- Wider blades for higher air delivery

Room Area (sq.ft)	Sweep (mm)	Power Inputs (Watts)	Speed (RPM)	Air Delivery (CMM)
156	1200	67	380	210

Room Type - Living Room. Bedroom.

### Colour Range



Tawny Brown



Pearl White



Midnight Grey



Roast Brown

HIGHSPEED



## GIANNA

- Decorative motor design
- Metallic finish with Anti-corrosive blade & body
- Wider blades for higher air delivery
- Also Available in 600mm, 900mm

Room Area (sq.ft)	Sweep (mm)	Power Inputs (Watts)	Speed (RPM)	Air Delivery (CMM)
156	1200	75	380	220

Room Type - Living Room. Bedroom.

### Colour Range



Pearl White

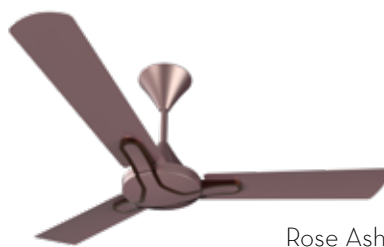

Rose Ash

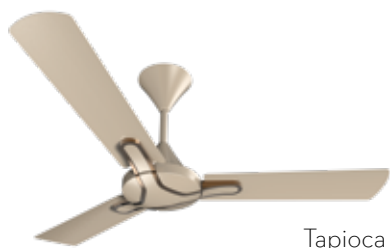

Tapioca



Walnut Brown



Ivory



## AURA

- Contemporary design to compliment modern décor
- Broad and aerodynamically designed blades for high air delivery
- 600, 900, 1400 sweeps are available only in Ivory

Room Area (sq.ft)	Sweep (mm)	Power Inputs (Watts)	Speed (RPM)	Air Delivery (CMM)
50	600	65	875	120
70	900	62	410	155
156	1200	74	380	230
224	1400	84	285	270

Room Type - Powder Room. Kitchen. Bedroom. Living Room.

### Colour Range



New White



Brown



Cool Grey



HIGHSPEED

## SENOPRIME

- Aesthetically superior deco trims
- Innovative designer fan blade

Room Area (sq.ft)	Sweep (mm)	Power Inputs (Watts)	Speed (RPM)	Air Delivery (CMM)
70	900	60	420	160
156	1200	75	370	225

Room Type - Kitchen. Living Room. Bedroom.

### Colour Range



Olive Green



Maroon Matt

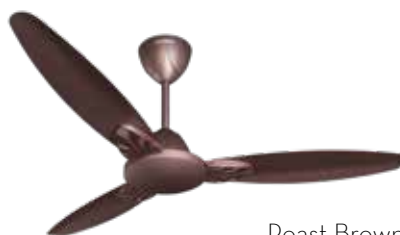

Roast Brown



Opal White



## SENORITA

- Unique petal shaped blades to enhance aesthetics
- Attractive trims to complement modern décor

Room Area (sq.ft)	Sweep (mm)	Power Inputs (Watts)	Speed (RPM)	Air Delivery (CMM)
70	900	60	420	160
156	1200	75	370	225

Room Type - Kitchen. Living Room. Bedroom.



Conch Cream

Colour Range



Bakers Brown



## JURA PRIME

- Simple, yet elegant fan with Anti-dust properties
- Preferred choice of Interior designers
- Matt satin finish
- 600, 900 and 1050 mm available in Conch Cream

Room Area (sq.ft)	Sweep (mm)	Power Inputs (Watts)	Speed (RPM)	Air Delivery (CMM)
156	1200	74	380	230

Room Type - Living Room. Bedroom.



Colour Range

Pearl Ivory

Pearl Silver White



## JURA

- Simple, yet elegant fan
- Preferred choice of Interior designers
- 600, 900 and 1050 mm sweeps are available only in Pearl Silver White

Room Area (sq.ft)	Sweep (mm)	Power Inputs (Watts)	Speed (RPM)	Air Delivery (CMM)
50	600	65	875	120
70	900	62	410	155
100	1050	65	360	190
156	1200	74	380	230
224	1400	84	285	270

Room Type - Powder Room. Kitchen. Bedroom. Living Room.

HIGHSPEED



Colour Range

Ash Blue

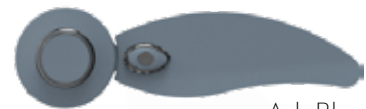

Roast Brown



Coral Gold

## DEVINE

- Decorative motor and designer blades to complement modern décor
- Unique petal shaped blades to enhance aesthetics

Room Area (sq.ft)	Sweep (mm)	Power Inputs (Watts)	Speed (RPM)	Air Delivery (CMM)
156	1200	76	370	225

Room Type - Living Room. Bedroom.





Pearl White



## MODERN LEAF

- Unique motor design with dual tone trims
- Metallic finish with Anti-corrosive blade & body
- Wider blades for higher air delivery

Room Area (sq.ft)	Sweep (mm)	Power Inputs (Watts)	Speed (RPM)	Air Delivery (CMM)
156	1200	72	390	220

Room Type - Living Room. Bedroom.

### Colour Range



Smoked Brown



Satin Sand



Pastel Grape





Ash Blue



HIGHSPEED

## RUBIO

- An aesthetic design with contemporary finish to give a modern appeal
- Motor design with deco ring with designer trims

Room Area (sq.ft)	Sweep (mm)	Power Inputs (Watts)	Speed (RPM)	Air Delivery (CMM)
156	1200	72	380	230

Room Type - Living Room. Bedroom.

### Colour Range



Glow White



Red Wine



Warm Grey



Smoked Brown



## DIEGO

- Anti-corrosive blade & body
- Wider blades for higher air delivery
- Also available in 600mm & 900mm

Room Area (sq.ft)	Sweep (mm)	Power Inputs (Watts)	Speed (RPM)	Air Delivery (CMM)
156	1200	72	380	210

Room Type - Living Room. Bedroom.

Colour Range



Opal White



Ivory



Matte Black



Ginger Gold

Colour Range



Bakers Brown



Aqua Gold



Lavender



## HS DECORA METALLIC

- Aerodynamically designed blades for high speed and air delivery
- Superior metallic colour options to enhance décor
- Gold ring on canopies

Room Area (sq.ft)	Sweep (mm)	Power Inputs (Watts)	Speed (RPM)	Air Delivery (CMM)
156	1200	70	370	230

Room Type - Living Room. Bedroom.

HIGHSPEED



Brown

Colour Range



Ivory



## HS DECORA

- Ornamental design with gold finish shanks on motor & blades
- Gold ring on canopies

Room Area (sq.ft)	Sweep (mm)	Power Inputs (Watts)	Speed (RPM)	Air Delivery (CMM)
156	1200	70	370	230
224	1400	80	280	270

Room Type - Living Room. Bedroom.



Opal White



## HS PLUS

- BEE Star rated fan
- Power saving fan
- National Energy Conservation Award for Energy efficient fan from BEE

Room Area (sq.ft)	Sweep (mm)	Power Inputs (Watts)	Speed (RPM)	Air Delivery (CMM)
156	1200	53	370	218

Room Type - Living Room. Bedroom.

### Colour Range



Brown



Ivory



Brown



HIGHSPEED

## HS

- Unique gold line on motor
- 600, 900, 1050, 1400 mm sweeps are available only in Opal White, Brown and Ivory.

Room Area (sq.ft)	Sweep (mm)	Power Inputs (Watts)	Speed (RPM)	Air Delivery (CMM)
50	600	64	900	120
70	900	60	390	155
100	1050	66	370	195
156	1200	70	370	230
224	1400	80	280	270

Room Type - Powder Room. Kitchen. Bedroom. Living Room.

### Colour Range



Ivory



Opal White



Bianco



## RIVIERA

- Simplicity in motor design
- Standard model with good performance
- Bianco colour available in 1200 sweep only
- Also available in Opal White

Room Area (sq.ft)	Sweep (mm)	Power Inputs (Watts)	Speed (RPM)	Air Delivery (CMM)
70	900	60	390	155
100	1050	66	370	195
156	1200	72	400	220
224	1400	85	270	260

Room Type - Kitchen. Bedroom. Living Room.

Colour Range



Brown

NEW

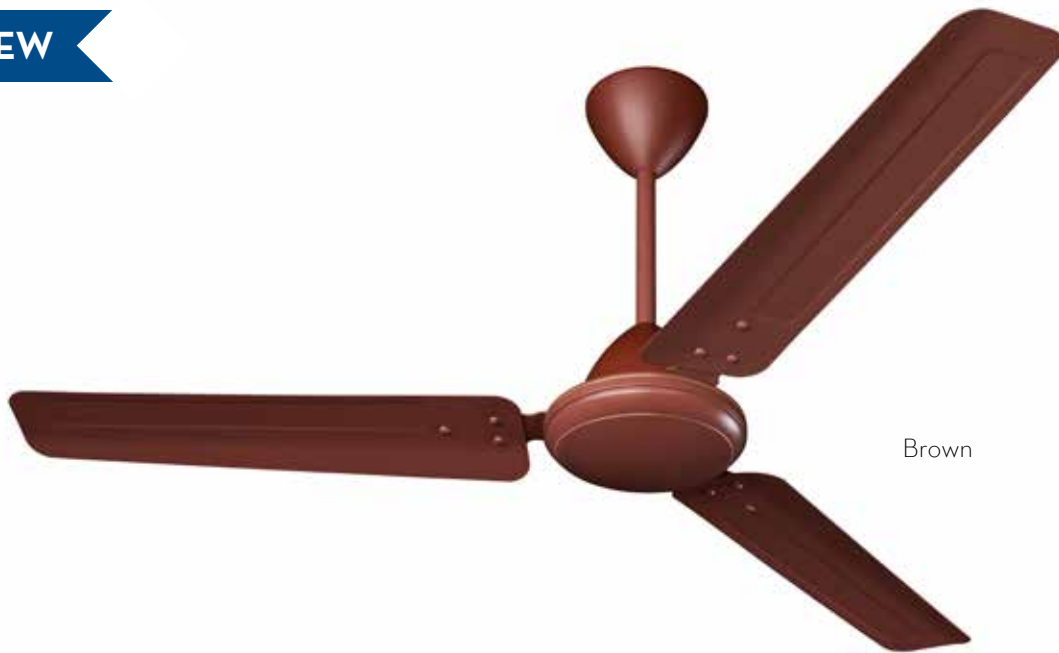

Brown



HIGHSPEED

## DASHER 425

- Highspeed 425 rpm
- Simplicity in motor design.

Room Area (sq.ft)	Sweep (mm)	Power Inputs (Watts)	Speed (RPM)	Air Delivery (CMM)
156	1200	72	425	210

Room Type - Powder Room. Kitchen. Bedroom. Living Room.

### Colour Range



White



Ivory





# SUREBREEZE FANS

Superior performance with double  
ball bearing



NEW



Smoked Brown



## MONTANIA

- Decorative trims on motor and blade

Room Area (sq.ft)	Sweep (mm)	Power Inputs (Watts)	Speed (RPM)	Air Delivery (CMM)
156	1200	66	380	210

Room Type - Living Room. Bedroom.

Colour Range

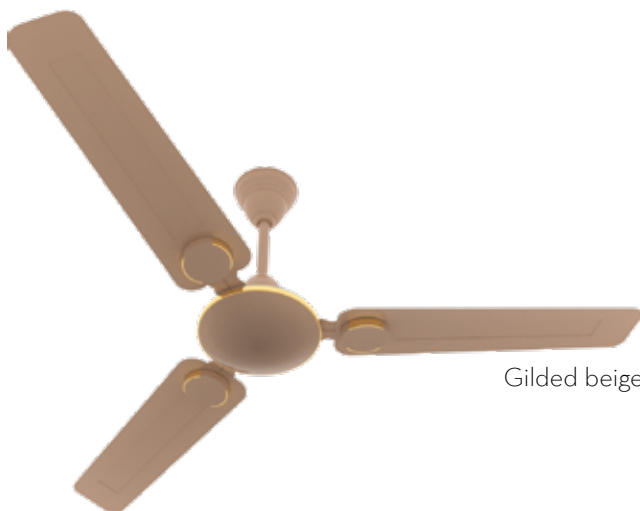

Gilded beige



White



Smoked Brown

Colour Range



Birken Ivory



Silver White



Birken White



## SUPER BRIZ DECO

- Decorative trims on motors and blades
- Silver White available only in 1200 mm sweep

Room Area (sq.ft)	Sweep (mm)	Power Inputs (Watts)	Speed (RPM)	Air Delivery (CMM)
70	900	60	420	140
156	1200	70	400	210
224	1400	80	300	245

Room Type - Kitchen. Bedroom. Living Room.

SUREBREEZE



Smoked Brown

Also Available in Birken Ivory, Silver White & Birken White



## SUPER AIR DECO

- Decorative trims on motors and blades

Room Area (sq.ft)	Sweep (mm)	Power Inputs (Watts)	Speed (RPM)	Air Delivery (CMM)
156	1200	70	400	210

Room Type - Living Room. Bedroom.



## ARIYA BRIZ PRIME



- Unique colour options with metallic finish
- Anti-rust aluminium body and blade
- Also available in 600 mm

Room Area (sq.ft)	Sweep (mm)	Power Inputs (Watts)	Speed (RPM)	Air Delivery (CMM)
156	1200	70	370	200

Room Type - Living Room. Bedroom.



## ARIYA BRIZ



- Attractive gold ring on motor
- Anti-rust aluminium body and blade

Room Area (sq.ft)	Sweep (mm)	Power Inputs (Watts)	Speed (RPM)	Air Delivery (CMM)
50	600	64	850	120
156	1200	68	380	210

Room Type - Powder Room. Living Room. Bedroom.



Colour Range



Lustre Brown



## COOL BREEZE

- Attractive gold ring on motor
- Anti-rust aluminium body and blade
- 900 mm sweep is available only in opal white
- 1400 mm sweep is available only in opal white

Room Area (sq.ft)	Sweep (mm)	Power Inputs (Watts)	Speed (RPM)	Air Delivery (CMM)
50	600	55	860	110
70	900	65	460	135
100	1050	70	420	165
156	1200	75	380	210
224	1400	82	290	245

Room Type - Powder Room. Kitchen. Bedroom. Living Room.

SUREBREEZE



Colour Range



Brown



## BRIZ AIR

- Anti-rust aluminium body and blade
- 1400 mm sweep is available only in Opal White

Room Area (sq.ft)	Sweep (mm)	Power Inputs (Watts)	Speed (RPM)	Air Delivery (CMM)
50	600	62	850	115
70	900	60	415	145
100	1050	68	370	180
156	1200	75	380	205
224	1400	75	290	245

Room Type - Powder Room. Kitchen. Bedroom. Living Room.



Colour Range



Ivory

Opal White

Lustre Brown



## SEA WIND

- Attractive gold ring on motor

Room Area (sq.ft)	Sweep (mm)	Power Inputs (Watts)	Speed (RPM)	Air Delivery (CMM)
156	1200	70	380	200

Room Type - Living Room. Bedroom.



Colour Range



Ivory

Opal White

Lustre Brown



## SEA BREEZE

- Attractive gold ring on motor

Room Area (sq.ft)	Sweep (mm)	Power Inputs (Watts)	Speed (RPM)	Air Delivery (CMM)
156	1200	70	380	200

Room Type - Living Room. Bedroom.





Brown

Colour Range



Opal White

## ALPHA BRIZ

- Attractive gold ring on motor
- Also available in Ivory.



Room Area (sq.ft)	Sweep (mm)	Power Inputs (Watts)	Speed (RPM)	Air Delivery (CMM)
156	1200	75	380	205

Room Type - Living Room. Bedroom.

SUREBREEZE



Brown

Colour Range



Ivory



Opal White

## NEO BREEZE

- Attractive gold ring on motor



Room Area (sq.ft)	Sweep (mm)	Power Inputs (Watts)	Speed (RPM)	Air Delivery (CMM)
156	1200	75	380	205

Room Type - Living Room. Bedroom.



Brown

Colour Range

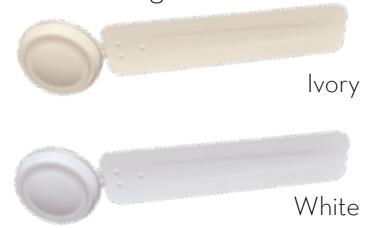

Ivory

White



## GALLOP

- Attractive gold ring on motor

Room Area (sq.ft)	Sweep (mm)	Power Inputs (Watts)	Speed (RPM)	Air Delivery (CMM)
156	1200	76	380	210

Room Type - Living Room. Bedroom.



Winzer Brown

Colour Range



Ivory

White



## WINZER

- Attractive gold ring on motor

Room Area (sq.ft)	Sweep (mm)	Power Inputs (Watts)	Speed (RPM)	Air Delivery (CMM)
156	1200	65	380	200

Room Type - Living Room. Bedroom.



Opal White



## SEA BLISS

- Attractive gold ring on motor
- High Speed of 400 RPM
- Also available in Brown & Ivory

Room Area (sq.ft)	Sweep (mm)	Power Inputs (Watts)	Speed (RPM)	Air Delivery (CMM)
156	1200	65	400	200

Room Type - Living Room. Bedroom.



Opal White



## STAR 220

- BEE Star rated fan
- National Energy Conservation Award for Energy efficient fan from BEE

Room Area (sq.ft)	Sweep (mm)	Power Inputs (Watts)	Speed (RPM)	Air Delivery (CMM)
156	1200	50	360	220

Room Type - Living Room. Bedroom.



Opal White



## ENTRUST 50

- BEE Star rated fan
- National Energy Conservation Award for Energy efficient fan from BEE

Room Area (sq.ft)	Sweep (mm)	Power Inputs (Watts)	Speed (RPM)	Air Delivery (CMM)
156	1200	50	370	215

Room Type - Living Room. Bedroom.



Opal White



## EMPOWER 50

- BEE Star rated fan
- National Energy Conservation Award for Energy efficient fan from BEE

Room Area (sq.ft)	Sweep (mm)	Power Inputs (Watts)	Speed (RPM)	Air Delivery (CMM)
156	1200	50	370	210

Room Type - Living Room. Bedroom.



Lustr Brown

Colour Range

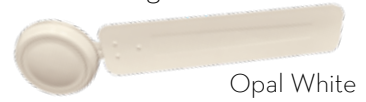

Opal White

## WWPS



- Energy saving fan

Room Area (sq.ft)	Sweep (mm)	Power Inputs (Watts)	Speed (RPM)	Air Delivery (CMM)
156	1200	50	310	200

Room Type - Living Room. Bedroom.

SUREBREEZE



Lustr Brown

Colour Range

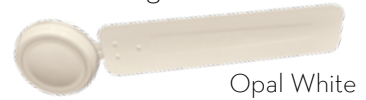

Opal White

## WWHE



- Energy saving fan

Room Area (sq.ft)	Sweep (mm)	Power Inputs (Watts)	Speed (RPM)	Air Delivery (CMM)
156	1200	50	310	200
224	1400	60	290	245

Room Type - Living Room. Bedroom.





# TABLE PEDESTAL WALL FANS

Sleek and Sturdy designs with Superior Air delivery delivering maximum comfort to you when you need it.





Colour Range



White



Black



Black Yellow



Blue White



## HIGHSPEED TORPEDO

- Powerful High Speed motor
- Range of unique colours
- Thermal overload protection
- Sturdy construction
- Elegant colour options Black Yellow, Blue White

Sweep (mm)	Power Inputs (Watts)	Speed (RPM)	Air Delivery (CMM)
400	125	2100	105

NEW

Colour Range



Black Red



Black



White Red



White



## GALE PLUS

- High Speed. Best-in-class Air Delivery.
- Wide oscillation with motorised control. Smooth neck tilting. Switch operated oscillation
- Strong base for stability. ABS Blades.
- Thermal overload protection. Finger proof grill.

Sweep (mm)	Power Inputs (Watts)	Speed (RPM)	Air Delivery (CMM)
400	120	2200	120

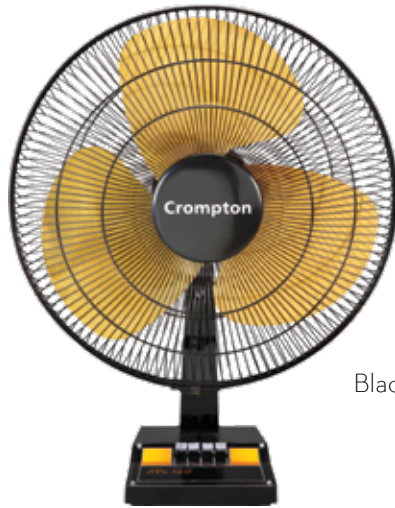

Black Gold

## SDX BLACK GOLD

- Black metal stand & guard, golden colour metal blades

Sweep (mm)	Power Inputs (Watts)	Speed (RPM)	Air Delivery (CMM)
400	54	1360	77



Black

Colour Range



Ash Grey

## WINDMILL

- Unique Windmill like Blade for high performance
- Thermal overload protection for long lasting motor

Sweep (mm)	Power Inputs (Watts)	Speed (RPM)	Air Delivery (CMM)
400	54	1360	77

NEW



Choco Brown

Colour Range



White



Powder Blue

## HIGH FLO WAVE PLUS



- Superior Air Delivery
- Improved blade design
- Thermal overload protection
- Sturdy construction

Sweep (mm)	Power Inputs (Watts)	Speed (RPM)	Air Delivery (CMM)
400	60	1350	85



Crimson Red

Colour Range



White



Coffee



Blue

## HIGH FLO NEO



- PP blade, low noise operation
- Thermal overload protection for long lasting motor
- Smooth oscillation, elegant aesthetic

Sweep (mm)	Power Inputs (Watts)	Speed (RPM)	Air Delivery (CMM)
400	58	1330	85

NEW



Choco brown

Colour Range



White



Powder Blue

TPW

## HIGH FLO WAVE PLUS



- PP blade low noise operation
- Thermal overload protection for long lasting motor
- Smooth oscillation, elegant aesthetic

Sweep (mm)	Power Inputs (Watts)	Speed (RPM)	Air Delivery (CMM)
400	60	1350	85



Coffee

Colour Range



Blue



Red



White

## HIGH FLO NEO



- PP blade, low noise operation
- Thermal overload protection for long lasting motor
- Smooth oscillation, elegant aesthetic

Sweep (mm)	Power Inputs (Watts)	Speed (RPM)	Air Delivery (CMM)
400	58	1330	85

NEW



KD White

TPW

## HIGH FLO WAVE STAR



- PP blade low noise operation
- Thermal overload protection for long lasting motor
- Smooth oscillation, elegant aesthetic

Sweep (mm)	Power Inputs (Watts)	Speed (RPM)	Air Delivery (CMM)
400	60	1350	85





White

Colour Range



Black



Black Yellow



Blue White

## HIGHSPEED TORPEDO



- Powerful High Speed motor
- Range of unique colours
- Thermal overload protection
- Sturdy construction

Sweep (mm)	Power Inputs (Watts)	Speed (RPM)	Air Delivery (CMM)
400	125	2100	105

NEW



Black Red

Colour Range



White



Black



White Red

TPW

## GALE PLUS

- High Speed. Best-in-class Air Delivery.
- Wide oscillation with motorised control. Smooth neck tilting. Switch operated oscillation
- Strong base for stability. ABS Blades.
- Thermal overload protection. Finger proof grill.



Sweep (mm)	Power Inputs (Watts)	Speed (RPM)	Air Delivery (CMM)
400	120	2200	120





Black Gold

## SDX BLACK GOLD

- Metallic sturdy construction, thermal overload protection for long lasting motor
- Royal colour

Sweep (mm)	Power Inputs (Watts)	Speed (RPM)	Air Delivery (CMM)
400	54	1360	77



Silver Black



## SSTORM 2

- High Air Delivery with low noise operation
- Thermal protection for long lasting motor
- Royal finish
- Smooth oscillation



Sweep (mm)	Power Inputs (Watts)	Speed (RPM)	Air Delivery (CMM)
450	90	1350	100



Black

## SUPREMUS

- Adjustable height
- Excellent air throw
- 3 speed operation
- Robust base to ensure absolute stability
- Sturdy powder coated guards to ensure corrosion resistance



Sweep (mm)	Power Inputs (Watts)	Speed (RPM)	Air Delivery (CMM)
400	100	2100	105



Dark Grey

TPW

## BRIZSTAR FARRATA



- Sturdy metallic base
- Anti-rust aluminium blades

Sweep (mm)	Power Inputs (Watts)	Speed (RPM)	Air Delivery (CMH)
500	145	1400	7500

NEW



Choco Brown

Colour Range



White



Powder blue



## HIGH FLO WAVE PLUS

- Superior Air Delivery
- Improved blade design
- Thermal overload protection
- Sturdy construction

Sweep (mm)	Power Inputs (Watts)	Speed (RPM)	Air Delivery (CMM)
400	60	1350	85



Blue

Colour Range



White



Coffee



Red



## HIGH FLO NEO

- PP blade, low noise operation
- Thermal overload protection for long lasting motor
- Smooth oscillation, elegant aesthetic
- Also available in 300mm

Sweep (mm)	Power Inputs (Watts)	Speed (RPM)	Air Delivery (CMM)
400	58	1330	85



White



## HIGHSPEED TORPEDO

- Powerful High Speed motor
- Range of unique colours
- Thermal overload protection
- Sturdy construction
- Also available in 300mm

Sweep (mm)	Power Inputs (Watts)	Speed (RPM)	Air Delivery (CMM)
400	125	2100	105

### Colour Range



Black



Yellow



Blue

NEW



Red Black



## GALE PLUS

- High Speed. Best-in-class Air Delivery.
- Wide oscillation with motorised control. Smooth neck tilting. Switch operated oscillation
- Strong base for stability. ABS Blades.
- Thermal overload protection. Finger proof grill.

Sweep (mm)	Power Inputs (Watts)	Speed (RPM)	Air Delivery (CMM)
400	120	2200	120

### Colour Range

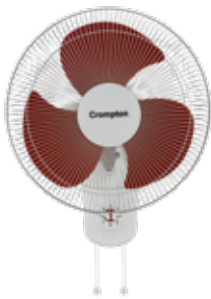

Red White



Black



White



Black Gold

## SDX BLACK GOLD

- Metallic sturdy construction, thermal overload protection for long lasting motor
- Royal colour

Sweep (mm)	Power Inputs (Watts)	Speed (RPM)	Air Delivery (CMM)
400	54	1360	77



Silver Black

## SSTORM 2

- High Air Delivery with Low noise operation
- Thermal protection for long lasting motor
- Royal finish
- Smooth oscillation



Sweep (mm)	Power Inputs (Watts)	Speed (RPM)	Air Delivery (CMM)
450	90	1350	100





# DOMESTIC EXHAUST FANS

Stylish Metallic and ABS body options  
with powerful suction and low noise  
operation





Grey

## TRANSAIR / TRANSAIR REVERSIBLE

- With the flick of a switch one can opt for exhaust mode or fresh air mode in Transair Reversible.
- Bird screen for protection against bird & foreign matter.
- Reversible type available in 225mm & 300mm size only.

Sweep (mm)	Power Inputs (Watts)	Speed (RPM)	Air Delivery (CMH)
150	50	2000	320
225	45	1400	720
300	70	1380	1600

NEW



Grey



## DRIFT AIR PLUS

- Sturdy Metal body with Metal blades.
- Metal bird screen for protection from birds and foreign matter.

\* New variant available with Anti-dust coating

Sweep (mm)	Power Inputs (Watts)	Speed (RPM)	Air Delivery (CMH)
150	42	2300	400
225	38	1370	800
300	50	1350	1160



Grey

## FLUX AIR

- Sturdy metal body with metal blades, corrosion resistant coating on blade and body.
- Plastic bird screen for protection from birds and foreign matter.

Sweep (mm)	Power Inputs (Watts)	Speed (RPM)	Air Delivery (CMH)
225	31	1380	800



White

Colour Range



Wood

## NEW MOUNT AIR

- Lightweight and sleek design with ABS body
- Silent operation and superior air flow
- Can be installed on Glass, Wall and Ceiling
- Also available in Black, Ivory, Brown and Steel colours

Sweep (mm)	Power Inputs (Watts)	Speed (RPM)	Air Delivery (CMH)
100	14	2200	120
150	22	2000	200

DOMESTIC EXHAUST



White

Aerodynamic blades for faster speed



Powerful air suction for odourless and clean air

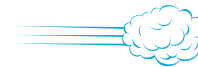

Automatic dust protection shutters for hassle-free hygiene

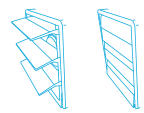

Light and rust proof body for durability



## AXIAL AIR

- Sturdy front grill for additional safety
- Also available in Black, Brown, Ivory

Sweep (mm)	Power Inputs (Watts)	Speed (RPM)	Air Delivery (CMH)
100	12	2400	140
150	20	1750	275

NEW



White

Aerodynamic blades for faster speed



Powerful air suction for odourless and clean air

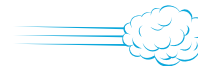

Light and rust proof body for durability



## BRISK AIR NEO

- Sleek design with aerodynamic blades

Sweep (mm)	Power Inputs (Watts)	Speed (RPM)	Air Delivery (CMH)
150	25	1300	275
200	30	1300	450
250	40	1250	720



White

## BRISK AIR PLUS

- Sleek design with aerodynamic blades

Sweep (mm)	Power Inputs (Watts)	Speed (RPM)	Air Delivery (CMH)
150	25	1300	275
200	30	1300	450
250	40	1250	720



White

Aerodynamic blades for faster speed



Powerful air suction for odourless and clean air



Automatic dust protection shutters for hassle-free hygiene

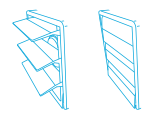

Light and rust proof body for durability



## VENTILUS

- Automatic Shutter for dust protection.
- Also available in Ivory
- White available only in 10"

Sweep (mm)	Power Inputs (Watts)	Speed (RPM)	Air Delivery (CMH)
150	25	1300	275
200	30	1300	450
250	35	1300	900



# OTHER FANS







Grey

## BRASSO

- Excellent air throw
- Rust proof plastic body
- Sleek and sturdy design
- Can be used on wall and cabin



Sweep (mm)	Power Inputs (Watts)	Speed (RPM)	Air Delivery (CMH)
300	90	2200	60



Black

## CITO



- Excellent air throw
- Rust proof plastic body
- Sleek and sturdy design
- Portable and light weight

Sweep (mm)	Power Inputs (Watts)	Speed (RPM)	Air Delivery (CMH)
225	49	2400	28

### Colour Range



White



Blue White



# INDUSTRIAL FANS

Heavy Duty fans with powerful motors and superior air delivery for industrial use

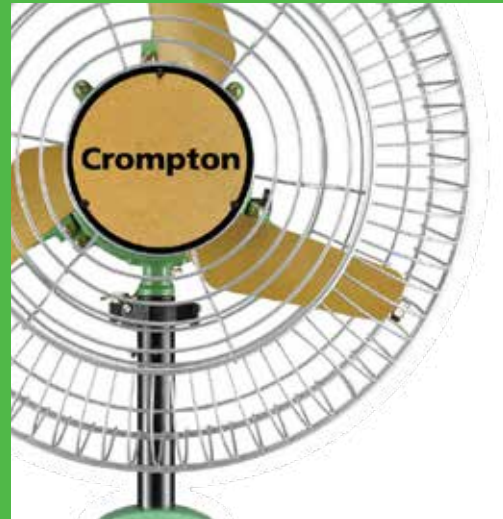
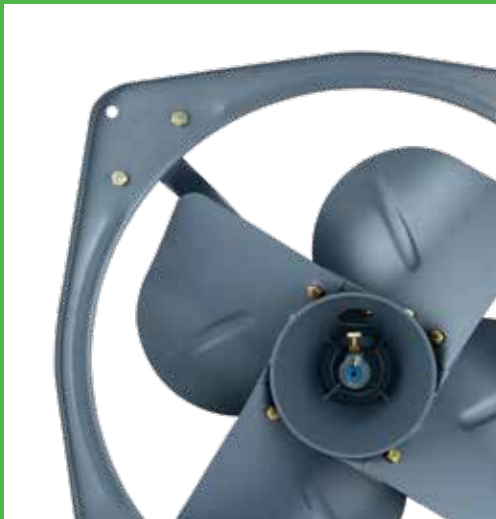



## HEAVY DUTY EXHAUST FANS

- Totally enclosed, continuously rated highly efficient heavy-duty motor with pressure die cast aluminium rotor mounted on two ball bearings.
- Aerodynamically contoured blades handle maximum air with minimum power consumption.
- Rigid frame with rubber mountings for silent operations.
- Epoxy powder coating with specially pretreated components for better resistance to corrosion.
- Degree of protection against dust & water entry is IP55.

### SPECIFICATIONS

Model Name	Impeller Diameter (mm)	Phase	Pole	Power Inputs (Watts)	Speed (RPM)	Air Delivery (CMH)	Current (AMP)	Noise Level (dBA)
EXHD300-4-1 (ISI)*	300	Single	4 Pole	90	1400	1710	0.43	56
EXHD300-6-1 (ISI)	300	Single	6 Pole	55	950	1145	0.26	54
EXHD380-4-1 (ISI)	380	Single	4 Pole	150	1400	3250	0.72	63
EXHD380-4-3	380	Three	4 Pole	150	1400	3250	0.30	63
EXHD380-6-1	380	Single	6 Pole	100	950	2000	0.48	56
EXHD450-4-1 (ISI)*	450	Single	4 Pole	350	1400	6120	1.98	65
EXHD450-4-3	450	Three	4 Pole	350	1400	6120	0.94	65
EXHD450-6-1	450	Single	6 Pole	145	950	3900	0.70	63
EXHD600-6-1	600	Single	6 Pole	550	950	9400	2.65	65
EXHD600-6-3	600	Three	6 Pole	550	950	9400	1.27	65
EXHD900-8-3	900	Three	8 Pole	1200	700	25200	2.60	68

\* Also available in IP65 rating for Industries like Ceramic, Spice, Cement etc.



Pedestal

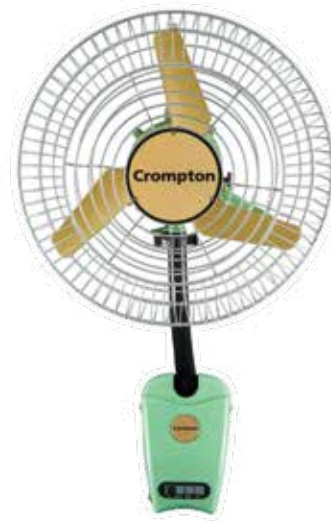

Wall

## VORTEX SERIES (AIR CIRCULATORS)

- Aerodynamically designed blades for higher air delivery
- Heavy duty motor with double ball bearing for longer life
- Oscillation to 85° deg
- Heavy Base for greater stability
- Improved guard design
- Attractive aesthetic to suit your application
- Increase in RPM from 1400 to 1440

450 mm	600 mm	750 mm
Pedestal	Pedestal	Pedestal
Wall	Wall	Wall

### Major Applications

- Railway Stations
- Airports
- Heat Treatment
- Pandal Decorators
- Factories
- Public Places

PERFORMANCE GUIDE





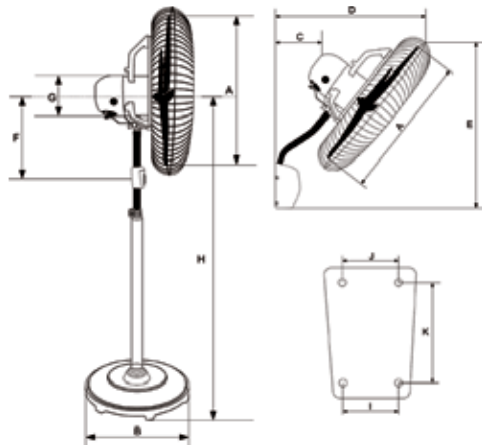

Product ID	Type	Sweep (mm)	Phase	Speed (RPM)	Capacitor (MFD)	Air Delivery (M <sup>3</sup> /H)	Current (AMP)	Power Input (Watts)	Noise Level (dba)	Adjustable height (M)
ACVORTEX18PF	Pedestal	450	Single	1440	3.15	7500	0.45	100	64	1.35 / 1.025
ACVORTEX18WM	Wall	450	Single	1440	3.15	7500	0.45	100	64	
ACVORTEX24PF	Pedestal	600	Single	1440	5	16000	0.95	200	68	1.75 / 1.325
ACVORTEX24WM	Wall	600	Single	1440	5	16000	0.95	200	68	
ACVORTEX30PF	Pedestal	750	Single	1440	5	22200	1.2	250	76	1.75 / 1.325
ACVORTEX30WM	Wall	750	Single	1440	5	22200	1.2	250	76	

\* Rated Voltage 230v. 50Hz AC for single phase 415v. 50Hz for three Phase fans  
 \* Built in Regulator Available only for 450mm sweep

Dimensional Specifications



Model	A	B	H		E		C		D		F	G	I	J	K
			Mini	Max	Mini	Max	Mini	Max	Mini	Max					
VORTEX 450 mm PF	450	450	1135	1200							350	164			
VORTEX 600 mm PF	600	515	1290	1600								164			
VORTEX 750 mm PF	750	515	1290	1600								164			
VORTEX 450 mm WF	450				760	800	70	120	380	450		164	85	115	190
VORTEX 600 mm WF	600				830	870	120	160	530	580		164	85	115	190
VORTEX 750 mm WF	750				1100	1200	120	160	530	580		164	85	115	190

OUR RANGE OF FANS							
SUREBREEZE	✓	✓*					
HIGHSPEED	✓	✓	✓*				
PREMION	✓	✓*	✓*	✓*			✓*
ENERGION	✓	✓	✓*	✓	✓		✓*
SILENTPRO	✓	✓	✓*	✓	✓	✓	✓*
LUXIAN	✓	✓					✓*

\*In select models only.



# Crompton

## CROMPTON GREAVES CONSUMER ELECTRICALS LIMITED

**Registered Office:**

Equinox Business Park, 1st Floor, Tower 3, LBS Marg, Kurla (W), Mumbai - 400 070, India.

**Customer Service:**

Toll free number: **1800 419 0505** (Mon to Sat: 9am - 7pm)

Web registration on [www.crompton.co.in](http://www.crompton.co.in)

Disclaimer - While every effort has been taken to ensure that all specifications and description are correct, this brochure should not be regarded as an infallible guide and not as an offer of sales for a particular product. Due to variables in production process, colours of actual products may vary slightly from those depicted. Model numbers and specifications are for reference only.  
May subject to change without prior notice.